

PRICE ADJUSTMENT

Please check current pricing with your sales representative as some products have incurred price adjustments effective **March 1st, 2014.**



Healthcare Furnishings — List Price Book

A \$25 net handling charge per shipment will be applied for non-UPSable orders of less than \$2,000 list.

Effective January 1, 2017



introduction



GLOBALcare™, a division of The Global Group, manufactures products specifically designed to promote correct body positioning and alignment for an enhanced level of wellness. Products are developed with the highest quality standards in mind to meet the demands of today's hospitals, long-term care facilities and assisted living environments.

With a strong dedication to building quality healthcare furniture that aids both patient care and medical staff, GLOBALcare products, in combination with products from Global, accommodate the healthcare needs of clinical and/or emergency waiting areas, laboratories, patient rooms, resident rooms or administration, nursing stations or lounge areas, lobbies or dining room plus cafeteria areas. Time and time again, GLOBALcare products have proven that they will remain in prime condition for many years, providing good return on investment as well as supporting a health compliant environment.

In the ever-changing world of healthcare, GLOBALcare products are the clear choice for an enhanced level of wellness. We offer strong consulting resources, optimum healthcare furniture solutions and a comprehensive value added program for products and service with our 25 Year Limited Lifetime Warranty. We believe in building long-term relationships and we've proven that GLOBALcare furniture stands the test of time in real life situations while passing strict healthcare guidelines.

GLOBALcare laminate and seating products have been tested using GREENGUARD'S stringent environmental chamber methods and found to meet GREENGUARD's Indoor Air Quality Standards. GREENGUARD Certified products are certified to GREENGUARD standards for low chemical emissions into indoor air during product usage. For more information, visit ul.com/gg.



level™ certification, based on the ANSI/BIFMA e3-2010 furniture sustainability standard, sets furniture manufacturers on a path toward greater sustainability over time. Certification assessment includes an evaluation of specific corporate policies and guidelines and an assessment of associated company manufacturing facilities. Products must meet quantifiable milestones of environmental and social performance at every step of development. The quantitative assessment addresses four categories: material use, energy and atmosphere impacts, human and ecosystem health, and social responsibility.



GLOBALcare USA Showrooms

Marlton, New Jersey
Andover, Massachusetts
Chicago, Illinois
Cincinnati, Ohio
Dallas, Texas
Denver, Colorado

Detroit, Michigan
Duluth, Georgia
Elkridge, Maryland
Fremont, California
Ft. Lauderdale, Florida
Glendale Heights, Illinois

Houston, Texas
Kansas City, Missouri
Leetsdale, Pennsylvania
Minneapolis, Minnesota
New Orleans, Louisiana
New York, New York

Phoenix, Arizona
San Antonio, Texas
Santa Fe Springs, California
St. Louis, Missouri
Sunrise, Florida
Tampa, Florida

TABLE OF CONTENTS

| | | |
|---|--|--|
| <p>A</p> <p>Adeline 55-56</p> <p>Aldon Personal Room Furniture 4-15</p> <p>At-Eez 56-57</p> <p>Aubra 57-61</p> <p>Aubra Tables 30-31, 61</p> | <p>H</p> <p>Heather 105</p> | <p>R</p> <p>Roosevelt 185</p> |
| <p>B</p> <p>Birmingham 62</p> <p>Bishop 62-63</p> | <p>I</p> <p>Interlock 107-128</p> <p>Interlock Tables 38-42, 125-128</p> | <p>S</p> <p>Savannah 186</p> <p>Senator 187</p> <p>Sonoma Personal Room Furniture 16-28</p> <p> Accessory Items 25-28</p> <p> Bedside Cabinets 19-20</p> <p> Desks 25</p> <p> Dressers 20-21</p> <p> Wardrobe Cabinets 22-25</p> <p>Strand 188-194</p> |
| <p>C</p> <p>Careflex 63-66</p> <p>Chapter 67</p> | <p>J</p> <p>Janna 129</p> | |
| <p>D</p> <p>Desmond 68</p> <p>Doctor Buddy 69</p> | <p>K</p> <p>Kensington 131</p> | |
| <p>E</p> <p>Enable Tables 32-33</p> | <p>M</p> <p>Majesty 132</p> | <p>T</p> <p>Tablet Tables 50</p> |
| <p>F</p> <p>Floral Dining Tables 34</p> <p>Frolick, Curtsy, Splash 70-74</p> | <p>N</p> <p>Nourish 134-136</p> | <p>W</p> <p>Wellness 195-198</p> <p>Wingback 198-199</p> |
| <p>G</p> <p>GC-Belong 75-102</p> <p>GC-Belong Tables 35-37, 101-102</p> <p>GC-Comet 103</p> <p>GC-Wind 104</p> | <p>O</p> <p>Occasional Tables 43-49</p> <p>Ottomans 136-137</p> | <p>Y</p> <p>York 199-202</p> |
| | <p>P</p> <p>Pembrooke 137</p> <p>Phoenix 138</p> <p>Primacare Product Map 140-141</p> <p>Primacare 139-154</p> <p>Primacare HT 155-168</p> <p>Primacare Modular 169-184</p> | <p>REFERENCE</p> <p>Seating Application Guidelines 54</p> <p>COM Authorization Form 206</p> <p>Think Global-Think Green 205</p> <p>Textiles & Finishes 204-205</p> <p>Terms/Conditions/Warranty 208-210</p> <p>Index 212+</p> |



aldon + sonoma
personal room furniture





The Aldon series offers affordable and personalized furniture solutions for patient or room spaces. Highly durable, Aldon's clean lines and simple design provide built-in quality to meet the demands within healthcare environments. Tops, gables and backs are all field replaceable to meet future requirements for long term performance. The design incorporates smooth surfaces with a straight profile and durable finish options, demonstrating respect for housekeeping and infection control practices. A 3mm PVC edge on the tops, drawer and door fronts provide peace of mind for greater long-term performance. The vast array of product and finish selections allow for individual choices while complimenting the design objective. Aldon is the ideal balance of value and style.



Features and Benefits

- Tops standard with 1" thermally fused laminate with coordinating 3mm PVC edge
- Chassis, back panels, drawer fronts, shelves and doors are constructed of 11/16" thermally fused laminate
- Laminate finishes are available in a variety of colors
- All chassis panels and tops can be replaced if damaged
- Drawers are mounted on high quality precision steel full extension ball bearing slides
- Handle is standard in attractive, easy-to-grip, arc style. Tungsten (TUN) finish.
- Locks are optional on bedside cabinets, dressers and wardrobes
- Metal Legs and Plinth Bases available on all models
- Casters are available on Bedside cabinets
- For proper ventilation, all units have cut outs with grommets in the back
- GREENGUARD INDOOR AIR QUALITY CERTIFICATION - in compliance with stringent emission guidelines set out by the Greenguard Environmental Institute under the standards for low emitting products and materials. www.greenguard.org.

TOPS

- Tops are field replaceable
- Tops on all models are standard with 1" thermally fused laminate with coordinating 3mm PVC edge.
- 1" high pressure laminate tops with coordinating 3mm PVC edge are available on Bedside Cabinets and dressers. For a quotation, please submit a Special Request Form to your Global representative.

CHASSIS

- Constructed from 11/16" thermally fused laminate.
- Return on investment is enhanced through the ability to replace chassis panels or tops should they become damaged.

BACK

- Back panels are constructed from 11/16" thermally fused laminate
- Back panels are field replaceable should they become damaged

DRAWERS

- Drawer fronts are constructed of 11/16" thermally fused laminate with 3mm PVC edge.
- Mounted on high quality precision steel full extension ball bearing slides.
- Box drawer is 4" high (standard). 6" high box drawer is also available. Please refer to individual models for upcharge.
- On all Bedside Cabinets: 4" high drawer with inside depth 15.09" (standard). Also available in a 6" high drawer box with inside depth 15.48"
- On all Dressers/wardrobes/narrow wardrobes: 4" high drawer box inside depth 15.48" (standard). Also available in a 6" high drawer box inside depth is 15.48"
- Drawer interiors are made of PVC FREE black vinyl particle board

DRAWER INSERTS

- The optional Bedside Cabinet drawer liner insert is constructed of high impact polystyrene, standard in white. Molded in one piece with no seams or joints to collect dust or bacteria, satin smooth and with rounded corners for easy clean up.
- High impact polystyrene insert liner can be removed for ease of room transfer and cleaning.

SHELVING

- Structural fixed shelves and adjustable shelves are constructed of 11/16" thermally fused laminate with coordinating 3mm PVC edge
- Structural fixed shelves and adjustable shelves are supported with metal brackets

DOORS

- Constructed of 11/16" thermally fused laminate with 3mm pvc edge.
- Mounted utilizing commercial quality hinges that provide a 110° opening span for easy access to personal belongings.

LOCKS

- Locks are optional on Bedside Cabinets, dressers and wardrobes. **MUST BE** specified at time of order. Please check each model number for optional locks offered and applicable upcharges.
- Keying is available with random key, please specify **RK**, or keyed alike.
- For key alike numbering sequence, please specify Keys #101 - #120. No upcharge.

EDGE

- Tops, door fronts and drawer fronts have coordinating 3mm PVC edge
- Fixed and adjustable shelves have coordinating 3mm PVC front edge

BASE OPTIONS

- Metal legs, casters and Plinth base are field replaceable and interchangeable on Aldon where applicable.

Metal Legs

- Available on Bedside Cabinets, dressers and wardrobes
- Standard in powder-coated paint finish color: Tungsten (TUN)
- 3"high. Levelers offer .5" to .75" adjustment for increased stability and leveling.

Casters

- Available on Bedside Cabinets only.
- Constructed of commercial quality, swivel dual wheel
- Front casters are manually locking, swivel dual wheel.

Plinth Base

- Available on Bedside Cabinets, dressers and wardrobes
- 3" high and standard in thermally fused laminate
- Levelers offer .5" to .75" adjustment for increased stability and leveling.

HANDLES

- Standard in arc style, Tungsten finish
- Requires a 128mm center point if custom styles are desired

VENTILATION

- All units have cut outs with grommets in the back for ventilation

STANDARD FINISHES

| | |
|-----|--------------------|
| ACJ | Absolute Acajou |
| ASN | Asian Night |
| AWC | Avant Cherry |
| AWH | Avant Honey |
| CSJ | Constellation Java |
| DES | Dark Espresso |
| HGT | Hayden Grey |
| QTM | Quartered Mahogany |
| SKC | Shaker Cherry |
| TFW | Tiger Fruitwood |
| TMA | Tiger Mahogany |
| TMP | Tiger Maple |
| TWL | Tiger Walnut |
| WCR | Winter Cherry |
| WHT | White |
| WHC | White Chocolate |

CUSTOM

- GLOBALcare invites the opportunity to provide quotation on special requests for project business.
- Please contact Customer Care.

SHIPPING

- All products are shipped assembled, one per carton, unless otherwise noted
- Allow 4-6 weeks for delivery

BEDSIDE CABINETS



Bedside Cabinet

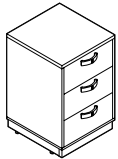

Bedside Cabinet



Bedside Cabinet



Bedside Cabinet

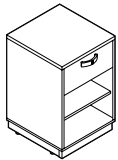

Bedside Cabinet

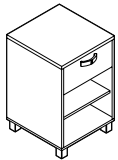

Bedside Cabinet



Bedside Cabinet

| MODEL# | DIMENSIONS | FREIGHT CLASS | WT/LBS. | CUBIC FT. | LIST PRICE |
|--------|------------|---------------|---------|-----------|------------|
|--------|------------|---------------|---------|-----------|------------|

D x W x H

| | | | | | |
|-----------|-----------------|------|----|-----|--------------|
| GCEXBT01C | 20 x 19.25 x 30 | 92.5 | 88 | 9.5 | \$630 |
|-----------|-----------------|------|----|-----|--------------|

Three Drawers on four casters. Standard with no lock.

- For lock on top drawer, specify LK. Add **\$56** list upcharge. Specify random key (RK) or key number 101-120.
- Optional 6"H box drawer - Add **\$70** list upcharge.

| | | | | | |
|-----------|-----------------|------|----|-----|--------------|
| GCEXBT01P | 20 x 19.25 x 30 | 92.5 | 88 | 9.5 | \$644 |
|-----------|-----------------|------|----|-----|--------------|

Three Drawers on plinth base. Standard with no lock.

- For lock on top drawer, specify LK. Add **\$56** list upcharge. Specify random key (RK) or key number 101-120.
- Optional 6"H box drawer - Add **\$70** list upcharge.

| | | | | | |
|-----------|-----------------|------|----|-----|--------------|
| GCEXBT01L | 20 x 19.25 x 30 | 92.5 | 88 | 9.5 | \$689 |
|-----------|-----------------|------|----|-----|--------------|

Three Drawers with metal legs. Standard with no lock.

- For lock on top drawer, specify LK. Add **\$56** list upcharge. Specify random key (RK) or key number 101-120.
- Optional 6"H box drawer - Add **\$70** list upcharge.

| | | | | | |
|-----------|-----------------|-----|----|-----|--------------|
| GCEXBT03C | 20 x 19.25 x 30 | 100 | 88 | 9.5 | \$531 |
|-----------|-----------------|-----|----|-----|--------------|

One drawer and one open 3 position adjustable shelf, on four casters. Standard with no lock.

- For lock on top drawer, specify LK. Add **\$56** list upcharge. Specify random key (RK) or key number 101-120.
- Optional 6"H box drawer - Add **\$24** list upcharge.

| | | | | | |
|-----------|-----------------|-----|----|-----|--------------|
| GCEXBT03P | 20 x 19.25 x 30 | 100 | 88 | 9.5 | \$550 |
|-----------|-----------------|-----|----|-----|--------------|

One drawer and one open 3 position adjustable shelf, on plinth base. Standard with no lock.

- For lock on top drawer, specify LK. Add **\$56** list upcharge. Specify random key (RK) or key number 101-120.
- Optional 6"H box drawer - Add **\$24** list upcharge.

| | | | | | |
|-----------|-----------------|-----|----|-----|--------------|
| GCEXBT03L | 20 x 19.25 x 30 | 100 | 88 | 9.5 | \$585 |
|-----------|-----------------|-----|----|-----|--------------|

One drawer and one open 3 position adjustable shelf, on metal legs. Standard with no lock.

- For lock on top drawer, specify LK. Add **\$56** list upcharge. Specify random key (RK) or key number 101-120.
- Optional 6"H box drawer - Add **\$24** list upcharge.

| | | | | | |
|-----------|-----------------|------|----|-----|--------------|
| GCEXBT04C | 20 x 19.25 x 30 | 92.5 | 88 | 9.5 | \$606 |
|-----------|-----------------|------|----|-----|--------------|

One open fixed shelf and two drawers, on four casters. Standard with no lock.

- For lock on top drawer, specify LK. Add **\$56** list upcharge. Specify random key (RK) or key number 101-120.
- Optional 6"H box drawer - Add **\$47** list upcharge.

BEDSIDE CABINETS

MODEL# DIMENSIONS FREIGHT CLASS WT/LBS. CUBIC FT. LIST PRICE

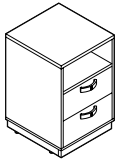

Bedside Cabinet

| D x W x H | | | | | | |
|-----------|-----------------|------|----|-----|--|--------------|
| GCEXBT04P | 20 x 19.25 x 30 | 92.5 | 88 | 9.5 | | \$624 |

One open fixed shelf and two drawers, on plinth base. Standard with no lock.

- For lock on top drawer, specify LK. Add **\$56** list upcharge. Specify random key (RK) or key number 101-120.
- Optional 6"H box drawer - Add **\$47** list upcharge.

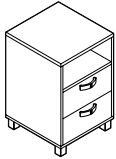

Bedside Cabinet

| | | | | | | |
|-----------|-----------------|------|----|-----|--|--------------|
| GCEXBT04L | 20 x 19.25 x 30 | 92.5 | 88 | 9.5 | | \$661 |
|-----------|-----------------|------|----|-----|--|--------------|

One open fixed shelf and two drawers, with metal legs. Standard with no lock.

- For lock on top drawer, specify LK. Add **\$56** list upcharge. Specify random key (RK) or key number 101-120.
- Optional 6"H box drawer - Add **\$47** list upcharge.

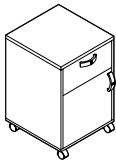

Bedside Cabinet

| | | | | | | |
|------------|-----------------|-----|----|-----|--|--------------|
| GCEXBT06CL | 20 x 19.25 x 30 | 100 | 88 | 9.5 | | \$599 |
|------------|-----------------|-----|----|-----|--|--------------|

Top position drawer, one **LEFT** opening door (hinges on left) with 3 position adjustable shelf behind door, on four casters. Standard with no locks.

- For lock on drawer, specify **LK**. Add **\$56** list upcharge.
- For lock on door, specify **L3**. Add **\$56** list upcharge.
- For locks on drawer and door, specify **L5**. Add **\$112** list upcharge.
- Specify random key (RK) or key number 101-120.
- Optional 6"H box drawer - Add **\$24** list upcharge.

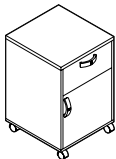

Bedside Cabinet

| | | | | | | |
|------------|-----------------|-----|----|-----|--|--------------|
| GCEXBT06CR | 20 x 19.25 x 30 | 100 | 88 | 9.5 | | \$599 |
|------------|-----------------|-----|----|-----|--|--------------|

Top position drawer, one **RIGHT** opening door (hinges on right) with 3 position adjustable shelf behind door, on four casters. Standard with no locks.

- For lock on drawer, specify **LK**. Add **\$56** list upcharge.
- For lock on door, specify **L4**. Add **\$56** list upcharge.
- For locks on drawer and door, specify **L6**. Add **\$112** list upcharge.
- Specify random key (RK) or key number 101-120.
- Optional 6"H box drawer - Add **\$24** list upcharge.

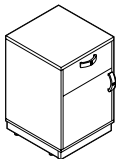

Bedside Cabinet

| | | | | | | |
|------------|-----------------|-----|----|-----|--|--------------|
| GCEXBT06PL | 20 x 19.25 x 30 | 100 | 88 | 9.5 | | \$621 |
|------------|-----------------|-----|----|-----|--|--------------|

Top position drawer, one **LEFT** opening door (hinges on left) with 3 position adjustable shelf behind door, on plinth base. Standard with no locks.

- For lock on drawer, specify **LK**. Add **\$56** list upcharge.
- For lock on door, specify **L3**. Add **\$56** list upcharge.
- For locks on drawer and door, specify **L5**. Add **\$112** list upcharge.
- Specify random key (RK) or key number 101-120.
- Optional 6"H box drawer - Add **\$24** list upcharge.

BEDSIDE CABINETS

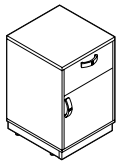

Bedside Cabinet

| MODEL# | DIMENSIONS D x W x H | FREIGHT CLASS | WT/LBS. | CUBIC FT. | LIST PRICE |
|------------|-------------------------|---------------|---------|-----------|--------------|
| GCEXBT06PR | 20 x 19.25 x 30 | 100 | 88 | 9.5 | \$621 |

Top position drawer, one **RIGHT** opening door (hinges on right) with 3 position adjustable shelf behind door, on plinth base. Standard with no locks.

- For lock on drawer, specify **LK**. Add **\$56** list upcharge.
- For lock on door, specify **L4**. Add **\$56** list upcharge.
- For locks on drawer and door, specify **L6**. Add **\$112** list upcharge.
- Specify random key (RK) or key number 101-120.
- Optional 6"H box drawer - Add **\$24** list upcharge.

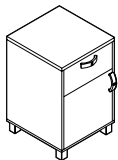

Bedside Cabinet

| | | | | | |
|------------|-----------------|-----|----|-----|--------------|
| GCEXBT06LL | 20 x 19.25 x 30 | 100 | 88 | 9.5 | \$655 |
|------------|-----------------|-----|----|-----|--------------|

Top position drawer, one **LEFT** opening door (hinges on left) with 3 position adjustable shelf behind door, with metal legs. Standard with no locks.

- For lock on drawer, specify **LK**. Add **\$56** list upcharge.
- For lock on door, specify **L3**. Add **\$56** list upcharge.
- For locks on drawer and door, specify **L5**. Add **\$112** list upcharge.
- Specify random key (RK) or key number 101-120.
- Optional 6"H box drawer - Add **\$24** list upcharge.

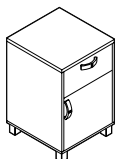

Bedside Cabinet

| | | | | | |
|------------|-----------------|-----|----|-----|--------------|
| GCEXBT06LR | 20 x 19.25 x 30 | 100 | 88 | 9.5 | \$655 |
|------------|-----------------|-----|----|-----|--------------|

Top position drawer, one **RIGHT** opening door (hinges on right) with 3 position adjustable shelf behind door, with metal legs. Standard with no locks.

- For lock on drawer, specify **LK**. Add **\$56** list upcharge.
- For lock on door, specify **L4**. Add **\$56** list upcharge.
- For locks on drawer and door, specify **L6**. Add **\$112** list upcharge.
- Specify random key (RK) or key number 101-120.
- Optional 6"H box drawer - Add **\$24** list upcharge.

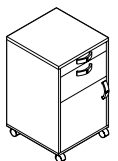

Bedside Cabinet

| | | | | | |
|------------|-----------------|------|----|-----|--------------|
| GCEXBT02CL | 20 x 19.25 x 30 | 92.5 | 87 | 8.5 | \$811 |
|------------|-----------------|------|----|-----|--------------|

Pull out shelf, Top position drawer, one **LEFT** opening door (hinges on left) with 3 position adjustable shelf behind door, on four casters. Standard with no locks.

- For lock on drawer, specify **LK**. Add **\$56** list upcharge.
- For lock on door, specify **L3**. Add **\$56** list upcharge.
- For locks on drawer and door, specify **L5**. Add **\$112** list upcharge.
- Specify random key (RK) or key number 101-120.

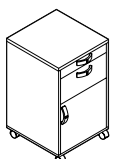

Bedside Cabinet

| | | | | | |
|------------|-----------------|------|----|-----|--------------|
| GCEXBT02CR | 20 x 19.25 x 30 | 92.5 | 87 | 8.5 | \$811 |
|------------|-----------------|------|----|-----|--------------|

Pull out shelf, Top position drawer, one **RIGHT** opening door (hinges on right) with 3 position adjustable shelf behind door, on four casters. Standard with no locks.

- For lock on drawer, specify **LK**. Add **\$56** list upcharge.
- For lock on door, specify **L4**. Add **\$56** list upcharge.
- For locks on drawer and door, specify **L6**. Add **\$112** list upcharge.
- Specify random key (RK) or key number 101-120.

BEDSIDE CABINETS

MODEL# DIMENSIONS FREIGHT CLASS WT/LBS. CUBIC FT. LIST PRICE

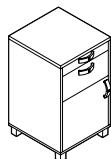

Bedside Cabinet

| D x W x H | | | | | |
|------------|-----------------|------|----|-----|--------------|
| GCEXBT02LL | 20 x 19.25 x 30 | 92.5 | 87 | 8.5 | \$880 |

Pull out shelf, Top position drawer, one **LEFT** opening door (hinges on left) with 3 position adjustable shelf behind door, with metal legs. Standard with no locks.

- For lock on drawer, specify **LK**. Add **\$56** list upcharge.
- For lock on door, specify **L3**. Add **\$56** list upcharge.
- For locks on drawer and door, specify **L5**. Add **\$112** list upcharge.
- Specify random key (RK) or key number 101-120.

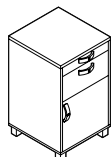

Bedside Cabinet

| | | | | | |
|------------|-----------------|------|----|-----|--------------|
| GCEXBT02LR | 20 x 19.25 x 30 | 92.5 | 87 | 8.5 | \$880 |
|------------|-----------------|------|----|-----|--------------|

Pull out shelf, Top position drawer, one **RIGHT** opening door (hinges on right) with 3 position adjustable shelf behind door, with metal legs. Standard with no locks.

- For lock on drawer, specify **LK**. Add **\$56** list upcharge.
- For lock on door, specify **L4**. Add **\$56** list upcharge.
- For locks on drawer and door, specify **L6**. Add **\$112** list upcharge.
- Specify random key (RK) or key number 101-120.

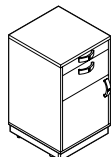

Bedside Cabinet

| | | | | | |
|------------|-----------------|------|----|-----|--------------|
| GCEXBT02PL | 20 x 19.25 x 30 | 92.5 | 87 | 8.5 | \$852 |
|------------|-----------------|------|----|-----|--------------|

Pull out shelf, Top position drawer, one **LEFT** opening door (hinges on left) with 3 position adjustable shelf behind door, on plinth base. Standard with no locks.

- For lock on drawer, specify **LK**. Add **\$56** list upcharge.
- For lock on door, specify **L3**. Add **\$56** list upcharge.
- For locks on drawer and door, specify **L5**. Add **\$112** list upcharge.
- Specify random key (RK) or key number 101-120.

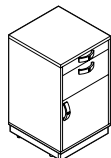

Bedside Cabinet

| | | | | | |
|------------|-----------------|------|----|-----|--------------|
| GCEXBT02PR | 20 x 19.25 x 30 | 92.5 | 87 | 8.5 | \$852 |
|------------|-----------------|------|----|-----|--------------|

Pull out shelf, Top position drawer, one **RIGHT** opening door (hinges on right) with 3 position adjustable shelf behind door, on plinth base. Standard with no locks.

- For lock on drawer, specify **LK**. Add **\$56** list upcharge.
- For lock on door, specify **L4**. Add **\$56** list upcharge.
- For locks on drawer and door, specify **L6**. Add **\$112** list upcharge.
- Specify random key (RK) or key number 101-120.

DRESSERS

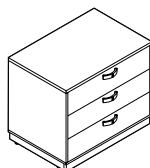

3 Drawer Dresser

| | | | | | |
|-----------|----------------|-----|-----|------|--------------|
| GCEXDR02P | 24 x 35.5 x 30 | 125 | 130 | 19.5 | \$778 |
|-----------|----------------|-----|-----|------|--------------|

Three drawers on plinth base. Standard with no lock.

- For lock on top drawer, specify **LK**. Add **\$56** list upcharge.
- Optional 6" H box drawer - Add **\$70** list upcharge.

DRESSERS

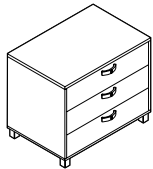

3 Drawer Dresser

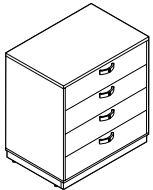

4 Drawer Dresser

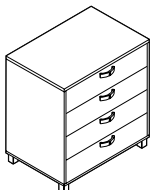

4 Drawer Dresser

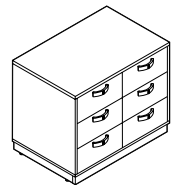

Double Dresser

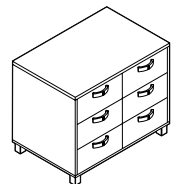

Double Dresser

| MODEL# | DIMENSIONS | FREIGHT CLASS | WT/LBS. | CUBIC FT. | LIST PRICE |
|--------|------------|---------------|---------|-----------|------------|
|--------|------------|---------------|---------|-----------|------------|

D x W x H

| | | | | | |
|-----------|----------------|-----|-----|------|--------------|
| GCEXDR02L | 24 x 35.5 x 30 | 125 | 130 | 19.5 | \$834 |
|-----------|----------------|-----|-----|------|--------------|

Three drawers on metal legs. Standard with no lock.

- For lock on top drawer, specify **LK**. Add **\$56** list upcharge.
- Optional 6"H box drawer - Add **\$70** list upcharge.

| | | | | | |
|-----------|------------------|-----|-----|------|--------------|
| GCEXDR07P | 24 x 35.5 x 38.5 | 125 | 140 | 24.5 | \$933 |
|-----------|------------------|-----|-----|------|--------------|

Four drawers on plinth base. Standard with no lock.

- For lock on top drawer, specify **LK**. Add **\$56** list upcharge.
- Optional 6"H box drawer - Add **\$93** list upcharge.

| | | | | | |
|-----------|------------------|-----|-----|------|--------------|
| GCEXDR07L | 24 x 35.5 x 38.5 | 125 | 140 | 24.5 | \$960 |
|-----------|------------------|-----|-----|------|--------------|

Four drawers on metal legs. Standard with no lock.

- For lock on top drawer, specify **LK**. Add **\$56** list upcharge.
- Optional 6"H box drawer - Add **\$93** list upcharge.

| | | | | | |
|-----------|------------------|-----|-----|------|--------------|
| GCEXDD01P | 24 x 35.5 x 38.5 | 100 | 140 | 24.5 | \$984 |
|-----------|------------------|-----|-----|------|--------------|

Three drawers on each side, on plinth base. Standard with no locks.

- For lock on top right drawer, specify **LR**. Add **\$56** list upcharge.
- For lock on top left drawer, specify **LL**. Add **\$56** list upcharge.
- For lock on top right and left drawers, specify **LB**. Add **\$112** list upcharge.
- Specify random key (RK) or key number 101-120.
- Optional 6"H box drawer - Add **\$139** list upcharge.

| | | | | | |
|-----------|------------------|-----|-----|------|---------------|
| GCEXDD01L | 24 x 35.5 x 38.5 | 100 | 140 | 24.5 | \$1040 |
|-----------|------------------|-----|-----|------|---------------|

Three drawers on each side, on metal legs. Standard with no locks.

- For lock on top right drawer, specify **LR**. Add **\$56** list upcharge.
- For lock on top left drawer, specify **LL**. Add **\$56** list upcharge.
- For lock on top right and left drawers, specify **LB**. Add **\$112** list upcharge.
- Specify random key (RK) or key number 101-120.
- Optional 6"H box drawer - Add **\$139** list upcharge.

WARDROBE CABINETS

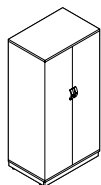

Wardrobe Cabinet

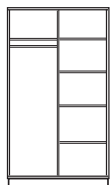

| MODEL# | DIMENSIONS | FREIGHT CLASS | WT/LBS. | CUBIC FT. | LIST PRICE |
|--------|------------|---------------|---------|-----------|------------|
|--------|------------|---------------|---------|-----------|------------|

D x W x H

| | | | | | |
|-----------|----------------|-----|-----|----|--------|
| GCEXWD03P | 24 x 35.5 x 72 | 125 | 280 | 44 | \$1504 |
|-----------|----------------|-----|-----|----|--------|

Divided wardrobe with coat rail and shelves, on plinth base. Two doors covering interior divided in two with an upper fixed shelf and coat rail on the left side. The right side has 4 adjustable shelves. Two Anti-tip brackets are included for greater security. Standard with no lock.

Inside Dimensions:

- LEFT Side Top Shelf: 12.85"
- LEFT Side Coat Rod Area: 53.2"
- RIGHT Side Coat Rail Area: 66.59"
- For one lock fastening both doors, specify **LB**. Add **\$56** list upcharge. Specify random key (RK) or key number 101-120.

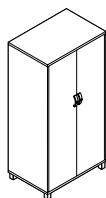

Wardrobe Cabinet

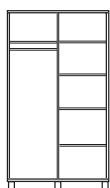

| | | | | | |
|-----------|----------------|-----|-----|----|--------|
| GCEXWD03L | 24 x 35.5 x 72 | 125 | 280 | 44 | \$1529 |
|-----------|----------------|-----|-----|----|--------|

Divided wardrobe with coat rail and shelves, on 5 metal legs. Two doors covering interior divided in two with an upper fixed shelf and coat rail on the left side. The right side has 4 adjustable shelves. Two Anti-tip brackets are included for greater security. Standard with no lock.

Inside Dimensions:

- LEFT Side Top Shelf: 12.85"
- LEFT Side Coat Rod Area: 53.2"
- RIGHT Side Coat Rail Area: 66.59"
- For one lock fastening both doors, specify **LB**. Add **\$56** list upcharge. Specify random key (RK) or key number 101-120.

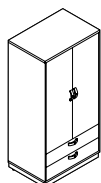

Wardrobe Cabinet

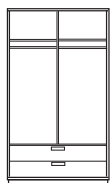

| | | | | | |
|-----------|----------------|-----|-----|----|--------|
| GCEXWD04P | 24 x 35.5 x 72 | 125 | 290 | 44 | \$1622 |
|-----------|----------------|-----|-----|----|--------|

Divided wardrobe with coat rail and two full drawers below, on plinth base. Two doors covering interior divided in two with an upper fixed shelf and coat rail on both sides. Two exposed drawers below. Two Anti-tip brackets are included for greater security. Standard with no locks.

Inside Dimensions:

- LEFT Side Top Shelf: 7" LEFT Side Coat Rod Area: 42"
- RIGHT Side Top Shelf: 7" RIGHT Side Coat Rod Area: 42"
- Top Drawer: 8.25" Lower Drawer: 8.25"
- For lock on right door, specify **L4**. Add **\$56** list upcharge.
- For lock on left door, specify **L3**. Add **\$56** list upcharge.
- For lock on both right and left doors, specify **L2**. Add **\$112** list upcharge.
- For lock on top drawer, specify **LK**. Add **\$56** list upcharge.
- For lock on right door and top drawer, specify **L6**. Add **\$112** list upcharge.
- For lock on left door and top drawer, specify **L5**. Add **\$112** list upcharge.
- For lock on right door, left door and top drawer, specify **L9**. Add **\$167** list upcharge.
- Specify random key (RK) or key number 101-120.
- Optional 6"H box drawer - Add **\$47** list upcharge.

WARDROBE CABINETS

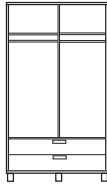
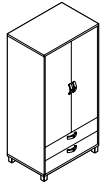

Wardrobe Cabinet

| MODEL# | DIMENSIONS D x W x H | FREIGHT CLASS | WT/LBS. | CUBIC FT. | LIST PRICE |
|-----------|-------------------------|---------------|---------|-----------|---------------|
| GCEXWD04L | 24 x 35.5 x 72 | 125 | 290 | 44 | \$1644 |

Divided wardrobe with coat rail and two full drawers below, on 5 metal legs. Two doors covering interior divided in two with an upper fixed shelf and coat rail on both sides. Two exposed drawers below. Two Anti-tip brackets are included for greater security. Standard with no locks.

Inside Dimensions:

- LEFT Side Top Shelf: 7" LEFT Side Coat Rod Area: 42"
- RIGHT Side Top Shelf: 7" RIGHT Side Coat Rod Area: 42"
- Top Drawer: 8.25" Lower Drawer: 8.25"
- For lock on right door, specify **L4**. Add **\$56** list upcharge.
- For lock on left door, specify **L3**. Add **\$56** list upcharge.
- For lock on both right and left doors, specify **L2**. Add **\$112** list upcharge.
- For lock on top drawer, specify **LK**. Add **\$56** list upcharge.
- For lock on right door and top drawer, specify **L6**. Add **\$112** list upcharge.
- For lock on left door and top drawer, specify **L5**. Add **\$112** list upcharge.
- For lock on right door, left door and top drawer, specify **L9**. Add **\$167** list upcharge.
- Specify random key (RK) or key number 101-120.
- Optional 6"H box drawer - Add **\$47** list upcharge.

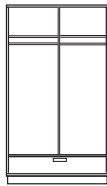
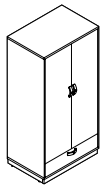

Wardrobe Cabinet

| | | | | | |
|-----------|----------------|-----|-----|----|---------------|
| GCEXWD05P | 24 x 35.5 x 72 | 125 | 290 | 44 | \$1559 |
|-----------|----------------|-----|-----|----|---------------|

Divided wardrobe with coat rails and one full drawer below, on plinth base. Two doors covering interior divided in two with an upper fixed shelf and coat rail on both sides. One exposed drawer below. Two Anti-tip brackets are included for greater security. Standard with no locks.

Inside Dimensions:

- LEFT Side Top Shelf: 7" LEFT Side Coat Rod Area: 50.4"
- RIGHT Side Top Shelf: 7" RIGHT Side Coat Rod Area: 50.4"
- Drawer: 8.25"
- For lock on right door, specify **L4**. Add **\$56** list upcharge.
- For lock on left door, specify **L3**. Add **\$56** list upcharge.
- For lock on both right and left doors, specify **L2**. Add **\$112** list upcharge.
- For lock on drawer, specify **LK**. Add **\$56** list upcharge.
- For lock on right door and drawer, specify **L6**. Add **\$112** list upcharge.
- For lock on left door and drawer, specify **L5**. Add **\$112** list upcharge.
- For locks on right door, left door and drawer, specify **L9**. Add **\$167** list upcharge.
- Specify random key (RK) or key number 101-120.
- Optional 6"H box drawer - Add **\$24** list upcharge.

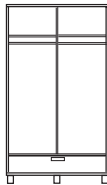
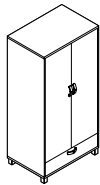

Wardrobe Cabinet

| | | | | | |
|-----------|----------------|-----|-----|----|---------------|
| GCEXWD05L | 24 x 35.5 x 72 | 125 | 290 | 44 | \$1585 |
|-----------|----------------|-----|-----|----|---------------|

Divided wardrobe with coat rails and one full drawer below, on 5 metal legs. Two doors covering interior divided in two with an upper fixed shelf and coat rail on both sides. One exposed drawer below. Two Anti-tip brackets are included for greater security. Standard with no locks.

Inside Dimensions:

- LEFT Side Top Shelf: 7" LEFT Side Coat Rod Area: 50.4"
- RIGHT Side Top Shelf: 7" RIGHT Side Coat Rod Area: 50.4"
- Drawer: 8.25"
- For lock on right door, specify **L4**. Add **\$56** list upcharge.
- For lock on left door, specify **L3**. Add **\$56** list upcharge.
- For lock on both right and left doors, specify **L2**. Add **\$112** list upcharge.
- For lock on drawer, specify **LK**. Add **\$56** list upcharge.
- For lock on right door and drawer, specify **L6**. Add **\$112** list upcharge.
- For lock on left door and drawer, specify **L5**. Add **\$112** list upcharge.
- For locks on right door, left door and drawer, specify **L9**. Add **\$167** list upcharge.
- Specify random key (RK) or key number 101-120.
- Optional 6"H box drawer - Add **\$24** list upcharge.

WARDROBE CABINETS

MODEL# DIMENSIONS FREIGHT CLASS WT/LBS. CUBIC FT. LIST PRICE

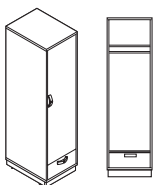

Narrow Wardrobe Cabinet

| D x W x H | | | | | | |
|------------|----------------|-----|-----|----|--|---------------|
| GCEXWN01PR | 24 x 18.5 x 72 | 150 | 120 | 25 | | \$1212 |

Narrow wardrobe with coat rail and drawer below, on plinth base. One **RIGHT** door (hinged on the right) covering upper fixed shelf and coat rail. One exposed drawer below. Two Anti-tip brackets are included for greater security. Standard with no locks.

Inside Dimensions:

- Top Shelf: 7" Coat Rail Area: 50.4" Drawer: 8.25"
- For lock on drawer, specify **LK**. Add **\$56** list upcharge.
- For lock on door, specify **L4**. Add **\$56** list upcharge.
- For locks on door and drawer, specify **L6**. Add **\$112** list upcharge.
- Specify random key (RK) or key number 101-120.
- Optional 6"H box drawer - Add **\$24** list upcharge.

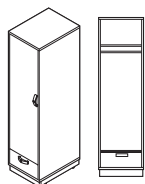

Narrow Wardrobe Cabinet

| | | | | | | |
|------------|----------------|-----|-----|----|--|---------------|
| GCEXWN01PL | 24 x 18.5 x 72 | 150 | 120 | 25 | | \$1212 |
|------------|----------------|-----|-----|----|--|---------------|

Narrow wardrobe with coat rail and drawer below, on plinth base. One **LEFT** door (hinged on the left) covering upper fixed shelf and coat rail. One exposed drawer below. Two Anti-tip brackets are included for greater security. Standard with no locks.

Inside Dimensions:

- Top Shelf: 7" Coat Rail Area: 50.4" Drawer: 8.25"
- For lock on drawer, specify **LK**. Add **\$56** list upcharge.
- For lock on door, specify **L3**. Add **\$56** list upcharge.
- For locks on door and drawer, specify **L5**. Add **\$112** list upcharge.
- Specify random key (RK) or key number 101-120.
- Optional 6"H box drawer - Add **\$24** list upcharge.

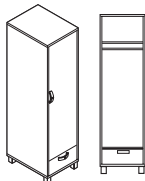

Narrow Wardrobe Cabinet

| | | | | | | |
|------------|----------------|-----|-----|----|--|---------------|
| GCEXWN01LR | 24 x 18.5 x 72 | 150 | 120 | 25 | | \$1250 |
|------------|----------------|-----|-----|----|--|---------------|

Narrow wardrobe with coat rail and drawer below, on 4 metal legs. One **RIGHT** door (hinged on the right) covering upper fixed shelf and coat rail. One exposed drawer below. Two Anti-tip brackets are included for greater security. Standard with no locks.

Inside Dimensions:

- Top Shelf: 7" Coat Rail Area: 50.4" Drawer: 8.25"
- For lock on drawer, specify **LK**. Add **\$56** list upcharge.
- For lock on door, specify **L4**. Add **\$56** list upcharge.
- For locks on door and drawer, specify **L6**. Add **\$112** list upcharge.
- Specify random key (RK) or key number 101-120.
- Optional 6"H box drawer - Add **\$24** list upcharge.

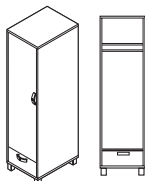

Narrow Wardrobe Cabinet

| | | | | | | |
|------------|----------------|-----|-----|----|--|---------------|
| GCEXWN01LL | 24 x 18.5 x 72 | 150 | 120 | 25 | | \$1250 |
|------------|----------------|-----|-----|----|--|---------------|

Narrow wardrobe with coat rail and drawer below, on 4 metal legs. One **LEFT** door (hinged on the left) covering upper fixed shelf and coat rail. One exposed drawer below. Two Anti-tip brackets are included for greater security. Standard with no locks.

Inside Dimensions:

- Top Shelf: 7" Coat Rail Area: 50.4" Drawer: 8.25"
- For lock on drawer, specify **LK**. Add **\$56** list upcharge.
- For lock on door, specify **L3**. Add **\$56** list upcharge.
- For locks on door and drawer, specify **L5**. Add **\$112** list upcharge.
- Specify random key (RK) or key number 101-120.
- Optional 6"H box drawer - Add **\$24** list upcharge.

WARDROBE CABINETS

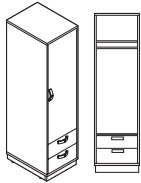

Narrow Wardrobe Cabinet

| MODEL# | DIMENSIONS D x W x H | FREIGHT CLASS | WT/LBS. | CUBIC FT. | LIST PRICE |
|------------|-------------------------|---------------|---------|-----------|---------------|
| GCEXWN02PR | 24 x 18.5 x 72 | 150 | 120 | 25 | \$1272 |

Narrow wardrobe with coat rail and 2 drawers below, on plinth base. One **RIGHT** door (hinged on the right) covering upper fixed shelf and coat rail. Two exposed drawers below. Two Anti-tip brackets are included for greater security. Standard with no locks.

Inside Dimensions:

- Top Shelf: 7" Coat Rail Area: 42" Top Drawer: 8.25" Lower Drawer: 8.25"
- For lock on top drawer, specify **LK**. Add **\$56** list upcharge.
- For lock on door, specify **L4**. Add **\$56** list upcharge.
- For locks on door and top drawer, specify **L6**. Add **\$112** list upcharge.
- Specify random key (RK) or key number 101-120.
- Optional 6"H box drawer - Add **\$47** list upcharge.

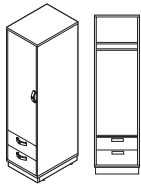

Narrow Wardrobe Cabinet

| | | | | | |
|------------|----------------|-----|-----|----|---------------|
| GCEXWN02PL | 24 x 18.5 x 72 | 150 | 120 | 25 | \$1272 |
|------------|----------------|-----|-----|----|---------------|

Narrow wardrobe with coat rail and 2 drawers below, on plinth base. One **LEFT** door (hinged on the left) covering upper fixed shelf and coat rail. Two exposed drawers below. Two Anti-tip brackets are included for greater security. Standard with no locks.

Inside Dimensions:

- Top Shelf: 7" Coat Rail Area: 42" Top Drawer: 8.25" Lower Drawer: 8.25"
- For lock on top drawer, specify **LK**. Add **\$56** list upcharge.
- For lock on door, specify **L3**. Add **\$56** list upcharge.
- For locks on door and top drawer, specify **L5**. Add **\$112** list upcharge.
- Specify random key (RK) or key number 101-120.
- Optional 6"H box drawer - Add **\$47** list upcharge.

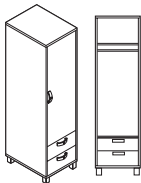

Narrow Wardrobe Cabinet

| | | | | | |
|------------|----------------|-----|-----|----|---------------|
| GCEXWN02LR | 24 x 18.5 x 72 | 150 | 120 | 25 | \$1311 |
|------------|----------------|-----|-----|----|---------------|

Narrow wardrobe with coat rail and 2 drawers below, on 4 metal legs. One **RIGHT** door (hinged on the right) covering upper fixed shelf and coat rail. Two exposed drawers below. Two Anti-tip brackets are included for greater security. Standard with no locks.

Inside Dimensions:

- Top Shelf: 7" Coat Rail Area: 42" Top Drawer: 8.25" Lower Drawer: 8.25"
- For lock on top drawer, specify **LK**. Add **\$56** list upcharge.
- For lock on door, specify **L4**. Add **\$56** list upcharge.
- For locks on door and top drawer, specify **L6**. Add **\$112** list upcharge.
- Specify random key (RK) or key number 101-120.
- Optional 6"H box drawer - Add **\$47** list upcharge.

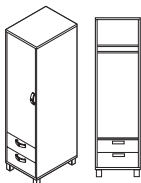

Narrow Wardrobe Cabinet

| | | | | | |
|------------|----------------|-----|-----|----|---------------|
| GCEXWN02LL | 24 x 18.5 x 72 | 150 | 120 | 25 | \$1311 |
|------------|----------------|-----|-----|----|---------------|

Narrow wardrobe with coat rail and 2 drawers below, on 4 metal legs. One **LEFT** door (hinged on the left) covering upper fixed shelf and coat rail. Two exposed drawers below. Two Anti-tip brackets are included for greater security. Standard with no locks.

Inside Dimensions:

- Top Shelf: 7" Coat Rail Area: 42" Top Drawer: 8.25" Lower Drawer: 8.25"
- For lock on top drawer, specify **LK**. Add **\$56** list upcharge.
- For lock on door, specify **L3**. Add **\$56** list upcharge.
- For locks on door and top drawer, specify **L5**. Add **\$112** list upcharge.
- Specify random key (RK) or key number 101-120.
- Optional 6"H box drawer - Add **\$47** list upcharge.

WARDROBE CABINETS

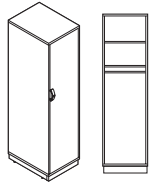

Narrow Wardrobe Cabinet

| MODEL# | DIMENSIONS | FREIGHT CLASS | WT/LBS. | CUBIC FT. | LIST PRICE |
|------------------|----------------|---------------|---------|-----------|---------------|
| D x W x H | | | | | |
| GCEXWN03PR | 24 x 18.5 x 72 | 150 | 120 | 25 | \$1142 |

Narrow wardrobe with shelves and coat rail, on plinth base. One **RIGHT** door (hinged on the right) covering interior with one 3 position adjustable shelf and a fixed shelf above the coat rail. Two Anti-tip brackets are included for greater security. Standard with no lock.

Inside Dimensions:

- Adjustable Shelf: 11.69" Fixed Shelf: 11.69" Coat Rail area: 42"
- For lock on door, specify **L4**. Add **\$56** list upcharge.

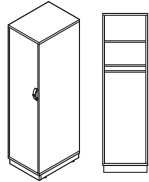

Narrow Wardrobe Cabinet

| | | | | | |
|------------|----------------|-----|-----|----|---------------|
| GCEXWN03PL | 24 x 18.5 x 72 | 150 | 120 | 25 | \$1142 |
|------------|----------------|-----|-----|----|---------------|

Narrow wardrobe with shelves and coat rail, on plinth base. One **LEFT** door (hinged on the left) covering interior with one 3 position adjustable shelf and a fixed shelf above the coat rail. Two Anti-tip brackets are included for greater security. Standard with no lock.

Inside Dimensions:

- Adjustable Shelf: 11.69" Fixed Shelf: 11.69" Coat Rail area: 42"
- For lock on door, specify **L3**. Add **\$56** list upcharge.

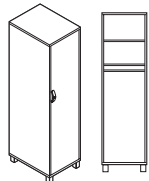

Narrow Wardrobe Cabinet

| | | | | | |
|------------|----------------|-----|-----|----|---------------|
| GCEXWN03LR | 24 x 18.5 x 72 | 150 | 120 | 25 | \$1191 |
|------------|----------------|-----|-----|----|---------------|

Narrow wardrobe with shelves and coat rail, on metal legs. One **RIGHT** door (hinged on the right) covering interior with one 3 position adjustable shelf and a fixed shelf above the coat rail. Two Anti-tip brackets are included for greater security. Standard with no lock.

Inside Dimensions:

- Adjustable Shelf: 11.69" Fixed Shelf: 11.69" Coat Rail area: 42"
- For lock on door, specify **L4**. Add **\$56** list upcharge.

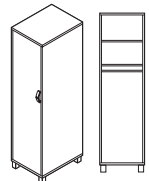

Narrow Wardrobe Cabinet

| | | | | | |
|------------|----------------|-----|-----|----|---------------|
| GCEXWN03LL | 24 x 18.5 x 72 | 150 | 120 | 25 | \$1191 |
|------------|----------------|-----|-----|----|---------------|

Narrow wardrobe with shelves and coat rail, on metal legs. One **LEFT** door (hinged on the left) covering interior with one 3 position adjustable shelf and a fixed shelf above the coat rail. Two Anti-tip brackets are included for greater security. Standard with no lock.

Inside Dimensions:

- Adjustable Shelf: 11.69" Fixed Shelf: 11.69" Coat Rail area: 42"
- For lock on door, specify **L3**. Add **\$56** list upcharge.

ACCESSORIES

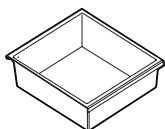

Bedside Drawer Liner

| | | | | | |
|-----------|-------------------|----|---|---|-------------|
| GCEXLLP01 | 15.5 x 16.5 x 4.5 | 70 | 1 | 1 | \$75 |
|-----------|-------------------|----|---|---|-------------|

High impact polystyrene insert liner for Bedside Cabinet drawers. Can be removed for ease of room transfer and cleaning.



Features and Benefits

- Tops for units 37.5" or lower are constructed with 1" high pressure laminate
- Tops for units above 37.5" in height and structural fixed shelves are constructed of 1" thermally fused laminate
- Chassis, back panels, drawer fronts, adjustable shelves, doors and fascia profiles are constructed of 3/4" thermally fused laminate
- 3mm polymer edge with top over side panel design
- Laminate finishes are available in a variety of colors
- All chassis panels and tops can be replaced if damaged
- Drawers are mounted on high quality precision steel full extension ball bearing slides
- Locks are optional on the top drawer position of all units
- Aluminum Extrusions, Legs and Plastic Parts are available in seven paint finishes
- Casters are available on Bedside units
- Handles are offered in five styles
- Decorative fascia designs are available in four styles
- GREENGUARD INDOOR AIR QUALITY CERTIFICATION - in compliance with stringent emission guidelines set out by the Greenguard Environmental Institute under the standards for low emitting products and materials. www.greenguard.org.

Offers superior construction detail in an extensive selection of furniture pieces to fit the personal storage requirements of various lifestyle environments including Long Term Care, Retirement, Senior Living Residences and Hospitals.

Features distinctive Aluminum Extrusions on all leading corners allowing for a continuous connection of chassis panels from top to bottom providing enhanced performance and durability. The Aluminum Extrusions offer increased protection from the impact of mobile equipment and furniture used in demanding healthcare environments.

Products have ventilation and drainage features built into the unique design providing air circulation and drainage where required. Products are freestanding with under unit clearance for cleaning access.

Features decorative fascia options for enhancing the decor of any environment with the additional benefit of providing a safety guard to prevent items from falling behind units.

Wardrobe cabinets offer a Safety Garment Hook with a safety feature to support a maximum of 75 lbs. The Safety Coat Rail ensures maximum well being and peace of mind from accidents.

Multiple needs and requirements are met with the several styles and variety of interior configurations.

ACCESSORY ITEMS

- A complementary line of accessories is available to complete and enhance any room setting.
- Bookcases offer the same superior construction utilizing the Aluminum Extrusions on each corner and are available in several heights.
- A locking memory box is available with a glass front and 3 adjustable shelves allowing for personalized arrangement of possessions.
- Framed mirrors, Whiteboard and Tackboard options offer a bottom ledge and are available with the decorative fascia to complement room furniture.

TOPS

- Units of 37.5" or lower are constructed with 1" high pressure laminate with coordinating 3mm polymer edge.
- Units above 37.5" in height are constructed with 1" thermally fused laminate with coordinating 3mm polymer edge.

CHASSIS

- Constructed from 3/4" thermally fused laminate.
- Connected using Aluminum Extrusions allowing for a continuous connection top to bottom.
- Return on investment is enhanced through the ability to replace chassis panels or tops should they become damaged.

BACK

- Back panels are constructed from 3/4" thermally fused laminate.

DRAWERS

- Drawer fronts are constructed of 3/4" thermally fused laminate with 3mm PVC edge.
- Mounted on high quality precision steel full extension ball bearing slides.
- Drawer depth is determined by the individual product size:
20" deep cabinets feature 15.5" drawers.
22" and 26" deep products feature 17.25" drawers.
- Drawer interiors are fully wrapped in a durable vinyl covering, color is French Vanilla. This vinyl wrap offers superior durability and performance in a demanding environment.

DRAWER INSERTS

- The optional Bedside cabinet drawer liner insert and personal organizer tray sets are constructed of high impact styrene plastic, color is French Vanilla. See Accessories for purchase information.
- High impact styrene plastic liners have been specially designed to saddle the drawer edges for a perfect fit while eliminating gaps and potential traps.
- High impact styrene plastic insert liner and organizer tray set can be removed for ease of room transfer and cleaning.

SHELVING

- Structural fixed shelves are constructed of 1" thermally fused laminate with coordinating self edge.
- Adjustable shelves are constructed of 3/4" thermally fused laminate with coordinating self edge.
- Shelf pins are offered for securing shelf with self drilling screws to prevent accidental movement.

DOORS

- Constructed of 3/4" thermally fused laminate with 3mm PVC edge.
- Mounted utilizing commercial quality hinges that provide a 170° opening span for easy access to personal belongings.

LOCKS

- A lock is optional on the top drawer position of all units with drawers. **MUST BE** specified at time of order.
- Random keying will be provided as standard when locks are ordered.
- For key alike numbering sequence. Please specify Keys #401 - #440.
- For specifying lock on top drawer, indicate "**LS**" (lock set) after model number and **Add \$46** upcharge.

ALUMINUM EXTRUSIONS/LEGS/PLASTIC PARTS

- Aluminum Extrusions form the structural integrity of the product, ensuring a continuous solid connection for the unit chassis as well as providing leg support.
- The Aluminum Extrusion Connection/Leg is extended to allow clearance under each unit for access during cleaning.
- The Aluminum Extrusion Connection/Leg is standard with Charcoal color plastic glide and a Non-Marking leveller.
- Levellers offer 0.5" adjustment for increased stability and levelling.
- Standard powder coat paint finishes are Sierra (**SC**), Nevada (**NV**), Silver (**SL**), Black (**BK**), Taupe (**TP**), Tungsten (**TN**) and Charcoal (**CG**). Finish **MUST BE** specified at the time of order.
- Custom powder coated paint finishes are available. Please contact your GLOBALcare representative for further details.
- Please visit www.thinkglobalcare.com, go to "Forms" and complete the Special Product Request Application. Submit to your GLOBALcare representative.

CASTERS

- Available only on specific units.
- Products allowing use of casters are identified by the product code followed by a "C".
- Casters **MUST BE** specified at the time of order. Casters can not be retrofitted in the field.
- Casters are commercial quality, swivel dual wheel manual locking.

HANDLES

- Offered in five styles.
- Handles require a 128mm center point if custom styles are desired,
- Handle style **MUST BE** specified at the time of order.



A1
Arc - Sierra



B1
Bow - Matte Chrome

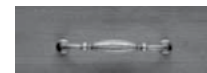

B5
Bon-Bon - Burnished Brass



CF
Curl - Pewter



D3
Dome - Natural Iron

- Handles can be ordered separately. Specify **GC-A1**: Arc - Sierra, **GC-B1**: Bow - Matte Chrome, **GC-B5**: Bon-Bon - Burnished Brass, **GC-CF**: Curl - Pewter, **GC-D3**: Dome - Natural Iron. **Add \$18**.
- For additional finish options, please contact your GLOBALcare representative.
- To view the GLOBALcare Handle Finish options, visit www.thinkglobalcare.com under "Textile and Finishes".

S SONOMA - NOTES

DECORATIVE FASCIA OPTIONS

- Select from four fascia styles to create the room theme of your choice.
- Used to complement the decor and style within the room and are offered in the same laminate finish as the specified unit.
- Fascia profiles are constructed of 3/4" thermally fused laminate, with all leading edges offering a coordinating self edge finish.
- Decorative fascia profiles are affixed to the top and bottom of each unit.
- Top fascia keeps items from falling off the back of the unit. The top fascia profile is installed on site.
- Fascia style **MUST BE** specified at the time of order.

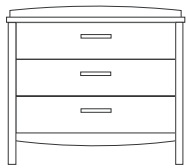

Arc (AR)

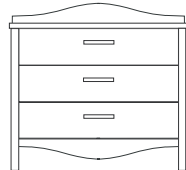

Wave (WV)

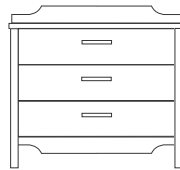

Scallop (SL)

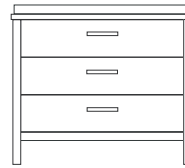

Linear (LN)

- Custom designed fascia options are available, please contact your GLOBALcare representative.

TOP & CHASSIS SURFACE OPTIONS

- All laminate finishes are available with coordinating 3mm polymer edge:
- | | | | |
|-----|-----------------|-----|-----------------|
| ACJ | Absolute Acajou | ASN | Asian Night |
| AWC | Avant Cherry | AHB | Avant Honey |
| BLK | Black | CMB | Clear Maple |
| DES | Dark Espresso | DWT | Designer White |
| EMB | Empire Mahogany | HGT | Hayden Grey |
| RCL | River Cherry | SSL | Satin Stainless |
| SKB | Shaker Cherry | SOG | Storm Grey |
| TMP | Tiger Maple | TWL | Tiger Walnut |
| WHC | White Chocolate | | |

CUSTOM

- GLOBALcare invites the opportunity to provide quotation on special requests for project business.
- Please visit www.thinkglobalcare.com, go to "Forms" and complete the Product Special Request Application. Submit to your GLOBALcare representative.

SHIPPING

- All products are shipped partially assembled, one per carton, unless otherwise noted. Fascia, shelves and accessories are to be installed on site.
- All freight charges are prepaid and added to the invoice.

BEDSIDE CABINETS

Notes - PLEASE SPECIFY all substitutions and options

- Bedside cabinets incorporate the unique Aluminum Extrusion Connection/Leg construction.
- The Aluminum Extrusion offers superior strength and durability from impact with mobile equipment and furniture used in the space.
- Ventilation openings have been strategically incorporated into each unit where needed.
- See the 'General Information' section for details on tops, chassis, finish and detail selections.
- **MUST Specify detail information at the time of order. See pages 17-18.**
 1. Laminate Finish
 2. Aluminum Extrusion/Leg Paint Finish
 3. Handle Style and Finish
 4. Fascia Profile
- An optional Key Lock is available for top drawer position **ONLY** and **must be specified at the time of order**.
- To specify lock on top drawer, indicate "**LS**" (lock set) after model number. **Add \$46** list upcharge.
- Casters are available as specified on models and cannot be retrofitted in the field.

BEDSIDE CABINETS MODEL# DIMENSIONS FREIGHT CLASS WT/LBS. CUBIC FT. LIST PRICE

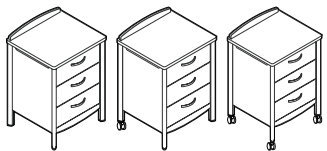

BEDSIDE CABINET

| | D x W x H | | | | |
|-----------------------------------|------------------|-----|-----|----|---------------|
| GCLBT01N | 20.5 x 22.5 x 30 | 100 | 97 | 11 | \$1089 |
| GCLBT01CN (with rear casters) | 20.5 x 22.5 x 30 | 100 | 100 | 11 | \$1146 |
| GCLBT014CN (with four casters) | 20.5 x 22.5 x 30 | 100 | 100 | 11 | \$1248 |

Three Drawers.
 • Model GCLBT01CN has 2 manual locking swivel casters on back.
 • Model GCLBT014CN has 4 manual locking swivel casters.

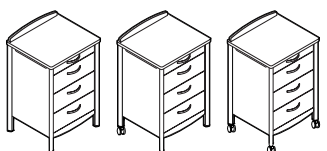

BEDSIDE CABINET

| | | | | | |
|------------------------------------|--------------------|-----|-----|----|---------------|
| GCLBT01SN | 20.5 x 22.5 x 34.5 | 100 | 104 | 11 | \$1387 |
| GCLBT01CSN (with rear casters) | 20.5 x 22.5 x 34.5 | 100 | 107 | 11 | \$1437 |
| GCLBT014CSN (with four casters) | 20.5 x 22.5 x 34.5 | 100 | 108 | 11 | \$1488 |

Three Drawers and one pull out shelf.
 • Model GCLBT01CSN has 2 manual locking swivel casters on back.
 • Model GCLBT014CSN has 4 manual locking swivel casters.

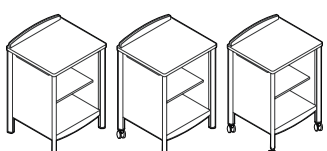

BEDSIDE CABINET

| | | | | | |
|----------------------------------|------------------|-----|----|----|--------------|
| GCLBT02N | 20.5 x 22.5 x 30 | 150 | 58 | 11 | \$631 |
| GCLBT02CN (with rear casters) | 20.5 x 22.5 x 30 | 150 | 60 | 11 | \$675 |
| GCLBT024CN (with casters) | 20.5 x 22.5 x 30 | 150 | 60 | 11 | \$776 |

One adjustable shelf.
 • Model GCLBT02CN has 2 manual locking swivel casters on back.
 • Model GCLBT024CN has 4 manual locking swivel casters.

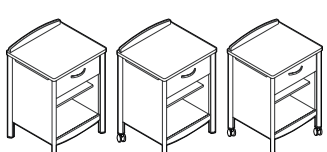

BEDSIDE CABINET

| | | | | | |
|----------------------------------|------------------|-----|----|----|--------------|
| GCLBT03N | 20.5 x 22.5 x 30 | 125 | 76 | 11 | \$795 |
| GCLBT03CN (with rear casters) | 20.5 x 22.5 x 30 | 125 | 78 | 11 | \$848 |
| GCLBT034CN (with casters) | 20.5 x 22.5 x 30 | 125 | 78 | 11 | \$949 |

One drawer, one adjustable shelf.
 • Model GCLBT03CN has 2 manual locking swivel casters on back.
 • Model GCLBT034CN has 4 manual locking swivel casters.

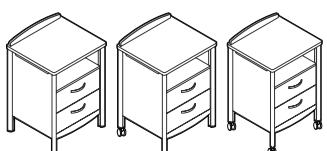

BEDSIDE CABINET

| | | | | | |
|----------------------------------|------------------|-----|----|----|---------------|
| GCLBT04N | 20.5 x 22.5 x 30 | 100 | 90 | 11 | \$973 |
| GCLBT04CN (with rear casters) | 20.5 x 22.5 x 30 | 100 | 92 | 11 | \$1016 |
| GCLBT044CN (with casters) | 20.5 x 22.5 x 30 | 100 | 92 | 11 | \$1118 |

One fixed shelf, two drawers.
 • Model GCLBT04CN has 2 manual locking swivel casters on back.
 • Model GCLBT044CN has 4 manual locking swivel casters.

S SONOMA

BEDSIDE CABINETS

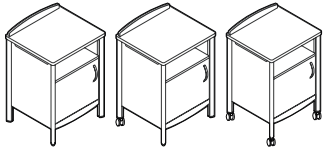

BEDSIDE CABINET

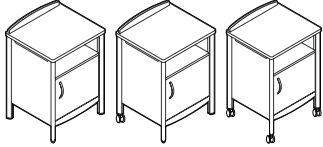

BEDSIDE CABINET

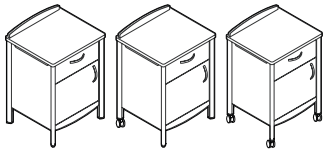

BEDSIDE CABINET

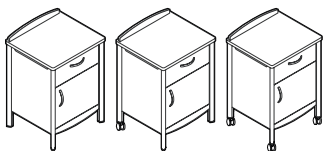

BEDSIDE CABINET

| MODEL# | DIMENSIONS | FREIGHT CLASS | WT/LBS. | CUBIC FT. | LIST PRICE |
|--------|------------|---------------|---------|-----------|------------|
|--------|------------|---------------|---------|-----------|------------|

D x W x H

| | | | | | |
|-----------------------------------|------------------|-----|----|----|--------------|
| GCLBT05LN | 20.5 x 22.5 x 30 | 125 | 74 | 11 | \$829 |
| GCLBT05CLN (with rear casters) | 20.5 x 22.5 x 30 | 125 | 77 | 11 | \$872 |
| GCLBT05L4CN (with casters) | 20.5 x 22.5 x 30 | 125 | 77 | 11 | \$973 |

One fixed shelf, one **LEFT** opening door with adjustable shelf.

- Model GCLBT05CLN has 2 manual locking swivel casters on back.
- Model GCLBT05L4CN has 4 manual locking swivel casters.

| | | | | | |
|-----------------------------------|------------------|-----|----|----|--------------|
| GCLBT05RN | 20.5 x 22.5 x 30 | 125 | 74 | 11 | \$829 |
| GCLBT05CRN (with rear casters) | 20.5 x 22.5 x 30 | 125 | 77 | 11 | \$872 |
| GCLBT05R4CN | 20.5 x 22.5 x 30 | 125 | 77 | 11 | \$973 |

One fixed shelf, one **RIGHT** opening door with adjustable shelf.

- Model GCLBT05CRN has 2 manual locking swivel casters on back.
- Model GCLBT05R4CN has 4 manual locking swivel casters.

| | | | | | |
|-----------------------------------|------------------|-----|----|----|---------------|
| GCLBT06LN | 20.5 x 22.5 x 30 | 125 | 82 | 11 | \$992 |
| GCLBT06CLN (with rear casters) | 20.5 x 22.5 x 30 | 125 | 84 | 11 | \$1040 |
| GCLBT06L4CN (with casters) | 20.5 x 22.5 x 30 | 125 | 82 | 11 | \$1142 |

Top position drawer, one **LEFT** opening door with adjustable shelf.

- Model GCLBT06CLN has 2 manual locking swivel casters on back.
- Model GCLBT06L4CN has 4 manual locking swivel casters.

| | | | | | |
|-----------------------------------|------------------|-----|----|----|---------------|
| GCLBT06RN | 20.5 x 22.5 x 30 | 125 | 82 | 11 | \$992 |
| GCLBT06CRN (with rear casters) | 20.5 x 22.5 x 30 | 125 | 84 | 11 | \$1040 |
| GCLBT06R4CN (with casters) | 20.5 x 22.5 x 30 | 125 | 84 | 11 | \$1142 |

Top position drawer, one **RIGHT** opening door with adjustable shelf.







- Model GCLBT06CRN has 2 manual locking swivel casters on back.
- Model GCLBT06R4CN has 4 manual locking swivel casters.

DRESSERS

Notes:

PLEASE SPECIFY all substitutions and options

- Dresser units incorporate the unique Aluminum Extrusion Connection/Leg construction.
- The Aluminum Extrusion offers superior strength and durability from impact with the mobile equipment and furniture used in the space.
- Ventilation openings have been strategically incorporated into each unit where needed.
- See the 'General Information' section for details on tops, chassis, finish and detail selections.
- **MUST Specify detail information at the time of order. See pages 17-18.**
 1. Laminate Finish
 2. Aluminum Extrusion/Leg Paint Finish
 3. Handle Style and Finish
 4. Fascia Profile
- An optional Key Lock is available for top drawer position **ONLY** and must be specified at the time of order.
- To specify lock on top drawer, indicate "**LS**" (lock set) after model number. **Add \$46.** list upcharge.

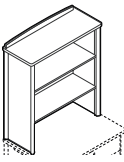
| DRESSERS | MODEL# | DIMENSIONS D x W x H | FREIGHT CLASS | WT/LBS. | CUBIC FT. | LIST PRICE |
|---|----------|-------------------------|---------------|---------|-----------|---|
|  | GCLDR01N | 26.5 x 34.5 x 30 | 125 | 152 | 22 | \$1459 |
| 26" Deep Dresser | | | | | | Three drawers. |
|  | GCLDR02N | 22.5 x 34.5 x 30 | 125 | 142 | 20 | \$1406 |
| 22" Deep Dresser | | | | | | Three drawers. |
|  | GCLDR07N | 26.5 x 34.5 x 37.5 | 125 | 186 | 27 | \$1820 |
| 26" Deep Dresser | | | | | | Four drawers. |
|  | GCLDR04N | 22.5 x 34.5 x 37.5 | 125 | 174 | 24 | \$1768 |
| 22" Deep Dresser | | | | | | Four drawers. |
|  | GCLDR05N | 26.5 x 34.5 x 37.5 | 125 | 178 | 27 | \$1671 |
| 26" Deep Dresser | | | | | | Three drawers with open storage space above. Cord access in back. |
|  | GCLDR06N | 22.5 x 34.5 x 37.5 | 125 | 166 | 24 | \$1604 |
| 22" Deep Dresser | | | | | | Three drawers with open storage space above. Cord access in back. |
|  | GCLDR03N | 14.5 x 34.5 x 42 | 150 | 90 | 16 | \$973 |
| Hutch For 30" High Dresser | | | | | | Shelving unit for placement on 30" high dresser (overall height 72"). Hutch has one adjustable and one fixed shelf. Wire management grommet provides easy access for cables. Hutch utilizes the Aluminum Extrusion connection technology. For greater security, the Anti-Tip Security Kit is recommended on units above 60". See Accessory Items. |

DRESSERS **MODEL#** **DIMENSIONS** **FREIGHT CLASS** **WT/LBS.** **CUBIC FT.** **LIST PRICE**

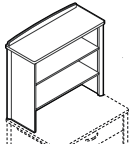

Hutch For 37.5" High Dresser

D x W x H

| | | | | | |
|----------|--------------------|-----|----|----|--------------|
| GCLDR08N | 14.5 x 34.5 x 34.5 | 150 | 83 | 15 | \$848 |
|----------|--------------------|-----|----|----|--------------|

Shelving unit for placement on 37.5" high dresser (overall height 72"). Hutch has one adjustable and one fixed shelf. Wire management grommet provides easy access for cables. Hutch utilizes the Aluminum Extrusion connection technology. For greater security, the Anti-Tip Security Kit is recommended on units above 60". See Accessory Items.



Double Dresser

| | | | | | |
|----------|------------------|-----|-----|----|---------------|
| GCLDD01N | 26.5 x 66.5 x 30 | 125 | 283 | 40 | \$3299 |
|----------|------------------|-----|-----|----|---------------|

Double dresser with three drawers. 26" deep at each side.

WARDROBE CABINETS **MODEL#** **DIMENSIONS** **FREIGHT CLASS** **WT/LBS.** **CUBIC FT.** **LIST PRICE**

Notes:
PLEASE SPECIFY all substitutions and options

- Wardrobe cabinets incorporate the unique Aluminum Extrusion Connection/Leg construction.
- The Aluminum Extrusion offers superior strength and durability from impact with the mobile equipment and furniture used in the space.
- Doors are mounted utilizing commercial quality hinges that provide a 170° opening span for comfortable access to personal belongings.
- Ventilation and draining have been strategically incorporated into each unit where needed.
- Wardrobe cabinets offer a Safety Garment Hook as standard and a Safety Coat Rail to ensure maximum well being and peace of mind from accidents.
- See notes section for details on tops, chassis, finish and detail selections.
- **MUST Specify detail information at the time of order. See pages 17-18.**
 1. Laminate Finish
 2. Aluminum Extrusion/Leg Paint Finish
 3. Handle Style and Finish
 4. Fascia Profile
- **Optional door lock is available. MUST be quoted on a project opportunity as a special.**
- See accessories for additional options to enhance personal storage features.

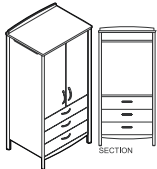

Storage Wardrobe Cabinet, Hinged Doors

| | | | | | |
|----------|------------------|-----|-----|----|---------------|
| GCLWA01N | 26.5 x 34.5 x 72 | 150 | 274 | 55 | \$3101 |
|----------|------------------|-----|-----|----|---------------|

72" high combination unit with 170° hinged doors and 3 drawers. Inside configuration has a Safety Coat Rail. For greater security, the Anti-Tip Security Kit is recommended on units above 60". See Accessory Items.

- Top Shelf: 25.625"D x 30.75"W
- Coat rod area: 30.75"W
- Opening: 23.25"D x 30.75"W x 29"H
- *Lock not available on door.*

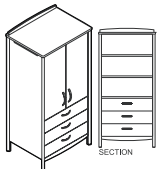



Storage Wardrobe Cabinet, Hinged Doors

| | | | | | |
|----------|------------------|-----|-----|----|---------------|
| GCLWA02N | 26.5 x 34.5 x 72 | 150 | 312 | 55 | \$3299 |
|----------|------------------|-----|-----|----|---------------|

72" high combination unit with 170° hinged doors and 3 drawers. Inside configuration has 2 adjustable shelves. For greater security, the Anti-Tip Security Kit is recommended on units above 60". See Accessory Items.

- Top section with adjustable shelves: 25.625"D x 30.75"W x 41"H
- Opening: 23.25"D x 30.75"W x 29"H
- *Lock not available on door.*

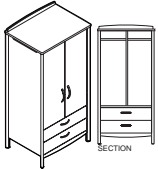
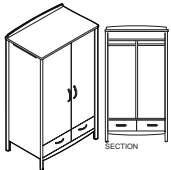
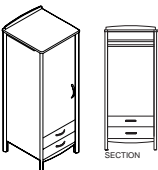
| WARDROBE CABINETS | MODEL# | DIMENSIONS D x W x H | FREIGHT CLASS | WT/LBS. | CUBIC FT. | LIST PRICE |
|--|----------|-------------------------|---------------|---------|-----------|---|
|  <p>Open Wardrobe Cabinet</p> | GCLWA03N | 26.5 x 34.5 x 72 | 150 | 300 | 55 | \$2600 |
| | | | | | | <p>Open front wardrobe with coat rail and three full drawers below. Safety Coat Rail below a fixed shelf. Three exposed drawers below. For greater security, the Anti-Tip Security Kit is recommended on units above 60". See Accessory Items.</p> <ul style="list-style-type: none"> • Top Shelf: 25.625"D x 30.75"W x 8.625"H • Coat rod area: 30.75"W • Full drawer: 5.125"D x 28"W x 17"L |
|  <p>Open Wardrobe Cabinet</p> | GCLWA04N | 26.5 x 34.5 x 72 | 60 | 300 | 55 | \$2798 |
| | | | | | | <p>Open front wardrobe with coat rail and two adjustable shelves and three full drawers below. For greater security, the Anti-Tip Security Kit is recommended on units above 60". See Accessory Items.</p> <ul style="list-style-type: none"> • Top section with adjustable shelves: 25.625"D x 30.75"W x 41"H • Full drawer: 5.125"D x 28"W x 17"L |
|  <p>Divided Wardrobe Cabinet</p> | GCLWG01N | 26.5 x 34.5 x 72 | 150 | 294 | 55 | \$2899 |
| | | | | | | <p>Two doors covering interior divided in two with upper shelf and Safety Coat Rail on both right and left sides. Two exposed drawers below. A Safety Garment Hook is standard on the cabinet interior door. For greater security, the Anti-Tip Security Kit is recommended on units above 60". See Accessory Items.</p> <ul style="list-style-type: none"> • LEFT Side Top Shelf: 24.625"D x 15"W x 8.625"H • RIGHT Side Top Shelf: 24.625"D x 15"W x 8.625"H • Top Drawer: 5.125"D x 28"W x 17"L • LEFT Side Coat Rod Area: 15"W • RIGHT Side Coat Rod Area: 15"W • Lower Drawer: 5.125"D x 28"W x 17"L |
|  <p>Divided Wardrobe Cabinet</p> | GCLWG02N | 26.5 x 41.25 x 72 | 150 | 312 | 66 | \$3202 |
| | | | | | | <p>Two doors covering interior divided in two with upper shelf and Safety Coat Rail on both right and left sides. One exposed drawer on each right and left side below. A Safety Garment Hook is standard on the cabinet interior door. For greater security, the Anti-Tip Security Kit is recommended on units above 60". See Accessory Items.</p> <ul style="list-style-type: none"> • LEFT Side Top Shelf: 24.625"D x 16.75"W x 8.625"H • LEFT Side Coat Rod Area: 16.75"W • LEFT Drawer: 5.125"D x 16.5"W x 15.5"L • RIGHT Side Top Shelf: 24.625"D x 16.75"W x 8.625"H • RIGHT Side Coat Rod Area: 16.75"W • RIGHT Drawer: 5.125"D x 16.5"W x 15.5"L |
|  <p>Narrow Wardrobe Cabinet</p> | GCLWN01N | 24.5 x 22.5 x 72 | 125 | 216 | 30 | \$2297 |
| | | | | | | <p>One door covering upper shelf and Safety Coat Rail. Two exposed drawers below. For greater security, the Anti-Tip Security Kit is recommended on units above 60". See Accessory Items.</p> <p>Inside Dimensions:</p> <ul style="list-style-type: none"> • Top Shelf: 22.625"D x 18.25"W • Coat Rod Area: 18.25"W • Top Drawer: 5.125"D x 16.5"W x 15.5"L • Lower Drawer: 5.125"D x 16.5"W x 15.5"L |

WARDROBE CABINETS

MODEL# DIMENSIONS FREIGHT CLASS WT/LBS. CUBIC FT. LIST PRICE

D x W x H

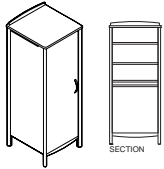

Narrow Wardrobe Cabinet

| | | | | | |
|----------|------------------|-----|-----|----|---------------|
| GCLWN02N | 24.5 x 22.5 x 72 | 150 | 274 | 55 | \$1950 |
|----------|------------------|-----|-----|----|---------------|

One door covering interior with two adjustable shelves, a fixed shelf and Safety Coat Rail. For greater security, the Anti-Tip Security Kit is recommended on units above 60". See Accessory Items.
 Inside Dimensions: 22.25"D x 18.25"W x 72"H

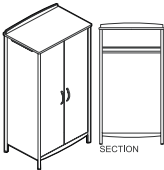

Wardrobe Cabinet

| | | | | | |
|----------|------------------|-----|-----|----|---------------|
| GCLWD01N | 26.5 x 38.5 x 72 | 150 | 262 | 55 | \$2427 |
|----------|------------------|-----|-----|----|---------------|

Two doors, full span Safety Coat Rail below a fixed shelf. A Safety Garment Hook is standard on the cabinet interior door. For greater security, the Anti-Tip Security Kit is recommended on units above 60". See Accessory Items.
 Inside Dimensions:

- Top Shelf: 22.75"D x 34"W x 8.625"H
- Bottom Portion: 22.75"D x 34"W x 55.75"H
- *Not available with a lock.*

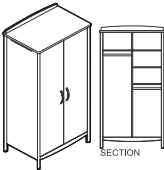

Wardrobe Cabinet

| | | | | | |
|----------|------------------|-----|-----|----|---------------|
| GCLWD02N | 26.5 x 38.5 x 72 | 150 | 283 | 55 | \$2788 |
|----------|------------------|-----|-----|----|---------------|

Two doors. Interior is divided in two with an upper shelf and a Safety Coat Rail on the **LEFT** side. The **RIGHT** side has 1 adjustable and 2 fixed shelves with a Safety Coat Rail below. A Safety Garment Hook is standard on the cabinet interior door. For greater security, the Anti-Tip Security Kit is recommended on units above 60". See Accessory Items.

Inside Dimensions:

- LEFT Side Top Shelf: 20.75"D x 17"W x 8.625"H
- LEFT Side Coat Rod Area: 20.75"D x 17"W x 55.75"H
- RIGHT Side Top Shelf: 20.75"D x 17"W x 8.625"H
- RIGHT Side Coat Rod Area: 20.75"D x 17"W x 36.75"H

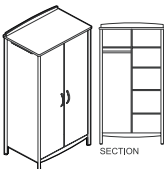

Wardrobe Cabinet

| | | | | | |
|----------|------------------|-----|-----|----|---------------|
| GCLWD03N | 26.5 x 38.5 x 72 | 150 | 298 | 55 | \$2995 |
|----------|------------------|-----|-----|----|---------------|

Two doors. Interior is divided in two with an upper shelf and a Safety Coat Rail on the LEFT side. The RIGHT side has 2 adjustable and 2 fixed shelves. A Safety Garment Hook is standard on the cabinet interior door. For greater security, the Anti-Tip Security Kit is recommended on units above 60". See Accessory Items.

Inside Dimensions:

- LEFT Side Top Shelf: 20.75"D x 17"W x 8.625"H
- LEFT Side Coat Rod Area: 20.75"D x 17"W x 55.75"H
- RIGHT Side Top Shelf: 20.75"D x 17"W x 8.625"H
- RIGHT Side Middle Section w/Adjustable Shelf: 20.75"D x 17"W x 36.25"H
- RIGHT Side Bottom Section: 22.75"D x 17"W x 18.75"H

WARDROBE CABINETS **MODEL#** **DIMENSIONS** **FREIGHT CLASS** **WT/LBS.** **CUBIC FT.** **LIST PRICE**

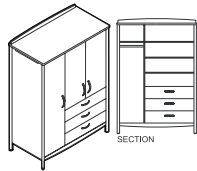

Wardrobe Cabinet

| | | | | | |
|----------|------------------|-----|-----|----|---------------|
| GCLWC01N | 26.5 x 50.5 x 72 | 125 | 444 | 71 | \$3857 |
|----------|------------------|-----|-----|----|---------------|

Three doors. Interior LEFT side offers an upper shelf with a Safety Coat Rail below. The RIGHT side of the cabinet has 2 half length doors with 2 fixed and 2 adjustable shelves. Three drawers below. A Safety Garment Hook is standard on the cabinet interior door. For greater security, the Anti-Tip Security Kit is recommended on units above 60". See Accessory Items. Inside Dimensions:

- LEFT Side Top Shelf: 20.75"D x 14.75"W x 8.625"H
- LEFT Side Coat Rod Area: 22.75"D x 14.75"W x 55.75"H
- RIGHT Side Top Shelf: 20.75"D x 30.75"W x 8.625"H
- To specify lock on top drawer only, indicate "**LS**" (lock set) after model number. **Add \$46** list upcharge.
- RIGHT Side Middle Section w/Adjustable Shelf: 20.75"D x 30.75"W x 36.25"H
- RIGHT Side Bottom Section: 20.75"D x 30.75"W x 18.75"H

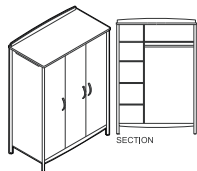

Wardrobe Cabinet

| | | | | | |
|----------|------------------|-----|-----|----|---------------|
| GCLWC02N | 26.5 x 50.5 x 72 | 125 | 430 | 71 | \$3477 |
|----------|------------------|-----|-----|----|---------------|

Three full length doors. Interior LEFT side offers 2 adjustable and 2 fixed shelves. Interior RIGHT side offers an upper shelf with a Safety Coat Rail below. A Safety Garment Hook is standard on the cabinet interior door. For greater security, the Anti-Tip Security Kit is recommended on units above 60". See Accessory Items.

Inside Dimensions:

- LEFT Side Top Shelf: 20.75"D x 14.75"W x 8.625"H
- LEFT Side Middle Section w/Adjustable Shelf: 20.75"D x 14.75"W x 35.75"H
- LEFT Side Bottom Section: 20.75"D x 14.75"W x 19"H
- RIGHT Side Top Shelf: 20.75"D x 30.75"W x 8.625"H
- RIGHT Side Coat Rod Area: 22.75"D x 30.75"W x 55.75"H

DESKS **MODEL#** **DIMENSIONS** **FREIGHT CLASS** **WT/LBS.** **CUBIC FT.** **LIST PRICE**

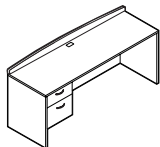

Single Pedestal Desk

| | | | | | |
|----------|--------------|-----|-----|----|---------------|
| GCLDK01N | 24 x 48 x 29 | 125 | 210 | 27 | \$2399 |
|----------|--------------|-----|-----|----|---------------|

Box/File Pedestal on the left. Grommet in worksurface.

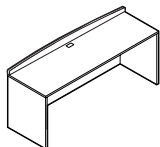

Desk Shell

| | | | | | |
|----------|--------------|----|-----|---|---------------|
| GCLDK02N | 24 x 48 x 29 | 70 | 105 | 6 | \$1247 |
|----------|--------------|----|-----|---|---------------|



Grommet in worksurface.

ACCESSORY ITEMS **MODEL#** **DIMENSIONS** **FREIGHT CLASS** **WT/LBS.** **CUBIC FT.** **LIST PRICE**

Notes:
PLEASE SPECIFY all substitutions and options

- Bookcase units incorporate the unique Aluminum Extrusion Connection/Leg construction.
- The Aluminum Extrusion offers superior strength and durability from impact with the mobile equipment and furniture used in the space.
- See construction details for information on tops, chassis, finish and detail selections.
- MUST Specify detail information at the time of order. See pages 17-18.
 1. Laminate Finish
 2. Aluminum Extrusion/Leg Paint Finish
 3. Fascia Profile

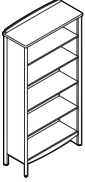
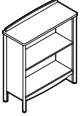
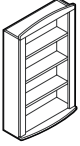
S SONOMA

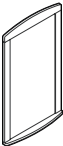
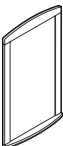
| ACCESSORY ITEMS | MODEL# | DIMENSIONS D x W x H | FREIGHT CLASS | WT/LBS. | CUBIC FT. | LIST PRICE |
|---|------------------------------|-------------------------|---------------|---------|-----------|---------------|
|  Bookcase | GCLBC01N | 14.5 x 34.5 x 72 | 150 | 143 | 29 | \$1459 |
| 72" High. 3 adjustable shelves and 1 fixed. For greater security, the Anti-Tip Security Kit is recommended on units above 60". See Accessory Items. | | | | | | |
|  Bookcase | GCLBC02N | 14.5 x 34.5 x 37.5 | 150 | 76 | 16 | \$1089 |
| 37.5" High. 1 adjustable shelf. | | | | | | |
|  Wall Mount Memory Box | GCLMB01LN (left opening) | 6 x 21 x 35 | 85 | 55 | 4.30 | \$848 |
| | GCLMB01RN (right opening) | 6 x 21 x 35 | 85 | 55 | 4.30 | \$848 |
| 3 adjustable shelves. LEFT/RIGHT opening Tempered Glass door framed in laminate finish. Lock is standard. Installation brackets are heavy duty extruded aluminum and include a level and hardware. | | | | | | |
|  Mirror 21" Wide | GCLMR01N | 2 x 21 x 35 | 70 | 29 | 1.50 | \$679 |
| Framed in laminate finish, includes a bottom ledge. Mirror is backed in Shatterproof Safety Tape, tested for shatter resistance. Installation brackets are heavy duty extruded aluminum and include a level and hardware. | | | | | | |
|  Mirror 33" Wide | GCLMR02N | 2 x 33 x 35 | 85 | 29 | 2.12 | \$949 |
| Framed in laminate finish, includes a bottom ledge. Mirror is backed in Shatterproof Safety Tape, tested for shatter resistance. Installation brackets are heavy duty extruded aluminum and include a level and hardware. | | | | | | |
|  White Board | GCLWB01N | 2 x 21 x 35 | 85 | 20 | 1.50 | \$429 |
| Framed in laminate finish, includes a bottom ledge. Installation brackets are heavy duty extruded aluminum and include a level and hardware. | | | | | | |
|  Tackboard | GCLTB01N | 2 x 21 x 35 | 100 | 12 | 1.50 | \$463 |
| Tackable surface is Forbo linoleum in (F287) Sandcastle. Framed in laminate finish, includes a 1" bottom ledge. Installation brackets are heavy duty extruded aluminum and include a level and hardware. | | | | | | |

ACCESSORY ITEMS MODEL# DIMENSIONS FREIGHT CLASS WT/LBS. CUBIC FT. LIST PRICE

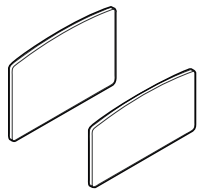

**Headboard and Footboard
Fascia Profile: Arc (AR)**

| | D x W x H | | | | |
|------------------------|-------------|----|----|------|--------------|
| GCLHF01 (SET) | 1 x 37 x 25 | 65 | 47 | 1.90 | \$848 |
| GCLHB01 (Headboard) | 1 x 37 x 25 | 85 | 26 | 1.90 | \$617 |
| GCLFB01 (Footboard) | 1 x 37 x 20 | 85 | 21 | 1.70 | \$275 |

Headboard and footboard are provided as a SET or Can be ordered individually. 1" thick High Pressure Laminate with 3mm edging.

- No predrilled holes
- No mounting brackets or hardware included
- *Verify board application and dimensions required*

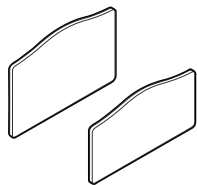

**Headboard and Footboard
Fascia Profile: Wave (WV)**

| | | | | | |
|------------------------|-------------|----|----|------|--------------|
| GCLHF02 (SET) | 1 x 37 x 25 | 65 | 47 | 1.90 | \$848 |
| GCLHB02 (Headboard) | 1 x 37 x 25 | 85 | 26 | 1.90 | \$617 |
| GCLFB02 (Footboard) | 1 x 37 x 20 | 85 | 21 | 1.70 | \$275 |

Headboard and footboard are provided as a SET or Can be ordered individually. 1" thick High Pressure Laminate with 3mm edging.

- No predrilled holes
- No mounting brackets or hardware included
- *Verify board application and dimensions required*

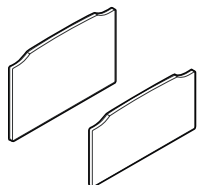

**Headboard and Footboard
Fascia Profile: Scallop (SL)**

| | | | | | |
|------------------------|-------------|----|----|------|--------------|
| GCLHF03 (SET) | 1 x 37 x 25 | 65 | 47 | 1.90 | \$848 |
| GCLHB03 (Headboard) | 1 x 37 x 25 | 85 | 26 | 1.90 | \$617 |
| GCLFB03 (Footboard) | 1 x 37 x 20 | 85 | 21 | 1.70 | \$275 |

Headboard and footboard are provided as a SET or Can be ordered individually. 1" thick High Pressure Laminate with 3mm edging.

- No predrilled holes
- No mounting brackets or hardware included
- *Verify board application and dimensions required*

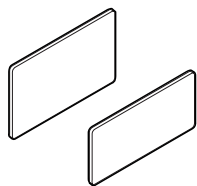

**Headboard and Footboard
Fascia Profile: Linear (LN)**

| | | | | | |
|------------------------|-------------|----|----|------|--------------|
| GCLHF04 (SET) | 1 x 37 x 25 | 65 | 47 | 1.90 | \$848 |
| GCLHB04 (Headboard) | 1 x 37 x 25 | 85 | 26 | 1.90 | \$617 |
| GCLFB04 (Footboard) | 1 x 37 x 20 | 85 | 21 | 1.70 | \$275 |

Headboard and footboard are provided as a SET or Can be ordered individually. 1" thick High Pressure Laminate with 3mm edging.

- No predrilled holes
- No mounting brackets or hardware included
- *Verify board application and dimensions required*

| ACCESSORY ITEMS | MODEL# | DIMENSIONS | FREIGHT CLASS | WT/LBS. | CUBIC FT. | LIST PRICE |
|-----------------|--------|------------|---------------|---------|-----------|------------|
|-----------------|--------|------------|---------------|---------|-----------|------------|

D x W x H

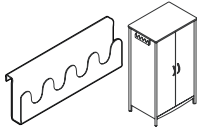

Multiple Hook

| | | | | | |
|---------|---------------|-----|---|-----|-------------|
| GCLHA01 | 2 x 13 x 4.25 | 150 | 1 | .20 | \$82 |
|---------|---------------|-----|---|-----|-------------|

Fits into ventilation opening of Wardrobes providing additional hanging of frequently worn or accessed items.
 • Standard Powder Coated Paint Finish Color: Sierra (SC).

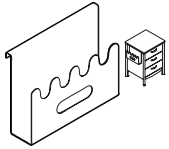

Magazine/Tissue Holder

| | | | | | |
|---------|----------------|-----|------|-----|--------------|
| GCLHA02 | 3.75 x 13 x 10 | 250 | 1.50 | .60 | \$135 |
|---------|----------------|-----|------|-----|--------------|

Fits into ventilation opening of Bedside Cabinet or Dresser providing convenient storage and hanging of frequently accessed items.
 • Standard Powder Coated Paint Finish Color: Sierra (SC).



Safety Garment Hook

| | | | | | |
|---------|----------------|-----|------|-----|-------------|
| GCLHA03 | 1 x 1.5 x 3.25 | 125 | 1.50 | .20 | \$21 |
|---------|----------------|-----|------|-----|-------------|

Garment hook provides additional hanging storage on the inside **right** and **center** wardrobe doors as standard. Engineered with the safety feature to support a maximum weight of 75 lbs.
 • Standard Powder Coated Paint Finish Color: Sierra (SC).

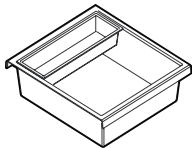

Bedside Drawer Liner and Personal Organizer

| | | | | | |
|---------|------------------|-----|---|------|--------------|
| GCLLP01 | 16.5 x 18 x 5.25 | 300 | 2 | 1.30 | \$145 |
|---------|------------------|-----|---|------|--------------|

Constructed from high impact styrene plastic. Plastic liners have been specially designed to saddle the drawer edges for a perfect fit while eliminating gaps and potential traps. Removable.
 • French Vanilla color coordinates with the drawer interiors.



Wardrobe Mirror/Hanging Hardware

| | | | | | |
|---------|----------------|----|---|-----|--------------|
| GCLWM01 | 0.25 x 11 x 29 | 60 | 5 | .05 | \$174 |
|---------|----------------|----|---|-----|--------------|

Installed on the **left** inside of the door. Backed with Shatterproof Safety Tape, tested for shatter resistance. Double mounted with both rubber lined mirror clips and heavy duty foam tape. Edges are polished.



Anti-Tip Security Kit

| | | | | | |
|---------|----|----|-----|-----|-------------|
| GCAT400 | -- | 70 | .24 | .10 | \$78 |
|---------|----|----|-----|-----|-------------|

Helps to prevent furniture from tipping over. This cabinet stabilization hardware is made from steel and galvanized steel aircraft cable. Full installation instructions are included. Recommended for all 72" high units.
 • TWO Kits are required for LWA, LWC, LWD, LWG and LWN units.



tables
cafeteria, dining, occasional + reception



| MODEL# | DIMENSIONS | FREIGHT CLASS | WT/LBS. | CUBIC FT. | LIST PRICE |
|-----------|------------|---------------|---------|-----------|------------|
| D x W x H | | | | | |

Notes:

- 1 3/4" tubular steel frame. Finishes available in Black (BLK), Platinum (PLT), Toast (TOA), Tungsten (TUN), Cappuccino (T20), Mocha (J52), and Kalua (KAL). Please specify leg finish color when placing order.
- Frame can be weighted and made with tamper proof fasteners
- Tables are 16" high
- Please specify all substitutions and options.
- 1" thick tops are available in thermally fused laminate (L) and high pressure laminate (H). Please select the appropriate model number for the finish you prefer.
- 3mm edging color coordinated with laminate finish is standard for all tops. Finish **MUST BE** specified at the time of order.
- Refer to the following lists when selecting a finish color. **MUST** Specify both a Top Color and Leg Finish when ordering.
- For custom laminate or contrasting edge, please contact your Global sales representative for special quotation.

Thermally Fused Laminate (L)

- (ACJ) Absolute Acajou
- (ASN) Asian Night
- (AWC) Avant Cherry
- (AWH) Avant Honey
- (BRC) Brushed Cobalt
- (CSJ) Constellation Java
- (DES) Dark Espresso
- (HGT) Hayden Grey
- (QTM) Quartered Mahogany
- (SKC) Shaker Cherry
- (TFW) Tiger Fruitwood
- (TMA) Tiger Mahogany
- (TMP) Tiger Maple
- (TWL) Tiger Walnut
- (WHT) White
- (WHC) White Chocolate
- (WCR) Winter Cherry

High Pressure Laminate (H)

- (W357) Avant Cherry
- (W356) Avant Honey
- (BCH) Brushed Cobalt
- (CJH) Constellation Java
- (W142) Dark Espresso
- (CMB) Clear Maple
- (EMB) Empire Mahogany
- (W313) Quartered Mahogany
- (SKB) Shaker Cherry
- (W821) Tiger Fruitwood
- (W822) Tiger Mahogany
- (W820) Tiger Maple
- (W819) Tiger Walnut
- (S645) White
- (W149) Winter Cherry

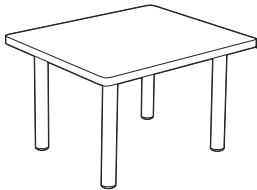

Rectangular End Table

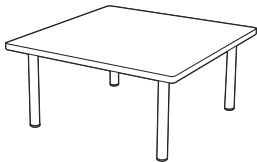

Corner Table Square

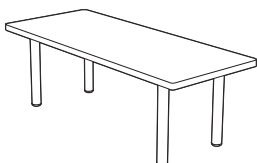

Coffee Table Rectangular

| | | | | | |
|-----------|--------------|-----|----|------|--------------|
| GC4191-LP | 22 x 26 x 16 | 100 | 25 | 3.10 | \$567 |
| GC4191-HP | 22 x 26 x 16 | 100 | 25 | 3.10 | \$650 |

- For a thermally fused laminate top (LP), specify model GC4191-LP
- For a high pressure laminate top (HP), specify model GC4191-HP.

1" thick top with coordinating 3mm edge and 1 3/4" dia. steel tubular legs

| | | | | | |
|-----------|--------------|-----|----|---|--------------|
| GC4192-LP | 34 x 34 x 16 | 125 | 46 | 6 | \$698 |
| GC4192-HP | 34 x 34 x 16 | 125 | 46 | 6 | \$836 |

- For a thermally fused laminate top (LP), specify model GC4192-LP.
- For a high pressure laminate top (HP), specify model GC4192-HP.

1" thick top with coordinating 3mm edge and 1 3/4" dia. steel tubular legs

| | | | | | |
|-----------|--------------|-----|----|------|--------------|
| GC4193-LP | 20 x 48 x 16 | 125 | 37 | 5.75 | \$662 |
| GC4193-HP | 20 x 48 x 16 | 125 | 37 | 5.75 | \$789 |

- For a thermally fused laminate top (LP), specify model GC4193-LP.
- For a high pressure laminate top (HP), specify model GC4193-HP.

1" thick top with coordinating 3mm edge and 1 3/4" dia. steel tubular legs

| MODEL# | DIMENSIONS | FREIGHT CLASS | WT/LBS. | CUBIC FT. | LIST PRICE |
|--------|------------|---------------|---------|-----------|------------|
|--------|------------|---------------|---------|-----------|------------|

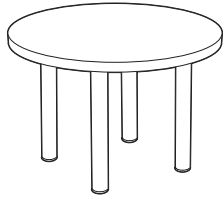

24" Round Table

| | D x W x H | | | | |
|-----------|--------------|-----|----|------|--------------|
| GC4194-LP | 24 x 24 x 16 | 125 | 25 | 3.40 | \$551 |
| GC4194-HP | 24 x 24 x 16 | 125 | 25 | 3.40 | \$602 |

- For a thermally fused laminate top (LP), specify model GC4194-LP.
- For a high pressure laminate top (HP), specify model GC4194-HP.

1" thick top with coordinating 3mm edge and 1 3/4" dia. steel tubular legs

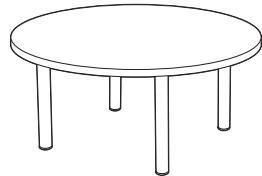

36" Round Table

| | | | | | |
|-----------|--------------|-----|----|---|--------------|
| GC4195-LP | 36 x 36 x 16 | 125 | 42 | 6 | \$673 |
| GC4195-HP | 36 x 36 x 16 | 125 | 42 | 6 | \$726 |

- For a thermally fused laminate top (LP), specify model GC4194-LP.
- For a high pressure laminate top (HP), specify model GC4194-HP.

1" thick top with coordinating 3mm edge and 1 3/4" dia. steel tubular legs

| MODEL# | DIMENSIONS D x W x H | FREIGHT CLASS | WT/LBS. | CUBIC FT. | LIST PRICE |
|--------|-------------------------|---------------|---------|-----------|------------|
|--------|-------------------------|---------------|---------|-----------|------------|

Notes - PLEASE SPECIFY all substitutions and options

- Offers a solution to users with limited mobility.
- Height Adjustable Tablet surface adjusts upward offering users better support while eating.
- Adjustable 1.5" range Black plastic glides are standard. EXCEPT Tungsten (TUN) which has Tungsten glides.
- Heavy duty tapered steel leg finishes available in Black (**BLK**), Platinum (**PLT**), Storm Grey (**SOG**), Toast (**TOA**) and Tungsten (**TUN**). Finish MUST BE specified at the time of order.
- Shipped RTA (ready to assemble).
- Optional leg on caster available if required.
- 3mm edging color coordinated with laminate finish is standard for all tops. Finish MUST BE specified at the time of order.
- 1" thick tops are available in thermally fused laminate (LP) and high pressure laminate (HP). Please select the appropriate model number for the finish you prefer.
- Refer to the following lists when selecting a finish color. MUST Specify both a Top Color and Leg Finish when ordering.
- For custom laminate or contrasting edge, please contact your Global sales representative for special quotation.

Thermally Fused Laminate (L)

- (ACJ) Absolute Acajou
- (ASN) Asian Night
- (AWC) Avant Cherry
- (AWH) Avant Honey
- (BRC) Brushed Cobalt
- (CSJ) Constellation Java
- (DES) Dark Espresso
- (HGT) Hayden Grey
- (QTM) Quartered Mahogany
- (SKC) Shaker Cherry
- (TFW) Tiger Fruitwood
- (TMA) Tiger Mahogany
- (TMP) Tiger Maple
- (TWL) Tiger Walnut
- (WHT) White
- (WHC) White Chocolate
- (WCR) Winter Cherry

High Pressure Laminate (H)

- (W357) Avant Cherry
- (W356) Avant Honey
- (BCH) Brushed Cobalt
- (CJH) Constellation Java
- (W142) Dark Espresso
- (CMB) Clear Maple
- (EMB) Empire Mahogany
- (W313) Quartered Mahogany
- (SKB) Shaker Cherry
- (W821) Tiger Fruitwood
- (W822) Tiger Mahogany
- (W820) Tiger Maple
- (W819) Tiger Walnut
- (S645) White
- (W149) Winter Cherry

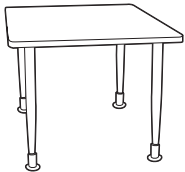

Table Top with Legs

| | | | | | |
|---------|--------------|----|----|------|---------------|
| GCHAMTL | 42 x 36 x 29 | 85 | 59 | 4.10 | \$1386 |
| GCHAMTH | 42 x 36 x 29 | 85 | 59 | 4.10 | \$1748 |

- For a thermally fused top (LP), specify model GCHAMTL.
- For a high pressure laminate top (HP), specify model GCHAMTH.

Allows for 2 Dual Arm Tablets to be installed on the 36" wide ends and 2 Fixed Arm Tablets on the 42" sides.

- 2 cartons



E-Z Lift Dual Arm Tablet

| | | | | | |
|----------|-------------|-----|----|------|---------------|
| GC3-DATL | 13 x 36 x 8 | 125 | 31 | 4.90 | \$1192 |
| GC3-DATH | 13 x 36 x 8 | 125 | 31 | 4.90 | \$1460 |

- For a thermally fused top (LP), specify model GC3-DATL.
- For a high pressure laminate top (HP), specify model GC3-DATH.

Adjust up or down by the use of a single paddle actuator. Tablet remains level during adjustment and has a positive locking, smooth counterbalanced operation through the use of a gas cylinder. Tablet range of adjustment is 21"H to 36"H from the floor. Guard at the back prevents items from falling.

- Allowance between arms is 22.5" for use with wheelchairs.
- Fits pre-drilled inserts on 42" table sides ONLY. Hardware for attaching to table top is included.
- Mechanism and tablet bracket are available in Black only.



Fixed Height Tablet

| | | | | | |
|-----------|-------------|----|----|-----|--------------|
| GC3-1336L | 13 x 36 x 1 | 70 | 15 | .90 | \$509 |
| GC3-1336H | 13 x 36 x 1 | 70 | 15 | .90 | \$753 |

- For a thermally fused top (LP), specify model GC3-1336L.
- For a high pressure laminate top (HP), specify model GC3-1336H.

Fixed height tablet surface with connecting bracket. Heavy Duty steel Mounting Bracket is available in Black only.

- Hardware for attaching to table top is included

| MODEL# | DIMENSIONS | FREIGHT CLASS | WT/LBS. | CUBIC FT. | LIST PRICE |
|--------|------------|---------------|---------|-----------|------------|
|--------|------------|---------------|---------|-----------|------------|

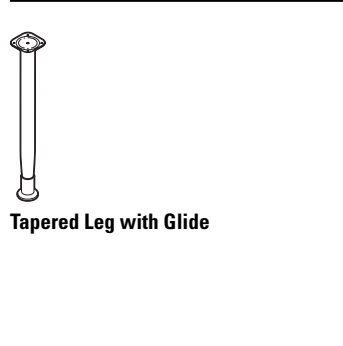

| | D x W x H | | | | |
|--------|------------------|-----|-------|------|--------------|
| LLL291 | 5.25 x 5.25 x 28 | 100 | 4.80 | .52 | \$112 |
| LLL294 | 5.25 x 5.25 x 28 | 100 | 18.40 | 2.10 | \$435 |

- Hardware for assembly is included.

Support leg with glide. 1.5" glide range adjustment.

- 1 per carton for LLL291.
- 4 per carton for LLL294.
- Available in Black (**BLK**), Storm Grey (**SOG**), Platinum (**PLT**), Toast (**TOA**), and Tungsten (**TUN**). Finish MUST BE specified at the time of order.

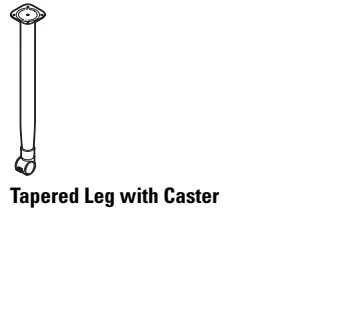

| | | | | | |
|--------|------------------|-----|-------|------|--------------|
| LCL291 | 5.25 x 5.25 x 28 | 100 | 4.80 | .52 | \$112 |
| LCL294 | 5.25 x 5.25 x 28 | 100 | 18.40 | 2.10 | \$435 |

- Hardware for assembly is included.

Support leg with lockable caster.

- 1 per carton for LCL291.
- 4 per carton for LCL294.
- Available in Black (**BLK**), Storm Grey (**SOG**), Platinum (**PLT**), Toast (**TOA**), and Tungsten (**TUN**). Finish MUST BE specified at the time of order.

PACKAGES

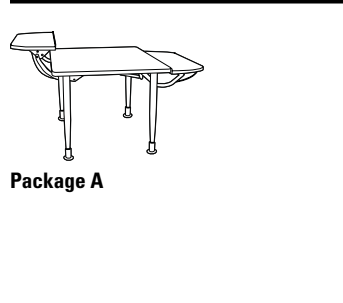

| | | | | | |
|---------|--------------|-----|--------|-------|---------------|
| GCHATAL | 64 x 42 x 29 | 150 | 120.50 | 20.78 | \$3707 |
| GCHATAH | 64 x 42 x 29 | 150 | 120.50 | 20.78 | \$4593 |

- For a thermally fused top (LP), specify model GCHATAL
- For a high pressure laminate top (HP), specify model GCHATAH.

- Table Top
- Metal inserts pre-drilled for Tablets
- 2 Dual Arm Tablets
- 4 cartons.
- 4 Tapered Legs on Glides
- All Hardware

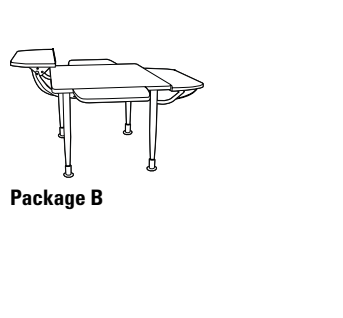

| | | | | | |
|---------|--------------|-----|--------|-------|---------------|
| GCHATBL | 68 x 64 x 29 | 100 | 135.50 | 14.40 | \$4629 |
| GCHATBH | 68 x 64 x 29 | 100 | 135.50 | 14.40 | \$5998 |

- For a thermally fused top (LP), specify model GCHATBL
- For a high pressure laminate top (HP), specify model GCHATBH.

- Table Top
- Metal inserts pre-drilled for Tablets
- 2 Dual Arm Tablets
- 6 cartons.
- 2 Fixed Tablets
- 4 Tapered Legs on Glides
- All Hardware

| NOTES | MODEL# | DIMENSIONS | FREIGHT CLASS | WT/LBS. | CUBIC FT. | LIST PRICE |
|-----------|--------|------------|---------------|---------|-----------|------------|
| D x W x H | | | | | | |

PLEASE SPECIFY all substitutions and options

- Attractive top design offers an inward curve at each corner allowing comfortable access if assistance with eating is required.
- Adjustable 1.5" range Black plastic glides are standard. EXCEPT Tungsten (TUN) which has Tungsten glides.
- Heavy duty tapered steel legs available in Black (**BLK**), Platinum (**PLT**), Toast (**TOA**), Storm Grey (**SOG**) and Tungsten (**TUN**). Please specify leg finish color when placing order. Cappuccino (**T20**), Mocha (**J52**), and Kalua (**KAL**) are also available by special request.
- Shipped RTA (ready to assemble).
- Optional leg on caster available if required.
- 3mm edging color coordinated with laminate finish is standard for all tops. Finish MUST BE specified at the time of order.
- 1" thick tops are available in thermally fused laminate (L) and high pressure laminate (H). Please select the appropriate model number for the finish you prefer.
- Refer to the following lists when selecting a finish color. MUST Specify both a Top Color and Leg Finish when ordering.
- For custom laminate or contrasting edge, please contact your Global sales representative for special quotation.

Thermally Fused Laminate (L)

- (ACJ) Absolute Acajou
- (ASN) Asian Night
- (AWC) Avant Cherry
- (AWH) Avant Honey
- (BRC) Brushed Cobalt
- (CSJ) Constellation Java
- (DES) Dark Espresso
- (HGT) Hayden Grey
- (QTM) Quartered Mahogany
- (SKC) Shaker Cherry
- (TFW) Tiger Fruitwood
- (TMA) Tiger Mahogany
- (TMP) Tiger Maple
- (TWL) Tiger Walnut
- (WHT) White
- (WHC) White Chocolate
- (WCR) Winter Cherry

High Pressure Laminate (H)

- (W357) Avant Cherry
- (W356) Avant Honey
- (BCH) Brushed Cobalt
- (CJH) Constellation Java
- (W142) Dark Espresso
- (CMB) Clear Maple
- (EMB) Empire Mahogany
- (W313) Quartered Mahogany
- (SKB) Shaker Cherry
- (W821) Tiger Fruitwood
- (W822) Tiger Mahogany
- (W820) Tiger Maple
- (W819) Tiger Walnut
- (S645) White
- (W149) Winter Cherry



Floral Dining Room Table - 42"



Floral Dining Room Table - 48"

| | | | | | |
|---------|--------------|----|----|------|---------------|
| GCF-42L | 42 x 42 x 29 | 70 | 79 | 4.14 | \$1289 |
| GCF-42H | 42 x 42 x 29 | 70 | 79 | 4.14 | \$1619 |

- For a thermally fused top (L), specify model GCF-42L.
- For a high pressure laminate top (H), specify model GCF-42H.

42" x 42" thermally fused laminate top. Four legs.
 • Additional leg heights are available. Special quote is required.
 • 2 cartons

| | | | | | |
|---------|--------------|----|----|------|---------------|
| GCF-48L | 48 x 48 x 29 | 70 | 98 | 4.70 | \$1348 |
| GCF-48H | 48 x 48 x 29 | 70 | 98 | 4.70 | \$1790 |

- For a thermally fused top (L), specify model GCF-48L.
- For a high pressure laminate top (H), specify model GCF-48H.

48" x 48" thermally fused laminate top. Four legs.
 • Additional leg heights are available. Special quote is required.
 • 2 cartons

| NOTES | MODEL# | DIMENSIONS D x W x H | FREIGHT CLASS | WT/LBS. | CUBIC FT. | LIST PRICE |
|-------|--------|-------------------------|---------------|---------|-----------|------------|
|-------|--------|-------------------------|---------------|---------|-----------|------------|

- Elliptical metal tube frame available in Black (**BLK**), Platinum (**PLT**), Toast (**TOA**), Tungsten (**TUN**), Cappuccino (**T20**), Mocha (**J52**), and Kalua (**KAL**). Please specify leg finish color when placing order.
- Freestanding tables coordinate with GC-Belong and Strand seating series. Table Bridges can be mounted only to GC-Belong ganging seating or bench units. Table Bridges do not have legs. All bridge models can be ganged to seat units with link. Please refer to the seating section for more information on Ganging.
- Tables are 16" high
- Please specify all substitutions and options
- 1" thick tops are available in thermally fused laminate (L) and high pressure laminate (H). Please select the appropriate model number for the finish you prefer.
- 3mm edging color coordinated with laminate finish is standard for all tops. Finish **MUST BE** specified at the time of order.
- Refer to the following lists when selecting a finish color. **MUST** Specify both a Top Color and Leg Finish when ordering.
- For custom laminate or contrasting edge, please contact your Global sales representative for special quotation.

Thermally Fused Laminate (L)

- (ACJ) Absolute Acajou
- (ASN) Asian Night
- (AWC) Avant Cherry
- (AWH) Avant Honey
- (BRC) Brushed Cobalt
- (CSJ) Constellation Java
- (DES) Dark Espresso
- (HGT) Hayden Grey
- (QTM) Quartered Mahogany
- (SKC) Shaker Cherry
- (TFW) Tiger Fruitwood
- (TMA) Tiger Mahogany
- (TMP) Tiger Maple
- (TWL) Tiger Walnut
- (WHT) White
- (WHC) White Chocolate
- (WCR) Winter Cherry

High Pressure Laminate (H)

- (W357) Avant Cherry
- (W356) Avant Honey
- (BCH) Brushed Cobalt
- (CJH) Constellation Java
- (W142) Dark Espresso
- (CMB) Clear Maple
- (EMB) Empire Mahogany
- (W313) Quartered Mahogany
- (SKB) Shaker Cherry
- (W821) Tiger Fruitwood
- (W822) Tiger Mahogany
- (W820) Tiger Maple
- (W819) Tiger Walnut
- (S645) White
- (W149) Winter Cherry

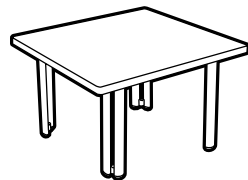

Rectangular End Table

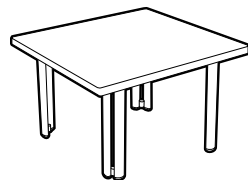

Square End Table



Square End Table

| | | | | | |
|-----------|--------------|-----|----|------|--------------|
| GC4281-LP | 18 x 22 x 16 | 100 | 30 | 3.40 | \$621 |
| GC4281-HP | 18 x 22 x 16 | 100 | 30 | 3.40 | \$701 |

- For a thermally fused laminate top (LP), specify model GC4281-LP.
- For a high pressure laminate top (HP), specify model GC4281-HP.

Coordinating 3mm edge. Oval steel tube legs

| | | | | | |
|-----------|--------------|-----|----|------|--------------|
| GC4288-LP | 23 x 23 x 16 | 100 | 31 | 3.40 | \$709 |
| GC4288-HP | 23 x 23 x 16 | 100 | 31 | 3.40 | \$787 |

- For a thermally fused laminate top (LP), specify model GC4288-LP.
- For a high pressure laminate top (HP), specify model GC4288-HP.

Coordinating 3mm edge. Oval steel tube legs.

| | | | | | |
|-----------|--------------|-----|----|---|--------------|
| GC4282-LP | 30 x 30 x 16 | 150 | 34 | 6 | \$796 |
| GC4282-HP | 30 x 30 x 16 | 150 | 34 | 6 | \$888 |

- For a thermally fused laminate top (LP), specify model GC4282-LP.
- For a high pressure laminate top (HP), specify model GC4282-HP.

Coordinating 3mm edge. Oval steel tube legs.

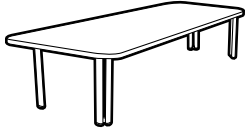

Rectangular Coffee Table



Square Coffee Table

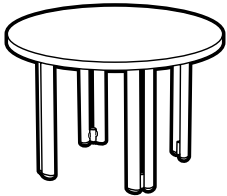

Round Coffee Table - 24" Diameter

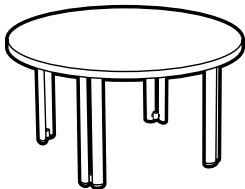

Round Coffee Table - 30" Diameter

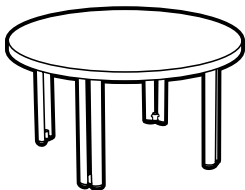

Round Coffee Table 36" Diameter

| MODEL# | DIMENSIONS | FREIGHT CLASS | WT/LBS. | CUBIC FT. | LIST PRICE |
|--------|------------|---------------|---------|-----------|------------|
|--------|------------|---------------|---------|-----------|------------|

D x W x H

| | | | | | |
|-----------|--------------|-----|----|---|--------------|
| GC4283-LP | 22 x 54 x 16 | 125 | 37 | 6 | \$801 |
| GC4283-HP | 22 x 54 x 16 | 125 | 37 | 6 | \$934 |

- For a thermally fused laminate top (LP), specify model GC4283-LP.
- For a high pressure laminate top (HP), specify model GC4283-HP.

Coordinating 3mm edge. Oval steel tube legs

| | | | | | |
|-----------|--------------|-----|----|---|--------------|
| GC4284-LP | 36 x 36 x 16 | 125 | 37 | 6 | \$836 |
| GC4284-HP | 36 x 36 x 16 | 125 | 37 | 6 | \$934 |

- For a thermally fused laminate top (LP), specify model GC4284-LP.
- For a high pressure laminate top (HP), specify model GC4284-HP.

Coordinating 3mm edge. Oval steel tube legs

| | | | | | |
|-----------|--------------|-----|----|------|--------------|
| GC4285-LP | 24 x 24 x 16 | 100 | 33 | 3.40 | \$779 |
| GC4285-HP | 24 x 24 x 16 | 100 | 33 | 3.40 | \$842 |

- For a thermally fused laminate top (LP), specify model GC4285-LP.
- For a high pressure laminate top (HP), specify model GC4285-HP.

Coordinating 3mm edge. Oval steel tube legs

| | | | | | |
|-----------|--------------|-----|----|---|--------------|
| GC4286-LP | 30 x 30 x 16 | 150 | 34 | 6 | \$783 |
| GC4286-HP | 30 x 30 x 16 | 150 | 34 | 6 | \$842 |

- For a thermally fused laminate top (LP), specify model GC4286-LP.
- For a high pressure laminate top (HP), specify model GC4286-HP.

Coordinating 3mm edge. Oval steel tube legs

| | | | | | |
|-----------|--------------|-----|----|---|--------------|
| GC4287-LP | 36 x 36 x 16 | 125 | 37 | 6 | \$884 |
| GC4287-HP | 36 x 36 x 16 | 125 | 37 | 6 | \$983 |

- For a thermally fused laminate top (LP), specify model GC4287-LP.
- For a high pressure laminate top (HP), specify model GC4287-HP.

Coordinating 3mm edge. Oval steel tube legs

| TABLE BRIDGES | MODEL# | DIMENSIONS | FREIGHT CLASS | WT/LBS. | CUBIC FT. | LIST PRICE |
|---------------|--------|------------|---------------|---------|-----------|------------|
|---------------|--------|------------|---------------|---------|-----------|------------|

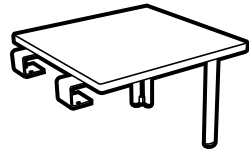

End Table Bridge, Not Freestanding

| | D x W x H | | | | | |
|-----------|--------------|-----|----|------|--|--------------|
| GC4274-LP | 23 x 23 x 16 | 125 | 25 | 3.40 | | \$510 |
| GC4274-HP | 23 x 23 x 16 | 125 | 25 | 3.40 | | \$546 |

- For a thermally fused laminate top (LP), specify model GC4274-LP.
- For a high pressure laminate top (HP), specify model GC4274-HP.

1 end suspends to a seating unit via linking brackets. Coordinating 3mm edge. Oval steel tube legs Reversible.

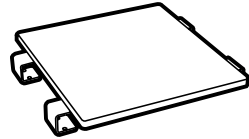

Square Table Top, Not Freestanding

| | | | | | | |
|-----------|-------------|-----|----|------|--|--------------|
| GC4275-LP | 23 x 23 x 1 | 150 | 18 | 3.40 | | \$355 |
| GC4275-HP | 23 x 23 x 1 | 150 | 18 | 3.40 | | \$401 |

- For a thermally fused laminate top (LP), specify model GC4275-LP.
- For a high pressure laminate top (HP), specify model GC4275-HP.

Suspends between two seating units via linking brackets. Coordinating 3mm edge No legs. Reversible.



End Corner Table Bridge Not Freestanding

| | | | | | | |
|-----------|--------------|-----|----|---|--|--------------|
| GC4277-LP | 35 x 35 x 16 | 125 | 45 | 6 | | \$567 |
| GC4277-HP | 35 x 35 x 16 | 125 | 45 | 6 | | \$650 |

- For a thermally fused laminate top (LP), specify model GC4277-LP.
- For a high pressure laminate top (HP), specify model GC4277-HP.

Suspends between two seating units via linking brackets. Coordinating 3mm edge. Oval steel tube legs Can be used for right or left corner.



End Corner Curve Table Bridge Not Freestanding

| | | | | | | |
|-----------|--------------|-----|----|---|--|--------------|
| GC4278-LP | 35 x 35 x 16 | 125 | 45 | 6 | | \$567 |
| GC4278-HP | 35 x 35 x 16 | 125 | 45 | 6 | | \$650 |

- For a thermally fused laminate top (LP), specify model GC4278-LP.
- For a high pressure laminate top (HP), specify model GC4278-HP.

Suspends between two seating units via linking brackets. Coordinating 3mm edge. Oval steel tube legs Can be used for right or left corner.

| NOTES & SPECIFICATIONS | MODEL# | DIMENSIONS | FREIGHT CLASS | WT/LBS. | CUBIC FT. | LIST PRICE |
|------------------------|--------|------------|---------------|---------|-----------|------------|
| D x W x H | | | | | | |

- Tables can be mounted to seating or bench units to create a unique configuration.
- Square and rectangular shaped occasional tables offer the added convenience of a magazine rack.
- All tables are shipped Knock Down (KD), complete with the bolts and the plates attached to the legs.
- A Fully Assembled Shipping option is available. Please contact your GLOBALcare Sales Representative for a special quotation.
- Tops are 1" thick and available in thermally fused laminate (LP) or high pressure laminate. Please select the appropriate model number for the finish you prefer.
- 3mm edging color coordinated with laminate finish is standard for all tops. Finish **MUST BE** specified at the time of order.
- For custom laminate or contrasting edge, please contact your Global sales representative for special quotation.

Thermally Fused Laminate (L)

- (ACJ) Absolute Acajou
- (ASN) Asian Night
- (AWC) Avant Cherry
- (AWH) Avant Honey
- (BRC) Brushed Cobalt
- (CSJ) Constellation Java
- (DES) Dark Espresso
- (HGT) Hayden Grey
- (QTM) Quartered Mahogany
- (SKC) Shaker Cherry
- (TFW) Tiger Fruitwood
- (TMA) Tiger Mahogany
- (TMP) Tiger Maple
- (TWL) Tiger Walnut
- (WHT) White
- (WHC) White Chocolate
- (WCR) Winter Cherry

High Pressure Laminate (H)

- (W357) Avant Cherry
- (W356) Avant Honey
- (BCH) Brushed Cobalt
- (CJH) Constellation Java
- (W142) Dark Espresso
- (W313) Quartered Mahogany
- (SKB) Shaker Cherry
- (W821) Tiger Fruitwood
- (W822) Tiger Mahogany
- (W820) Tiger Maple
- (W819) Tiger Walnut
- (S645) White
- (W149) Winter Cherry
- (CMB) Clear Maple
- (EMB) Empire Mahogany



ALUMINUM Frame Leg Insert Options

- Aluminum leg frames available in Platinum (PLT), Toast (TOA), Tungsten (TUN), Cappuccino (T20), Mocha (J52), and Kalua (KAL). Please Specify.
- **Leg Cap:** The **Half-Leg** option is available in the following finishes:
 - **Standard** - Urethane Ribbed Leg Insert - Available in Black (BK) Only.
 - **Aluminum** - Ribbed Leg Inserts are available in - Silver (AU), Champagne (CP) and Bronze (LB).
Non-Ribbed Leg Inserts are available in - Silver (PS), Platinum (PLT), Toast (TOA), Cappuccino (T20), Mocha (J52), and Kalua (KAL).
See individual models for specific upcharge. MUST Specify Ribbed or Non-Ribbed when ordering.
 - **Wood** - Available in the following finishes: **Add \$120.00.**
Absolute (AAM), Brandy Peppercorn (BPM), Charcoal Java (CJM), Cherry (ACM), Cherry Latte (CLM), Cocoa Vanilla (CVM), Empire Mahogany (EMM), English Oak (EOM), Espresso Cafe (ECM), Fruitwood (TFM), Gray (HGM), Harvest Oak (HOM), Honey (AHM), Jet Onyx (JOM), Light Honey (LHM), Mahogany (TMM), Maple (AVM), Medium Walnut (MWM), Night (ASM), Sandy Beach (SBM), Shaker Cherry (SKM), Silver Oak (SOM), Walnut (TWM), White (WHM), WC Cream (WTM) and Winter Cherry (WCM).
Maple faced veneers and solids are used for all finishes.

LEG CAPS

Standard

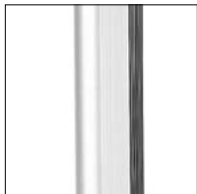

Black (ribbed), PVC front leg cap

Option



Aluminum (ribbed or non-ribbed - Silver only), front leg cap

Option

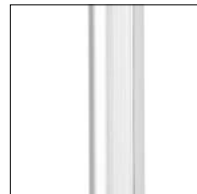

Wood front leg cap

Suggested Applications

- Waiting Areas
- Lobbies

TABLES

INTERLOCK I

| MODEL# | DIMENSIONS | FREIGHT CLASS | WT/LBS. | CUBIC FT. | LIST PRICE |
|--------|------------|---------------|---------|-----------|------------|
|--------|------------|---------------|---------|-----------|------------|

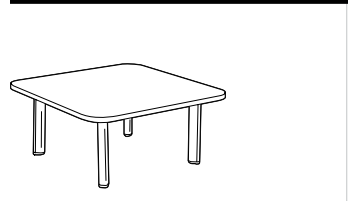

**Square End Table - Aluminum Legs
23" Square**

| D x W x H | | | | | |
|------------|--------------|-----|----|------|--------------|
| GC4103S | 23 x 23 x 16 | 125 | 25 | 3.40 | \$823 |
| GC4103S-LP | 23 x 23 x 16 | 125 | 23 | 3.40 | \$792 |

- For a thermally fused top (LP), specify model GC4103S-LP.
- For a high pressure laminate top, specify model GC4103S.

Coordinating 3 mm edge.

- Leg Cap Black Urethane: No Upcharge
- Leg Cap Option - Wood: **Add 120.00**
- Leg Cap Option - Aluminum: **Add 189.00**

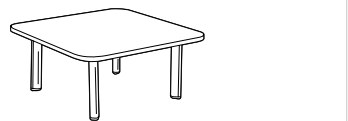

**Square End Table - Aluminum Legs
21" Square**

| | | | | | |
|------------|--------------|-----|----|------|--------------|
| GC4104S | 21 x 21 x 16 | 125 | 24 | 3.40 | \$823 |
| GC4104S-LP | 21 x 21 x 16 | 125 | 22 | 3.40 | \$792 |

- For a thermally fused top (LP), specify model GC4104S-LP.
- For a high pressure laminate top, specify model GC4104S.

Coordinating 3 mm edge.

- Leg Cap Black Urethane: No Upcharge
- Leg Cap Option - Wood: **Add 120.00**
- Leg Cap Option - Aluminum: **Add 189.00**

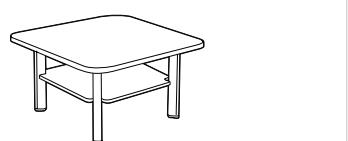

**Square End Table w/Magazine Shelf
Aluminum Legs, 23" Square**

| | | | | | |
|--------------|--------------|------|----|------|--------------|
| GC4103SMR | 23 x 23 x 16 | 92.5 | 34 | 3.40 | \$991 |
| GC4103SMR-LP | 23 x 23 x 16 | 100 | 32 | 3.40 | \$975 |

- For a thermally fused top (LP), specify model GC4103SMR-LP.
- For a high pressure laminate top, specify model GC4103SMR.

Coordinating 3 mm edge.

- Leg Cap Black Urethane: No Upcharge
- Leg Cap Option - Wood: **Add 120.00**
- Leg Cap Option - Aluminum: **Add 189.00**

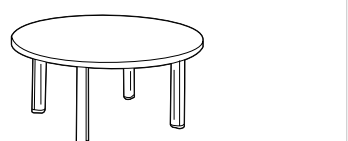

Round Coffee Table - Aluminum Legs

| | | | | | |
|------------|--------------|-----|----|---|--------------|
| GC4108C | 36 x 36 x 16 | 125 | 37 | 6 | \$831 |
| GC4108C-LP | 36 x 36 x 16 | 150 | 34 | 6 | \$770 |

- For a thermally fused top (LP), specify model GC4108C-LP.
- For a high pressure laminate top, specify model GC4108C.

Coordinating 3 mm edge.

- Leg Cap Black Urethane: No Upcharge
- Leg Cap Option - Wood: **Add 120.00**
- Leg Cap Option - Aluminum: **Add 189.00**

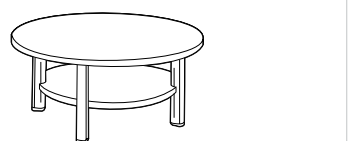

**Round Coffee Table w/Magazine Shelf
Aluminum Legs**

| | | | | | |
|--------------|--------------|-----|----|---|---------------|
| GC4108CMR | 36 x 36 x 16 | 100 | 57 | 6 | \$1292 |
| GC4108CMR-LP | 36 x 36 x 16 | 100 | 54 | 6 | \$1168 |

- For a thermally fused top (LP), specify model GC4108CMR-LP.
- For a high pressure laminate top, specify model GC4108CMR.

Coordinating 3 mm edge.

- Leg Cap Black Urethane: No Upcharge
- Leg Cap Option - Wood: **Add 120.00**
- Leg Cap Option - Aluminum: **Add 189.00**

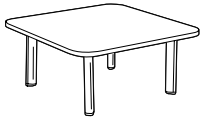

Square Coffee Table - Aluminum Legs

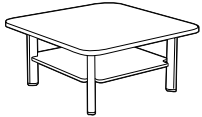

Square Coffee Table w/Magazine Shelf Aluminum Legs

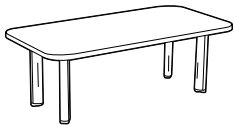

Rectangular Coffee Table Aluminum Legs

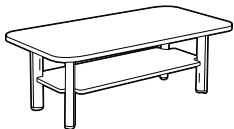

Rectangular Coffee Table w/Magazine Shelf - Aluminum Legs

| MODEL# | DIMENSIONS D x W x H | FREIGHT CLASS | WT/LBS. | CUBIC FT. | LIST PRICE |
|--------|-------------------------|---------------|---------|-----------|------------|
|--------|-------------------------|---------------|---------|-----------|------------|

| | | | | | |
|------------|--------------|-----|----|---|--------------|
| GC4108S | 36 x 36 x 16 | 125 | 43 | 6 | \$831 |
| GC4108S-LP | 36 x 36 x 16 | 125 | 40 | 6 | \$770 |

- For a thermally fused top (LP), specify model GC4108S-LP.
- For a high pressure laminate top, specify model GC4108S.

- Coordinating 3 mm edge.
- Leg Cap Black Urethane: No Upcharge
 - Leg Cap Option - Wood: **Add 120.00**
 - Leg Cap Option - Aluminum: **Add 189.00**

| | | | | | |
|--------------|--------------|------|----|---|---------------|
| GC4108SMR | 36 x 36 x 16 | 92.5 | 63 | 6 | \$1292 |
| GC4108SMR-LP | 36 x 36 x 16 | 92.5 | 60 | 6 | \$1168 |

- For a thermally fused top (LP), specify model GC4108SMR-LP.
- For a high pressure laminate top, specify model GC4108SMR.

- Coordinating 3 mm edge.
- Leg Cap Black Urethane: No Upcharge
 - Leg Cap Option - Wood: **Add 120.00**
 - Leg Cap Option - Aluminum: **Add 189.00**

| | | | | | |
|------------|--------------|-----|----|------|--------------|
| GC4109R | 24 x 48 x 16 | 125 | 39 | 5.75 | \$831 |
| GC4109R-LP | 24 x 48 x 16 | 125 | 36 | 5.75 | \$782 |





- For a thermally fused top (LP), specify model GC4109R-LP.
- For a high pressure laminate top, specify model GC4109R.

- Coordinating 3 mm edge.
- Leg Cap Black Urethane: No Upcharge
 - Leg Cap Option - Wood: **Add 120.00**
 - Leg Cap Option - Aluminum: **Add 189.00**

| | | | | | |
|--------------|--------------|-----|----|------|---------------|
| GC4109RMR | 24 x 48 x 16 | 100 | 53 | 5.75 | \$1292 |
| GC4109RMR-LP | 24 x 48 x 16 | 100 | 50 | 5.75 | \$1222 |

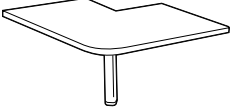
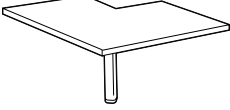
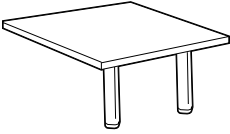
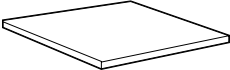
- For a thermally fused top (LP), specify model GC4109RMR-LP.
- For a high pressure laminate top, specify model GC4109RMR.

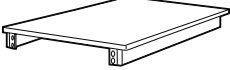
- Coordinating 3 mm edge.
- Leg Cap Black Urethane: No Upcharge
 - Leg Cap Option - Wood: **Add 120.00**
 - Leg Cap Option - Aluminum: **Add 189.00**

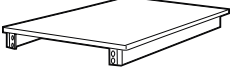
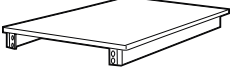
| TABLE COMPONENT PARTS | MODEL# | DIMENSIONS | FREIGHT CLASS | WT./LBS. | CUBIC FT. | LIST PRICE |
|---|---|--------------|---------------|----------|-----------|--------------|
|  <p>90° Corner Table - Aluminum Leg, Radius</p> | D x W x H | | | | | |
| | GC4100RC | 35 x 35 x 16 | 125 | 45 | 6 | \$746 |
|  <p>90° Corner Table - Aluminum Leg, Square</p> | GC4100RC-LP | 35 x 35 x 16 | 125 | 45 | 6 | \$684 |
| | <ul style="list-style-type: none"> • For a thermally fused top (LP), specify model GC4100RC-LP. • For a high pressure laminate top, specify model GC4100RC. <p>Coordinating 3 mm edge. Mounting hardware for all 4 sides is included. Allows for knee space when specifying chairs in a corner position. (Must be connected to full height or lower half frame unit.)</p> <ul style="list-style-type: none"> • Leg Cap Black Urethane: No Upcharge • Leg Cap Option - Wood: Add \$33.00 • Leg Cap Option - Aluminum: Add \$51.00 | | | | | |
|  <p>End Run Table - Aluminum Legs</p> | GC4100SC | 35 x 35 x 16 | 125 | 45 | 6 | \$746 |
| | GC4100SC-LP | 35 x 35 x 16 | 125 | 45 | 6 | \$684 |
|  <p>Square Table Top</p> | <ul style="list-style-type: none"> • For a thermally fused top (LP), specify model GC4100SC-LP. • For a high pressure laminate top, specify model GC4100SC. <p>Coordinating 3 mm edge. Mounting hardware for all 4 sides is included. Allows for knee space when specifying chairs in a corner position. (Must be connected to full height or lower half frame unit.)</p> <ul style="list-style-type: none"> • Leg Cap Black Urethane: No Upcharge • Leg Cap Option - Wood: Add \$33.00 • Leg Cap Option - Aluminum: Add \$51.00 | | | | | |
| | GC4100SE | 23 x 23 x 16 | 150 | 17 | 3.40 | \$588 |
|  <p>Square Table Top</p> | GC4100SE-LP | 23 x 23 x 16 | 150 | 17 | 3.40 | \$582 |
| | <ul style="list-style-type: none"> • For a thermally fused top (LP), specify model GC4100SE-LP. • For a high pressure laminate top, specify model GC4100SE. <p>Coordinating 3 mm edge. Mounting hardware for all 4 sides is included. (Must be connected to full height or lower half frame unit.)</p> <ul style="list-style-type: none"> • Leg Cap Black Urethane: No Upcharge • Leg Cap Option - Wood: Add \$61.00 • Leg Cap Option - Aluminum: Add \$97.00 | | | | | |
|  <p>Square Table Top with Skirt</p> | GC4100SET | 23 x 23 x 1 | 150 | 15 | 3.40 | \$377 |
| | GC4100SET-LP | 23 x 23 x 1 | 150 | 15 | 3.40 | \$353 |
|  <p>Square Table Top</p> | <ul style="list-style-type: none"> • For a thermally fused top (LP), specify model GC4100SET-LP. • For a high pressure laminate top, specify model GC4100SET. <p>Coordinating 3 mm edge. Mounting hardware for all 4 sides is included. (Must be connected to full height or lower half frame unit on each side.)</p> | | | | | |
| | GC4104ST | 21 x 21 x 1 | 150 | 14 | 3.40 | \$377 |
|  <p>Square Table Top</p> | GC4104ST-LP | 21 x 21 x 1 | 150 | 14 | 3.40 | \$353 |
| | <ul style="list-style-type: none"> • For a thermally fused top (LP), specify model GC4104ST-LP. • For a high pressure laminate top, specify model GC4104ST. <p>Replaces seat position within one piece frame. Coordinating 3 mm edge. Mounting hardware for all 4 sides is included.</p> | | | | | |
|  <p>Square Table Top with Skirt</p> | GC4104WST | 21 x 21 x 1 | 150 | 18 | 3.40 | \$453 |
| | GC4104WST-LP | 21 x 21 x 1 | 150 | 18 | 3.40 | \$430 |
|  <p>Square Table Top with Skirt</p> | <ul style="list-style-type: none"> • For a thermally fused top (LP), specify model GC4104WST-LP. • For a high pressure laminate top, specify model GC4104WST. <p>Replaces seat position within one piece frame. Coordinating 3 mm edge. Mounting hardware for all 4 sides is included.</p> | | | | | |

| TABLE COMPONENT PARTS | MODEL# | DIMENSIONS | FREIGHT CLASS | WT/LBS. | CUBIC FT. | LIST PRICE |
|-----------------------|--------|------------|---------------|---------|-----------|------------|
|-----------------------|--------|------------|---------------|---------|-----------|------------|

D x W x H

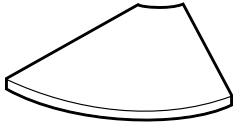

45° Table Top

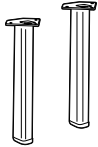

Half Leg - Aluminum

| | | | | | |
|-------------|-------------|-----|----|------|--------------|
| GC4134AT | 23 x 24 x 1 | 250 | 12 | 3.40 | \$399 |
| GC4134AT-LP | 23 x 24 x 1 | 250 | 12 | 3.40 | \$393 |

- For a thermally fused top (LP), specify model GC4134AT-LP.
- For a high pressure laminate top, specify model GC4134AT.

Coordinating 3 mm edge. Mounting hardware for all 4 sides is included. (Must be connected to full height or lower half frame unit on both sides of the top.) Can not be suspended between 2 frames with no lower leg frame.

| | | | | | |
|----------|------------|------|------|-----|--------------|
| GC4100SL | 4 x 4 x 15 | 92.5 | 3.50 | .30 | \$127 |
|----------|------------|------|------|-----|--------------|

For Tables: Aluminum leg with Black front half leg cap. Mounting plate and hardware. Per unit.

- Leg Cap Standard - Urethane: No Upcharge
- Leg Cap Option - Wood: Add 31.00.
- Leg Cap Option - Aluminum: Add 48.00.

| NOTES | MODEL# | DIMENSIONS D x W x H | FREIGHT CLASS | WT/LBS. | CUBIC FT. | LIST PRICE |
|-------|--------|-------------------------|---------------|---------|-----------|------------|
|-------|--------|-------------------------|---------------|---------|-----------|------------|

- Select from Chippendale (C), Post (P), Queen Anne (Q) or Tapered (T) leg options to coordinate with Traditional or Contemporary decor.
- Solid wood legs and aprons are standard.
- Shipped RTA (ready to assemble).
- Please specify all substitutions and options.
- 1" thick tops are available in thermally fused laminate (L), high pressure laminate (H) or solid hardwood (W). Please select the appropriate model number for the finish you prefer.
- 3mm edging color coordinated with laminate finish is standard for all tops. Finish MUST BE specified at the time of order.
- Refer to the following lists when selecting a finish color. MUST Specify both a Top Color and Base Color when ordering all tables. Thermally Fused and High Pressure Laminate Tops cannot be manufactured with the exact finish color on the base.
- For custom laminate, custom wood stain or contrasting edge, please contact your Global sales representative for special quotation.

Thermally Fused Laminate (LP) & Suggested coordinating wood finish

| | |
|--------------------------|--------------------------------|
| (AWC) Avant Cherry | (ACM) Cherry on Maple |
| (AWH) Avant Honey | (AHM) Honey on Maple |
| (BRC) Brushed Cobalt | (LHM) Light Honey on Maple |
| (CSJ) Constellation Java | (CJM) Charcoal Java on Maple |
| (DES) Dark Espresso | (ECM) Espresso Cafe on Maple |
| (QTM) Quartered Mahogany | (TMM) Tiger Mahogany on Maple |
| (TFW) Tiger Fruitwood | (TFM) Tiger Fruitwood on Maple |
| (TMA) Tiger Mahogany | (TMM) Tiger Mahogany on Maple |
| (TMP) Tiger Maple | (AVM) Maple on Maple |
| (TWL) Tiger Walnut | (TWM) Tiger Walnut on Maple |
| (WHT) White | (MWM) Medium Walnut on Maple |
| (WCR) Winter Cherry | (WCM) Winter Cherry on Maple |
| (ASN) Asian Night | (ASM) Night |
| (ACJ) Absolute Acajou | (AAM) Absolute |
| (HGT) Hayden Grey | (HGM) Gray |
| (SKC) Shaker Cherry | (SKM) Shaker Cherry |
| (WHC) White Chocolate | (WTM) WC Cream |

High Pressure Laminate (HP) & Suggested coordinating wood finish

| | |
|---------------------------|--------------------------------|
| (W357) Avant Cherry | (ACM) Cherry on Maple |
| (W356) Avant Honey | (AHM) Honey on Maple |
| (BCH) Brushed Cobalt | (LHM) Light Honey on Maple |
| (CJH) Constellation Java | (CJM) Charcoal Java on Maple |
| (W142) Dark Espresso | (ECM) Espresso Cafe on Maple |
| (W313) Quartered Mahogany | (TMM) Tiger Mahogany on Maple |
| (W821) Tiger Fruitwood | (TFM) Tiger Fruitwood on Maple |
| (W822) Tiger Mahogany | (TMM) Tiger Mahogany on Maple |
| (W820) Tiger Maple | (AVM) Maple on Maple |
| (W819) Tiger Walnut | (TWM) Tiger Walnut on Maple |
| (S645) White | (MWM) Medium Walnut on Maple |
| (W149) Winter Cherry | (WCM) Winter Cherry on Maple |
| (CMB) Clear Maple | (AVM) Maple on Maple |
| (EMB) Empire Mahogany | (TMM) Tiger Mahogany on Maple |
| (SKB) Shaker Cherry | (SKM) Shaker Cherry on Maple |

Wood Finishes (W):

(Top, Base, Legs & Apron Finish)

| | | |
|----------------------------------|------------------------------|----------------|
| (BPM) Brandy Peppercorn on Maple | (JOM) Jet Onyx on Maple | (ASM) Night |
| (CJM) Charcoal Java on Maple | (LHM) Light Honey on Maple | (AAM) Absolute |
| (ACM) Cherry on Maple | (MWM) Medium Walnut on Maple | (HGM) Gray |
| (CLM) Cherry Latte on Maple | (TMM) Mahogany on Maple | (WTM) WC Cream |
| (CVM) Cocoa Vanilla on Maple | (AVM) Maple on Maple | |
| (EMM) Empire Mahogany on Maple | (SBM) Sandy Beach on Maple | |
| (EOM) English Oak on Maple | (SKM) Shaker Cherry on Maple | |
| (ECM) Espresso Cafe on Maple | (SOM) Silver Oak on Maple | |
| (TFM) Tiger Fruitwood on Maple | (TWM) Tiger Walnut on Maple | |
| (HOM) Harvest Oak on Maple | (WHM) White on Maple | |
| (AHM) Honey on Maple | (WCM) Winter Cherry on Maple | |

- Queen Anne legs are available in Maple wood Only.

OCCASIONAL TABLES

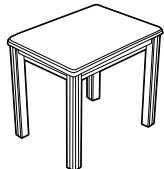

Rectangular End Table

| | | | | | |
|-----------|--------------|-----|-------|------|--------------|
| GC3760-LC | 24 x 18 x 21 | 150 | 26.26 | 5.25 | \$644 |
| GC3760-HC | 24 x 18 x 21 | 150 | 26.26 | 5.25 | \$738 |
| GC3760-WC | 24 x 18 x 21 | 150 | 27.12 | 5.25 | \$772 |

- For a thermally fused top (L), specify model GC3760-LC.
- For a high pressure laminate top (H), specify model GC3760-HC.
- For a wood top (W), specify model GC3760-WC.

Features **Chippendale** legs. 21" high. Standard with solid wood legs and apron.

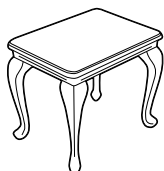

Rectangular End Table

| | | | | | |
|-----------|--------------|-----|-------|------|---------------|
| GC3760-LQ | 24 x 18 x 21 | 150 | 22.44 | 5.25 | \$936 |
| GC3760-HQ | 24 x 18 x 21 | 150 | 22.44 | 5.25 | \$1031 |
| GC3760-WQ | 24 x 18 x 21 | 150 | 23.29 | 5.25 | \$1062 |

- For a thermally fused top (L), specify model GC3760-LQ.
- For a high pressure laminate top (H), specify model GC3760-HQ.
- For a wood top (W), specify model GC3760-WQ.

Features **Queen Anne** legs. 21" high. Standard with solid wood legs and apron.

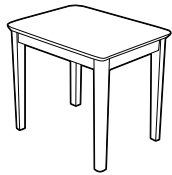

Rectangular End Table

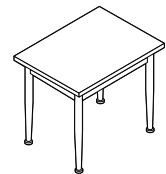

Rectangular End Table

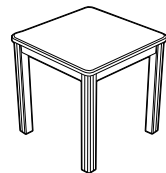

Square End Table

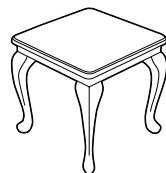

Square End Table

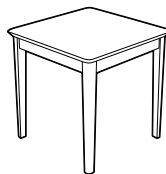

Square End Table

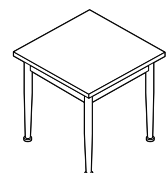

Square End Table

| MODEL# | DIMENSIONS | FREIGHT CLASS | WT/LBS. | CUBIC FT. | LIST PRICE |
|--------|------------|---------------|---------|-----------|------------|
|--------|------------|---------------|---------|-----------|------------|

D x W x H

| | | | | | |
|-----------|--------------|-----|-------|------|--------------|
| GC3760-LT | 24 x 18 x 21 | 150 | 24.69 | 5.25 | \$644 |
| GC3760-HT | 24 x 18 x 21 | 150 | 24.69 | 5.25 | \$738 |
| GC3760-WT | 24 x 18 x 21 | 150 | 25.55 | 5.50 | \$772 |

- For a thermally fused top (L), specify model GC3760-LT.
- For a high pressure laminate top (H), specify model GC3760-HT.
- For a wood top (W), specify model GC3760-WT.

Features **Tapered** legs. 21" high. Standard with solid wood legs and apron.

| | | | | | |
|-----------|--------------|-----|-------|------|---------------|
| GC3760-LP | 24 x 18 x 21 | 150 | 26.30 | 5.25 | \$1154 |
| GC3760-HP | 24 x 18 x 21 | 150 | 26.30 | 5.25 | \$1221 |
| GC3760-WP | 24 x 18 x 21 | 150 | 27.10 | 5.25 | \$1200 |

- For a thermally fused top (L), specify model GC3760-LP
- For a high pressure laminate top (H), specify model GC3760-HP
- For a wood top (W), specify model GC3760-WP

Features **Post** legs. 21" high. Standard with solid wood legs and apron. Post legs are 1 1/3" in diameter.

| | | | | | |
|-----------|--------------|-----|-------|------|--------------|
| GC3761-LC | 21 x 21 x 21 | 150 | 26.48 | 5.50 | \$644 |
| GC3761-HC | 21 x 21 x 21 | 150 | 26.48 | 5.50 | \$738 |
| GC3761-WC | 21 x 21 x 21 | 150 | 27.36 | 5.50 | \$772 |

- For a thermally fused top (L), specify model GC3761-LC.
- For a high pressure laminate top (H), specify model GC3761-HC.
- For a wood top (W), specify model GC3761-WC.

Features **Chippendale** legs. 21" high. Standard with solid wood legs and apron.

| | | | | | |
|-----------|--------------|-----|-------|------|---------------|
| GC3761-LQ | 21 x 21 x 21 | 150 | 22.65 | 5.50 | \$936 |
| GC3761-HQ | 21 x 21 x 21 | 150 | 22.65 | 5.50 | \$1031 |
| GC3761-WQ | 21 x 21 x 21 | 150 | 23.53 | 5.50 | \$1062 |

- For a thermally fused top (L), specify model GC3761-LQ.
- For a high pressure laminate top (H), specify model GC3761-HQ.
- For a wood top (W), specify model GC3761-WQ.

Features **Queen Anne** legs. 21" high. Standard with solid wood legs and apron.

| | | | | | |
|-----------|--------------|-----|-------|------|--------------|
| GC3761-LT | 21 x 21 x 21 | 150 | 24.91 | 5.50 | \$644 |
| GC3761-HT | 21 x 21 x 21 | 150 | 24.91 | 5.50 | \$738 |
| GC3761-WT | 21 x 21 x 21 | 150 | 25.79 | 5.50 | \$772 |

- For a thermally fused top (L), specify model GC3761-LT.
- For a high pressure laminate top (H), specify model GC3761-HT.
- For a wood top (W), specify model GC3761-WT.

Features **Tapered** legs. 21" high. Standard with solid wood legs and apron.

| | | | | | |
|-----------|--------------|-----|-------|------|---------------|
| GC3761-LP | 21 x 21 x 21 | 150 | 26.50 | 5.50 | \$1207 |
| GC3761-HP | 21 x 21 x 21 | 150 | 26.50 | 5.50 | \$1261 |
| GC3761-WP | 21 x 21 x 21 | 150 | 27.40 | 5.50 | \$1200 |

- For a thermally fused top (L), specify model GC3761-LP
- For a high pressure laminate top (H), specify model GC3761-HP
- For a wood top (W), specify model GC3761-WP

Features **Post** legs. 21" high. Standard with solid wood legs and apron. Post legs are 1 1/3" in diameter.

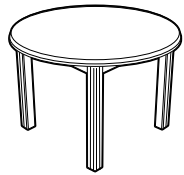

Round End Table

| MODEL# | DIMENSIONS D x W x H | FREIGHT CLASS | WT/LBS. | CUBIC FT. | LIST PRICE |
|-----------|-------------------------|---------------|---------|-----------|------------|
| GC3762-LC | 24 x 24 x 21 | 250 | 26.12 | 7 | \$665 |
| GC3762-HC | 24 x 24 x 21 | 250 | 26.12 | 7 | \$794 |
| GC3762-WC | 24 x 24 x 21 | 250 | 27.02 | 7 | \$828 |

- For a thermally fused top (L), specify model GC3762-LC.
- For a high pressure laminate top (H), specify model GC3762-HC.
- For a wood top (W), specify model GC3762-WC.

Features **Chippendale** legs. 21" high. Standard with solid wood legs and apron.

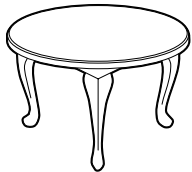

Round End Table

| | | | | | |
|-----------|--------------|-----|-------|---|--------|
| GC3762-LQ | 24 x 24 x 21 | 250 | 22.29 | 7 | \$955 |
| GC3762-HQ | 24 x 24 x 21 | 250 | 22.29 | 7 | \$1083 |
| GC3762-WQ | 24 x 24 x 21 | 250 | 23.15 | 7 | \$1119 |

- For a thermally fused top (L), specify model GC3762-LQ.
- For a high pressure laminate top (H), specify model GC3762-HQ.
- For a wood top (W), specify model GC3762-WQ.

Features **Queen Anne** legs. 21" high. Standard with solid wood legs and apron.



Round End Table

| | | | | | |
|-----------|--------------|-----|-------|------|-------|
| GC3762-LT | 24 x 24 x 21 | 250 | 24 | 8.50 | \$665 |
| GC3762-HT | 24 x 24 x 21 | 250 | 24.55 | 8.50 | \$794 |
| GC3762-WT | 24 x 24 x 21 | 250 | 25.45 | 8.50 | \$828 |

- For a thermally fused top (L), specify model GC3762-LT.
- For a high pressure laminate top (H), specify model GC3762-HT.
- For a wood top (W), specify model GC3762-WT.

Features **Tapered** legs. 21" high. Standard with solid wood legs and apron.

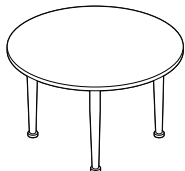

Round End Table

| | | | | | |
|-----------|--------------|-----|-------|---|--------|
| GC3762-LP | 24 x 24 x 22 | 250 | 26.10 | 7 | \$1197 |
| GC3762-HP | 24 x 24 x 22 | 250 | 26.10 | 7 | \$1300 |
| GC3762-WP | 24 x 24 x 22 | 250 | 27 | 7 | \$1282 |

- For a thermally fused top (L), specify model GC3762-LP.
- For a high pressure laminate top (H), specify model GC3762-HP.
- For a wood top (W), specify model GC3762-WP.

Features **Post** legs. 22" high. Post legs are 1 1/3" in diameter.

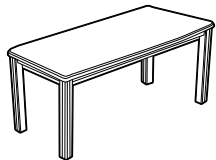

Rectangular Coffee Table

| | | | | | |
|-----------|--------------|-----|-------|-------|--------|
| GC3763-LC | 22 x 48 x 19 | 250 | 43.73 | 11.75 | \$776 |
| GC3763-HC | 22 x 48 x 19 | 250 | 43.73 | 11.75 | \$990 |
| GC3763-WC | 22 x 48 x 19 | 250 | 45.83 | 11.75 | \$1047 |

- For a thermally fused top (L), specify model GC3763-LC.
- For a high pressure laminate top (H), specify model GC3763-HC.
- For a wood top (W), specify model GC3763-WC.

Features **Chippendale** legs. 19" high. Standard with solid wood legs and apron.

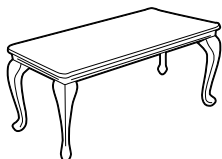

Rectangular Coffee Table

| | | | | | |
|-----------|--------------|-----|-------|-------|--------|
| GC3763-LQ | 22 x 48 x 19 | 250 | 40.05 | 11.75 | \$1065 |
| GC3763-HQ | 22 x 48 x 19 | 250 | 40.05 | 11.75 | \$1280 |
| GC3763-WQ | 22 x 48 x 19 | 250 | 42.16 | 11.75 | \$1337 |

- For a thermally fused top (L), specify model GC3763-LQ.
- For a high pressure laminate top (H), specify model GC3763-HQ.
- For a wood top (W), specify model GC3763-WQ.

Features **Queen Anne** legs. 19" high. Standard with solid wood legs and apron.

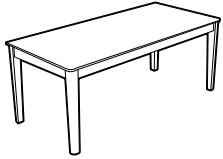

Rectangular Coffee Table

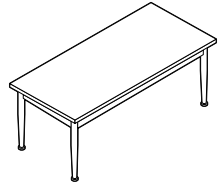

Rectangular Coffee Table

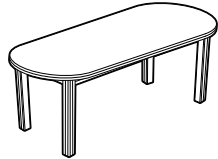

Oval Coffee Table

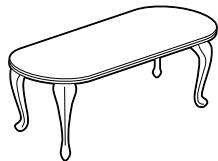

Oval Coffee Table

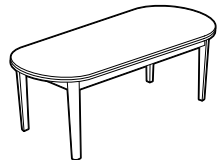

Oval Coffee Table

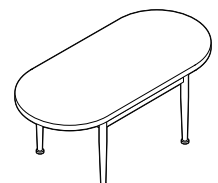

Oval Coffee Table

| MODEL# | DIMENSIONS | FREIGHT CLASS | WT/LBS. | CUBIC FT. | LIST PRICE |
|--------|------------|---------------|---------|-----------|------------|
|--------|------------|---------------|---------|-----------|------------|

D x W x H

| | | | | | |
|-----------|--------------|-----|-------|-------|---------------|
| GC3763-LT | 22 x 48 x 19 | 250 | 42.27 | 11.75 | \$776 |
| GC3763-HT | 22 x 48 x 19 | 250 | 42.27 | 11.75 | \$990 |
| GC3763-WT | 22 x 48 x 19 | 250 | 44.38 | 11.75 | \$1047 |

- For a thermally fused top (L), specify model GC3763-LT.
- For a high pressure laminate top (H), specify model GC3763-HT.
- For a wood top (W), specify model GC3763-WT.

Features **Tapered** legs. 19" high. Standard with solid wood legs and apron.

| | | | | | |
|-----------|--------------|-----|-------|-------|---------------|
| GC3763-LP | 48 x 22 x 19 | 250 | 43.70 | 11.75 | \$1297 |
| GC3763-HP | 48 x 22 x 19 | 250 | 43.70 | 11.75 | \$1500 |
| GC3763-WP | 48 x 22 x 19 | 250 | 45.80 | 11.75 | \$1535 |

- For a thermally fused top (L), specify model GC3763-LP.
- For a high pressure laminate top (H), specify model GC3763-HP.
- For a wood top (W), specify model GC3763-WP.

Features **Post** legs. 19" high. Standard with solid wood legs and apron. Post legs are 1 1/3" in diameter.

| | | | | | |
|-----------|--------------|-----|-------|-------|---------------|
| GC3764-LC | 22 x 46 x 19 | 250 | 38.58 | 11.50 | \$746 |
| GC3764-HC | 22 x 46 x 19 | 250 | 38.58 | 11.50 | \$959 |
| GC3764-WC | 22 x 46 x 19 | 250 | 38.40 | 11.50 | \$1018 |

- For a thermally fused top (L), specify model GC3764-LC.
- For a high pressure laminate top (H), specify model GC3764-HC.
- For a wood top (W), specify model GC3764-WC.

Features **Chippendale** legs. 19" high. Standard with solid wood legs and apron.

| | | | | | |
|-----------|--------------|-----|-------|-------|---------------|
| GC3764-LQ | 22 x 46 x 19 | 250 | 35.91 | 11.50 | \$1037 |
| GC3764-HQ | 22 x 46 x 19 | 250 | 35.91 | 11.50 | \$1249 |
| GC3764-WQ | 22 x 46 x 19 | 250 | 34.72 | 11.50 | \$1308 |

- For a thermally fused top (L), specify model GC3764-LQ.
- For a high pressure laminate top (H), specify model GC3764-HQ.
- For a wood top (W), specify model GC3764-WQ.

Features **Queen Anne** legs. 19" high. Standard with solid wood legs and apron.

| | | | | | |
|-----------|--------------|-----|-------|-------|---------------|
| GC3764-LT | 22 x 46 x 19 | 250 | 37.13 | 11.50 | \$746 |
| GC3764-HT | 22 x 46 x 19 | 250 | 37.13 | 11.50 | \$959 |
| GC3764-WT | 22 x 46 x 19 | 250 | 36.94 | 11.50 | \$1018 |

- For a thermally fused top (L), specify model GC3764-LT.
- For a high pressure laminate top (H), specify model GC3764-HT.
- For a wood top (W), specify model GC3764-WT.

Features **Tapered** legs. 19" high. Standard with solid wood legs and apron.

| | | | | | |
|-----------|--------------|-----|-------|-------|---------------|
| GC3764-LP | 46 x 22 x 19 | 250 | 38.60 | 11.50 | \$1271 |
| GC3764-HP | 46 x 22 x 19 | 250 | 38.60 | 11.50 | \$1479 |
| GC3764-WP | 46 x 22 x 19 | 250 | 38.40 | 11.50 | \$1507 |

- For a thermally fused top (L), specify model GC3763-LP.
- For a high pressure laminate top (H), specify model GC3763-HP.
- For a wood top (W), specify model GC3763-WP.

Features **Post** legs. 19" high. Standard with solid wood legs and apron. Post legs are 1 1/3" in diameter.

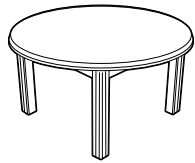

Round Coffee Table

| MODEL# | DIMENSIONS D x W x H | FREIGHT CLASS | WT/LBS. | CUBIC FT. | LIST PRICE |
|-----------|-------------------------|---------------|---------|-----------|---------------|
| GC3765-LC | 32 x 32 x 19 | 250 | 35.15 | 11.50 | \$764 |
| GC3765-HC | 32 x 32 x 19 | 250 | 35.15 | 11.50 | \$978 |
| GC3765-WC | 32 x 32 x 19 | 250 | 36.76 | 11.50 | \$1039 |

- For a thermally fused top (L), specify model GC3765-LC.
- For a high pressure laminate top (H), specify model GC3765-HC.
- For a wood top (W), specify model GC3765-WC.

Features **Chippendale** legs. 19" high. Standard with solid wood legs and apron.



Round Coffee Table

| | | | | | |
|-----------|--------------|-----|-------|-------|---------------|
| GC3765-LQ | 32 x 32 x 19 | 250 | 31.47 | 11.50 | \$1056 |
| GC3765-HQ | 32 x 32 x 19 | 250 | 31.47 | 11.50 | \$1267 |
| GC3765-WQ | 32 x 32 x 19 | 250 | 33.08 | 11.50 | \$1329 |

- For a thermally fused top (L), specify model GC3765-LQ.
- For a high pressure laminate top (H), specify model GC3765-HQ.
- For a wood top (W), specify model GC3765-WQ.

Features **Queen Anne** legs. 19" high. Standard with solid wood legs and apron.



Round Coffee Table

| | | | | | |
|-----------|--------------|-----|-------|-------|---------------|
| GC3765-LT | 32 x 32 x 19 | 250 | 33.69 | 11.50 | \$764 |
| GC3765-HT | 32 x 32 x 19 | 250 | 33.69 | 11.50 | \$978 |
| GC3765-WT | 32 x 32 x 19 | 250 | 35.30 | 11.50 | \$1039 |

- For a thermally fused top (L), specify model GC3765-LT.
- For a high pressure laminate top (H), specify model GC3765-HT.
- For a wood top (W), specify model GC3765-WT.

Features **Tapered** legs. 19" high. Standard with solid wood legs and apron.

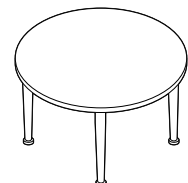

Round Coffee Table

| | | | | | |
|-----------|--------------|-----|-------|-------|---------------|
| GC3765-LP | 32 x 32 x 19 | 250 | 35.20 | 11.50 | \$1290 |
| GC3765-HP | 32 x 32 x 19 | 250 | 35.20 | 11.50 | \$1519 |
| GC3765-WP | 32 x 32 x 19 | 250 | 36.80 | 11.50 | \$1514 |

- For a thermally fused top (L), specify model GC3765-LP.
- For a high pressure laminate top (H), specify model GC3765-HP.
- For a wood top (W), specify model GC3765-WP.

Features **Post** legs. 19" high. Standard with solid wood legs and apron. Post legs are 1 1/3" in diameter.

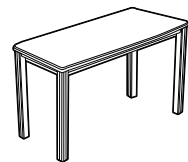

Rectangular Sofa Table

| | | | | | |
|-----------|--------------|-----|-------|-------|--------------|
| GC3766-LC | 16 x 42 x 29 | 250 | 37.62 | 11.50 | \$721 |
| GC3766-HC | 16 x 42 x 29 | 250 | 37.62 | 11.50 | \$866 |
| GC3766-WC | 16 x 42 x 29 | 250 | 38.07 | 11.50 | \$895 |

- For a thermally fused top (L), specify model GC3766-LC.
- For a high pressure laminate top (H), specify model GC3766-HC.
- For a wood top (W), specify model GC3766-WC.

Features **Chippendale** legs. 29" high. Standard with solid wood legs and apron.

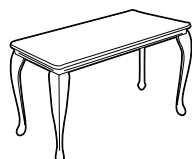

Rectangular Sofa Table

| | | | | | |
|-----------|--------------|-----|-------|-------|---------------|
| GC3766-LQ | 16 x 42 x 29 | 250 | 31.71 | 11.50 | \$1129 |
| GC3766-HQ | 16 x 42 x 29 | 250 | 31.71 | 11.50 | \$1276 |
| GC3766-WQ | 16 x 42 x 29 | 250 | 33.05 | 11.50 | \$1306 |

- For a thermally fused top (L), specify model GC3766-LQ.
- For a high pressure laminate top (H), specify model GC3766-HQ.
- For a wood top (W), specify model GC3766-WQ.

Features **Queen Anne** legs. 29" high. Standard with solid wood legs and apron.

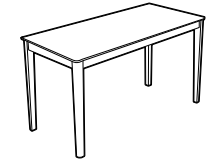

Rectangular Sofa Table

| MODEL# | DIMENSIONS D x W x H | FREIGHT CLASS | WT/LBS. | CUBIC FT. | LIST PRICE |
|-----------|-------------------------|---------------|---------|-----------|--------------|
| GC3766-LT | 16 x 42 x 29 | 250 | 34.58 | 11.50 | \$721 |
| GC3766-HT | 16 x 42 x 29 | 250 | 34.58 | 11.50 | \$866 |
| GC3766-WT | 16 x 42 x 29 | 250 | 35.92 | 11.50 | \$895 |

- For a thermally fused top (L), specify model GC3766-LT.
- For a high pressure laminate top (H), specify model GC3766-HT.
- For a wood top (W), specify model GC3766-WT.

Features **Tapered** legs. 29" high. Standard with solid wood legs and apron.

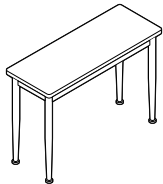

Rectangular Sofa Table

| | | | | | |
|-----------|--------------|-----|-------|-------|---------------|
| GC3766-LP | 16 x 42 x 29 | 250 | 37.60 | 11.50 | \$1246 |
| GC3766-HP | 16 x 42 x 29 | 250 | 37.60 | 11.50 | \$1364 |
| GC3766-WP | 16 x 42 x 29 | 250 | 38.10 | 11.50 | \$1671 |

- For a thermally fused top (L), specify model GC3766-LP.
- For a high pressure laminate top (H), specify model GC3766-HP.
- For a wood top (W), specify model GC3766-WP.

Features **Post** legs. 29" high. Standard with solid wood legs and apron. Post legs are 1 1/3" in diameter.

OCCASIONAL DINING TABLES

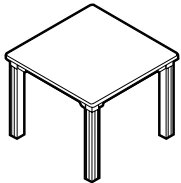

Square Dining Table

| | | | | | |
|-----------|--------------|----|----|------|---------------|
| GC3772-LC | 36 x 36 x 29 | 85 | 50 | 3.90 | \$1388 |
| GC3772-HC | 36 x 36 x 29 | 85 | 50 | 3.90 | \$1549 |
| GC3772-WC | 36 x 36 x 29 | 85 | 50 | 3.90 | \$2206 |

- For a thermally fused top (L), specify model GC3772-LC.
- For a high pressure laminate top (H), specify model GC3772-HC.
- For a wood top (W), specify model GC3772-WC.

Features **Chippendale** legs. 29" high. Standard with solid wood legs and apron.

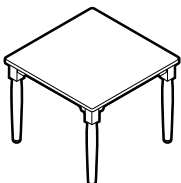

Square Dining Table

| | | | | | |
|-----------|--------------|----|----|------|---------------|
| GC3772-LP | 36 x 36 x 29 | 85 | 50 | 3.90 | \$1388 |
| GC3772-HP | 36 x 36 x 29 | 85 | 50 | 3.90 | \$1549 |
| GC3772-WP | 36 x 36 x 29 | 85 | 50 | 3.90 | \$2206 |

- For a thermally fused top (L), specify model GC3772-LP.
- For a high pressure laminate top (H), specify model GC3772-HP.
- For a wood top (W), specify model GC3772-WP.

Features **Post** legs. 29" high. Standard with solid wood legs and apron. Post legs are 1 1/3" in diameter.

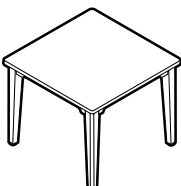

Square Dining Table

| | | | | | |
|-----------|--------------|----|----|------|---------------|
| GC3772-LT | 36 x 36 x 29 | 85 | 50 | 3.90 | \$1388 |
| GC3772-HT | 36 x 36 x 29 | 85 | 50 | 3.90 | \$1549 |
| GC3772-WT | 36 x 36 x 29 | 85 | 50 | 3.90 | \$2206 |

- For a thermally fused top (L), specify model GC3772-LT.
- For a high pressure laminate top (H), specify model GC3772-HT.
- For a wood top (W), specify model GC3772-WT.

Features **Tapered** legs. 29" high. Standard with solid wood legs and apron.

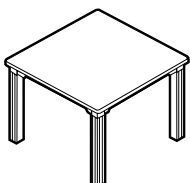

Square Dining Table

| | | | | | |
|-----------|--------------|----|----|------|---------------|
| GC3773-LC | 42 x 42 x 29 | 85 | 68 | 5.50 | \$1494 |
| GC3773-HC | 42 x 42 x 29 | 85 | 68 | 5.50 | \$1712 |
| GC3773-WC | 42 x 42 x 29 | 85 | 68 | 5.50 | \$2670 |

- For a thermally fused top (L), specify model GC3773-LC.
- For a high pressure laminate top (H), specify model GC3773-HC.
- For a wood top (W), specify model GC3773-WC.

Features **Chippendale** legs. 29" high. Standard with solid wood legs and apron.

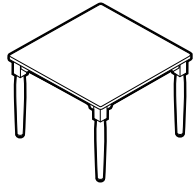

Square Dining Table

| MODEL# | DIMENSIONS D x W x H | FREIGHT CLASS | WT/LBS. | CUBIC FT. | LIST PRICE |
|-----------|-------------------------|---------------|---------|-----------|------------|
| GC3773-LP | 42 x 42 x 29 | 85 | 68 | 5.50 | \$1494 |
| GC3773-HP | 42 x 42 x 29 | 85 | 68 | 5.50 | \$1712 |
| GC3773-WP | 42 x 42 x 29 | 85 | 68 | 5.50 | \$2670 |

- For a thermally fused top (L), specify model GC3773-LP.
- For a high pressure laminate top (H), specify model GC3773-HP.
- For a wood top (W), specify model GC3773-WP.

Features **Post** legs. 29" high. Standard with solid wood legs and apron. Post legs are 1 1/3" in diameter.

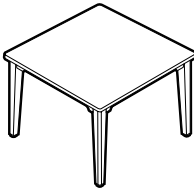

Square Dining Table

| | | | | | |
|-----------|--------------|----|----|------|--------|
| GC3773-LT | 42 x 42 x 29 | 85 | 68 | 5.50 | \$1494 |
| GC3773-HT | 42 x 42 x 29 | 85 | 68 | 5.50 | \$1712 |
| GC3773-WT | 42 x 42 x 29 | 85 | 68 | 5.50 | \$2670 |

- For a thermally fused top (L), specify model GC3773-LT.
- For a high pressure laminate top (H), specify model GC3773-HT.
- For a wood top (W), specify model GC3773-WT.

Features **Tapered** legs. 29" high. Standard with solid wood legs and apron.

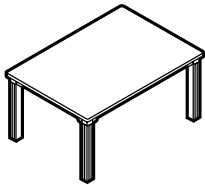

Rectangular Dining Table

| | | | | | |
|-----------|--------------|----|----|------|--------|
| GC3774-LC | 60 x 42 x 29 | 85 | 97 | 7.50 | \$1701 |
| GC3774-HC | 60 x 42 x 29 | 85 | 97 | 7.50 | \$2013 |
| GC3774-WC | 60 x 42 x 29 | 85 | 97 | 7.50 | \$3340 |

- For a thermally fused top (L), specify model GC3774-LC.
- For a high pressure laminate top (H), specify model GC3774-HC.
- For a wood top (W), specify model GC3774-WC.

Features **Chippendale** legs. 29" high. Standard with solid wood legs and apron.

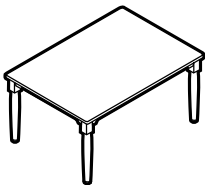

Rectangular Dining Table

| | | | | | |
|-----------|--------------|----|----|------|--------|
| GC3774-LP | 60 x 42 x 29 | 85 | 97 | 7.50 | \$1701 |
| GC3774-HP | 60 x 42 x 29 | 85 | 97 | 7.50 | \$2013 |
| GC3774-WP | 60 x 42 x 29 | 85 | 97 | 7.50 | \$3340 |

- For a thermally fused top (L), specify model GC3774-LP.
- For a high pressure laminate top (H), specify model GC3774-HP.
- For a wood top (W), specify model GC3774-WP.

Features **Post** legs. 29" high. Standard with solid wood legs and apron. Post legs are 1 1/3" in diameter.

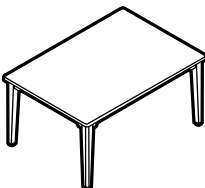

Rectangular Dining Table

| | | | | | |
|-----------|--------------|----|----|------|--------|
| GC3774-LT | 60 x 42 x 29 | 85 | 97 | 7.50 | \$1701 |
| GC3774-HT | 60 x 42 x 29 | 85 | 97 | 7.50 | \$2013 |
| GC3774-WT | 60 x 42 x 29 | 85 | 97 | 7.50 | \$3340 |

- For a thermally fused top (L), specify model GC3774-LT.
- For a high pressure laminate top (H), specify model GC3774-HT.
- For a wood top (W), specify model GC3774-WT.

Features **Tapered** legs. 29" high. Standard with solid wood legs and apron.

| NOTES | MODEL# | DIMENSIONS | FREIGHT CLASS | WT/LBS. | CUBIC FT. | LIST PRICE |
|-------|--------|------------|---------------|---------|-----------|------------|
|-------|--------|------------|---------------|---------|-----------|------------|

D x W x H



- Four on the floor stability. Heavy duty steel legs are available in Black (BLK), Platinum (PLT), Toast (TOA), Storm Grey (SOG) and Tungsten (TUN). Please specify leg finish color when placing order. Cappuccino (T20), Mocha (J52), and Kalua (KAL) are also available by special request.
- Shipped RTA (ready to assemble).
- Adjustable 1.5" range Black plastic glides are standard. EXCEPT Tungsten (TUN) which has Tungsten glides.
- 3mm edging color coordinated with laminate finish is standard for all tops. Finish MUST BE specified at the time of order.
- Tablet Tables are designed to accept the tablet on all sides.
- Please specify all substitutions and options.
- 1" thick tops are available in thermally fused laminate (L) and high pressure laminate (H). Please select the appropriate model number for the finish you prefer.
- Refer to the following lists when selecting a finish color. MUST Specify both a Top Color and Leg Finish when ordering.
- For custom laminate or contrasting edge, please contact your Global sales representative for special quotation.

Thermally Fused Laminate (L)

- (AWC) Avant Cherry
- (AWH) Avant Honey
- (BRC) Brushed Cobalt
- (CSJ) Constellation Java
- (DES) Dark Espresso
- (QTM) Quartered Mahogany
- (TFW) Tiger Fruitwood
- (TMA) Tiger Mahogany
- (TMP) Tiger Maple
- (TWL) Tiger Walnut
- (WHT) White
- (WCR) Winter Cherry

High Pressure Laminate (H)

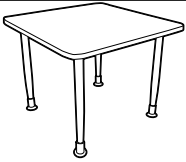
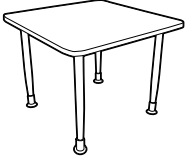
- (W357) Avant Cherry
- (W356) Avant Honey
- (BCH) Brushed Cobalt
- (CJH) Constellation Java
- (W142) Dark Espresso
- (W313) Quartered Mahogany
- (W821) Tiger Fruitwood
- (W822) Tiger Mahogany
- (W820) Tiger Maple
- (W819) Tiger Walnut
- (S645) White
- (W149) Winter Cherry
- (CMB) Clear Maple
- (EMB) Empire Mahogany
- (SKB) Shaker Cherry

| | MODEL# | DIMENSIONS | FREIGHT CLASS | WT/LBS. | CUBIC FT. | LIST PRICE |
|---|----------|----------------|---------------|---------|-----------|---------------|
|  <p>Dining Table - 36"</p> | GC3-36L | 36 x 36 x 29 | 70 | 63.40 | 3.68 | \$788 |
| | GC3-36LH | 36 x 36 x 29 | 70 | 63.40 | 3.68 | \$926 |
| <ul style="list-style-type: none"> • For a thermally fused top (L), specify model GC3-36L. • For a high pressure laminate top (H), specify model GC3-36LH. <p>Standard Black edge. 36" x 36" top accepts a tablet on all sides. Heavy duty steel legs are standard in Black Gloss (BLK). A variety of optional finishes are also available. Please Specify.</p> <ul style="list-style-type: none"> • Additional leg heights are available. Special quote is required. • 2 cartons | | | | | | |
|  <p>Dining Table - 42"</p> | GC3-42L | 42 x 42 x 29 | 70 | 79.65 | 4.20 | \$1020 |
| | GC3-42LH | 42 x 42 x 29 | 70 | 79.65 | 4.20 | \$1180 |
| <ul style="list-style-type: none"> • For a thermally fused top (L), specify model GC3-42L. • For a high pressure laminate top (H), specify model GC3-42LH. <p>Standard Black edge. 42" x 42" top accepts a tablet on all sides. Heavy duty steel legs are standard in Black Gloss (BLK). A variety of optional finishes are also available. Please Specify.</p> <ul style="list-style-type: none"> • Additional leg heights are available. Special quote is required. • 2 cartons | | | | | | |
|  <p>Tablet</p> | GC3-NUG | 24 x 10 x 1.13 | 70 | 15 | .80 | \$329 |
| | GC3-NUGH | 24 x 10 x 1.13 | 70 | 15 | .80 | \$358 |
| <ul style="list-style-type: none"> • For a thermally fused top (L), specify model GC3-NUG. • For a high pressure laminate top (H), specify model GC3-NUGH. <p>Attachable tablet for above Tablet Tables. Attaches on any side to extend table by 24". Heavy duty steel mounting bracket is standard in Black.</p> | | | | | | |



seating
patient room, patient care, reception,
lounge, dining, administration +
all purpose



| | Lobby | Lounge Seating | Guest Seating | Waiting Areas | Bariatric Seating | Exam Room | Patient Room | Resident Room | Dining / Cafeteria |
|--------------------------|-------|----------------|---------------|---------------|-------------------|-----------|--------------|---------------|--------------------|
| Adeline™ | | | • | • | | • | • | • | |
| At-Eez™ | | | | | | | • | • | |
| Aubra | • | | • | • | • | • | • | | |
| Birmingham™ | | | | | | | | | • |
| Bishop | • | • | | • | | | | • | |
| Careflex™ | | | • | • | • | • | • | • | • |
| Chapter™ | • | • | | • | | | | | |
| Desmond™ | | | | | | | | | • |
| Dinah | | | | | | | | | • |
| Frolick, Curtsy & Splash | | | • | • | • | • | • | | |
| GC-Belong | • | | • | • | • | • | • | | |
| GC-Comet™ | | | • | • | • | • | • | | • |
| GC-Wind™ | • | • | | • | | | | | |
| Heather | • | • | • | • | | | | • | |
| Interlock | • | | | • | • | • | • | | |
| Janna™ | | | • | • | | • | • | • | |
| Kensington™ | | | | | | | | | • |
| Majesty™ | • | • | • | • | | | | • | • |
| Nourish | | | | | • | • | • | | |
| Ottomans | | • | | • | | | | • | |
| Pembrooke™ | | • | • | | | | | • | • |
| Phoenix™ | | | | | | | | | • |
| Primacare™ | • | • | • | • | • | | • | • | • |
| Primacare HT™ | • | • | • | • | • | | • | • | • |
| Roosevelt™ | | | | | | | | • | • |
| Savannah™ | | | | | | | | | • |
| Senator™ | • | • | | • | | | | | |
| Strand™ | • | | • | • | • | • | • | | |
| Wellness™ | | | | | | | • | • | • |
| Wingback™ | • | • | • | • | | | | • | |
| York™ | | | • | • | | | • | • | • |

ADELINE



model GC7680



FEATURES

- Flex back moves with the user, providing comfort and support while seated.
- Sleek oval tube steel frame is available in Black (BLK), Platinum (PLT), Toast (TOA), Tungsten (TUN), Cappuccino (T20), Mocha (J52), and Kalua (KAL). Please specify.
- Self-skinned urethane armcaps are available in Black (BLK), Platinum (PLT), Toast (TOA), Cappuccino (T20), Mocha (J52), and Kalua (KAL). Please Specify.
- Standard seat height on all models is 18.5". For 20" seat height, please add "-20" after the first 6 digits of the model number.
- For Globalcare textiles and finish options, visit the web site at www.thinkglobalcare.com.
- This product is shipped fully assembled
- Standard glide is plastic.
- High density Ultracell Bio foam. Moisture Barrier (Seat Only) - Add \$85.00 list upcharge.

- For addition of a Fire Barrier Lining - Add \$65.00 list upcharge per yard.
- Call Customer Service for CAL133 approved textiles.

SUGGESTED APPLICATIONS

- Waiting Areas
- Patient Rooms
- Resident Rooms
- Exam Rooms
- Guest Seating.

| DESCRIPTION | MODEL# | STANDARD FABRIC GRADES | | | | | | | | | | | |
|--|------------------------------|------------------------|--------|--------|-----------------|--------|--------|-----------------|--------|--------|--------|--------|--------|
| | | COM | 2 | 3 | 4 | 5 | 6 | 7 | 8 | 9 | 10 | 11 | 12 |
|  <p>High Back Armchair Flex-Back COM Yardage: 2 Freight Class: 250 Product Weight (lbs.): 40 Cubic Feet Per Carton: 20</p> | GC7680 | \$1127 | \$1146 | \$1241 | \$1295 | \$1374 | \$1402 | \$1470 | \$1599 | \$1664 | \$1782 | \$1948 | \$2153 |
| | GC7680-20 20" seat height | \$1171 | \$1217 | \$1319 | \$1377 | \$1460 | \$1492 | \$1565 | \$1702 | \$1771 | \$1899 | \$2077 | \$2296 |
| | | OVERALL DIMENSIONS | | | SEAT DIMENSIONS | | | BACK DIMENSIONS | | | | | |
| | | W | D | H | W | D | H | W | H | | | | |
| | | 25.5 | 28 | 45 | 19.5 | 18 | 18 | 18 | 30 | | | | |
| | | 25.5 | 28 | 47 | 19.5 | 18 | 20 | 18 | 30 | | | | |
|  <p>High Back Armchair One Piece, Fixed Back COM Yardage: 2 Freight Class: 250 Product Weight (lbs.): 46 Cubic Feet Per Carton: 20</p> | GC7681 | \$1154 | \$1200 | \$1302 | \$1359 | \$1443 | \$1475 | \$1548 | \$1686 | \$1754 | \$1881 | \$2059 | \$2279 |
| | GC7681-20 20" seat height | \$1222 | \$1268 | \$1373 | \$1432 | \$1514 | \$1547 | \$1619 | \$1758 | \$1826 | \$1953 | \$2131 | \$2351 |
| | | OVERALL DIMENSIONS | | | SEAT DIMENSIONS | | | BACK DIMENSIONS | | | | | |
| | | W | D | H | W | D | H | W | H | | | | |
| | | 25.5 | 28 | 45 | 19.5 | 18 | 18 | 18 | 30 | | | | |
| | | 25.5 | 28 | 47 | 19.5 | 18 | 20 | 18 | 30 | | | | |
|  <p>Low Back Armchair Flex-Back COM Yardage: 1.75 Freight Class: 250 Product Weight (lbs.): 42 Cubic Feet Per Carton: 20</p> | GC7682 | \$1062 | \$1102 | \$1135 | \$1184 | \$1254 | \$1280 | \$1341 | \$1456 | \$1513 | \$1620 | \$1768 | \$1950 |
| | GC7682-20 20" seat height | \$1131 | \$1171 | \$1204 | \$1253 | \$1323 | \$1349 | \$1410 | \$1525 | \$1582 | \$1689 | \$1837 | \$2019 |
| | | OVERALL DIMENSIONS | | | SEAT DIMENSIONS | | | BACK DIMENSIONS | | | | | |
| | | W | D | H | W | D | H | W | H | | | | |
| | | 25.5 | 28 | 40 | 19.5 | 18 | 18 | 18 | 22 | | | | |
| | | 25.5 | 28 | 40 | 19.5 | 18 | 18 | 18 | 22 | | | | |

DESCRIPTION

MODEL#

STANDARD FABRIC GRADES



Low Back Armchair Flex-Back
COM Yardage: 1.75
Freight Class: 250
Product Weight (lbs.): 44
Cubic Feet Per Carton: 20

GC7683

| COM | 2 | 3 | 4 | 5 | 6 | 7 | 8 | 9 | 10 | 11 | 12 |
|--------|--------|--------|--------|--------|--------|--------|--------|--------|--------|--------|--------|
| \$1114 | \$1154 | \$1187 | \$1236 | \$1306 | \$1332 | \$1393 | \$1508 | \$1565 | \$1672 | \$1820 | \$2002 |

GC7683-20
20" seat height

| | | | | | | | | | | | |
|--------|--------|--------|--------|--------|--------|--------|--------|--------|--------|--------|--------|
| \$1183 | \$1223 | \$1256 | \$1305 | \$1375 | \$1401 | \$1462 | \$1577 | \$1634 | \$1741 | \$1889 | \$2071 |
|--------|--------|--------|--------|--------|--------|--------|--------|--------|--------|--------|--------|

OVERALL DIMENSIONS

| W | D | H |
|------|----|----|
| 25.5 | 28 | 40 |
| 25.5 | 28 | 42 |

SEAT DIMENSIONS

| W | D | H |
|------|----|----|
| 19.5 | 18 | 18 |
| 19.5 | 18 | 20 |

BACK DIMENSIONS

| W | H |
|----|----|
| 18 | 22 |
| 18 | 22 |

AT-EEZ



model **GC3779**



model **GC3779, open**

STANDARD FEATURES

- Converts instantly into sleeping accommodations with storage for blankets and pillows.
- Eight double wheel casters for easy mobility with locking feature on four of the casters.
- Two coordinating textile covered nylon straps are provided on the back to pull up and return the sleeping platform to a seated position.
- Wood armcaps are available in a variety of finishes. **Available in Maple wood Only.**
- For Globalcare textiles and wood finish options, visit the web site at www.thinkglobalcare.com.
- This product can be upholstered in standard

Global textiles only if Healthcare compliance is not required.

- This product is shipped fully assembled.
- Hard surface 3" dual wheel locking casters (C83R) for arm structure are standard.
- Seat is made from 3" Ultracell foam for added comfort. **Moisture Barrier (Seat Only) - Add \$127.00** list upcharge.
- For addition of a Fire Barrier Lining - **Add \$65.00** list upcharge per yard.
- Call Customer Service for CAL133 approved textiles.

SUGGESTED APPLICATIONS

- Patient Rooms
- Resident Rooms

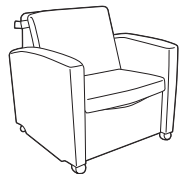

GC3758

| COM | 2 | 3 | 4 | 5 | 6 | 7 | 8 | 9 | 10 | 11 | 12 |
|--------|--------|--------|--------|--------|--------|--------|--------|--------|--------|--------|--------|
| \$2653 | \$2851 | \$3011 | \$3249 | \$3587 | \$3715 | \$4011 | \$4568 | \$4846 | \$5364 | \$6082 | \$6970 |

OVERALL DIMENSIONS

| W | D | H |
|----|------|----|
| 38 | 33.2 | 40 |

SEAT DIMENSIONS

| W | D | H |
|----|------|----|
| 30 | 18.5 | 18 |

BACK DIMENSIONS

| W | H |
|----|------|
| 30 | 19.5 |

Lounge Chair / Sleeper Chair 30" wide, Upholstered Armcaps
COM Yardage: 8.50
Freight Class: 150
Product Weight (lbs.): 131
Cubic Feet Per Carton: 32.25

Sleep surface is 30 1/2"W x 75"L. Platform based. Upholstered with steel linen storage compartment. Casters.
• **Not for Bariatric use**

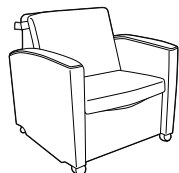

GC3759

| COM | 2 | 3 | 4 | 5 | 6 | 7 | 8 | 9 | 10 | 11 | 12 |
|--------|--------|--------|--------|--------|--------|--------|--------|--------|--------|--------|--------|
| \$2850 | \$3048 | \$3208 | \$3446 | \$3784 | \$3912 | \$4208 | \$4765 | \$5043 | \$5561 | \$6279 | \$7167 |

OVERALL DIMENSIONS

| W | D | H |
|----|------|----|
| 38 | 33.2 | 40 |

SEAT DIMENSIONS

| W | D | H |
|----|------|----|
| 30 | 18.5 | 18 |

BACK DIMENSIONS

| W | H |
|----|------|
| 30 | 19.5 |

Lounge Chair / Sleeper Chair 30" wide, Wood Armcaps
COM Yardage: 8.50
Freight Class: 150
Product Weight (lbs.): 131
Cubic Feet Per Carton: 32.25

Sleep surface is 30 1/2"W x 75"L. Platform based. Upholstered with steel linen storage compartment. Casters.
• **Not for Bariatric use**

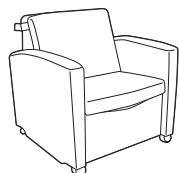

GC3778

| COM | 2 | 3 | 4 | 5 | 6 | 7 | 8 | 9 | 10 | 11 | 12 |
|--------|--------|--------|--------|--------|--------|--------|--------|--------|--------|--------|--------|
| \$2102 | \$2242 | \$2478 | \$2665 | \$2928 | \$3026 | \$3257 | \$3692 | \$3905 | \$4308 | \$4866 | \$5557 |

OVERALL DIMENSIONS

| W | D | H |
|----|----|------|
| 32 | 32 | 34.5 |

SEAT DIMENSIONS

| W | D | H |
|----|------|------|
| 24 | 18.5 | 16.5 |

BACK DIMENSIONS

| W | H |
|----|----|
| 24 | 17 |

Lounge Chair / Sleeper Chair 24" wide, Upholstered Armcaps
COM Yardage: 6.75
Freight Class: 250
Product Weight (lbs.): 110
Cubic Feet Per Carton: 28.50

Sleep surface is 24 1/2"W x 71"L. Platform based. Upholstered with steel linen storage compartment. Casters.
• **Not for Bariatric use**

| DESCRIPTION | MODEL# | STANDARD FABRIC GRADES | | | | | | | | | | | |
|-------------|--------|------------------------|---|---|---|---|---|---|---|---|----|----|----|
| | | COM | 2 | 3 | 4 | 5 | 6 | 7 | 8 | 9 | 10 | 11 | 12 |

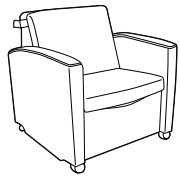

GC3779

| | | | | | | | | | | | |
|--------|--------|--------|--------|--------|--------|--------|--------|--------|--------|--------|--------|
| \$2259 | \$2399 | \$2644 | \$2828 | \$3093 | \$3192 | \$3421 | \$3854 | \$4071 | \$4473 | \$5032 | \$5722 |
|--------|--------|--------|--------|--------|--------|--------|--------|--------|--------|--------|--------|

| OVERALL DIMENSIONS | | | SEAT DIMENSIONS | | | BACK DIMENSIONS | |
|--------------------|----|------|-----------------|------|------|-----------------|----|
| W | D | H | W | D | H | W | H |
| 32 | 32 | 34.5 | 24 | 18.5 | 16.5 | 24 | 17 |

Lounge Chair / Sleeper Chair 24" wide, Wood Armcaps
 COM Yardage: 6.75
 Freight Class: 250
 Product Weight (lbs.): 110
 Cubic Feet Per Carton: 28.50

Sleep surface is 24 1/2"W x 71"L. Platform based. Upholstered with steel linen storage compartment. Casters.
 • **Not for Bariatric use**

AUBRA



model GC4181HB

model GC4182HB

FEATURES

- The Aubra frame reflects the fluidity of movement with soft tubular curves.
- All models are standard with a 1 3/4" steel tubular frame.
- Frame available in Black (BLK), Tungsten (TUN), Platinum (PLT), Toast (TOA), Cappuccino (T20), Mocha (J52), and Kalua (KAL). Please specify at time of order placement.
- The frame can be weighted and made with tamper proof fasteners for greater security in more challenging mental health spaces or correctional facilities.
- The seat and back are removable and field replaceable.
- All seats are standard with High Density Ultracell foam.
- All Seat Frames feature a wallsaver design to prevent back contact with wall.
- Ottomans and Benches **do not** have wallsaver legs.
- Standard seat height on all models is 18.5".
- Table heights are 16".
- Cleanout space is provided between the seat and back cushions for easier housekeeping.
- Non-marking glides suitable for hard surface floors, including linoleum.
- As an option, seams can be sealed to prevent penetration of fluids through the stitching. Please contact customer service for more information.
- Moisture Barrier (Seat Only) - **Add \$85.00** list upcharge per seat. For Bariatric models - **Add \$131.00** list upcharge per seat.
- The seat cushion is slightly inclined to enhance comfort. An optional flat seat cushion is also available. Please specify **UPF** - **Add \$45.00** list upcharge per seat. For Bariatric models - **Add \$69.00** list upcharge.
- **Left and Right Position Reference** is determined based on being seated in the chair.
- Active weight capacity for standard single seat is 350 lbs. and 750 lbs for Bariatric Seating.
- For Globalcare textiles and wood finish options, visit the web site at www.thinkglobalcare.com.
- This product can be upholstered in standard Global textiles if healthcare compliance is not required.
- For addition of a Fire Barrier Lining - **Add \$65.00** list upcharge per yard..
- Call Customer Service for **CAL133** approved textiles.

SUGGESTED APPLICATIONS

- Waiting Areas
- Patient Rooms
- Resident Rooms
- Exam Rooms
- Guest Seating

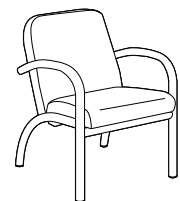

GC4181

| | | | | | | | | | | | |
|-------|-------|-------|-------|--------|--------|--------|--------|--------|--------|--------|--------|
| \$850 | \$890 | \$923 | \$972 | \$1042 | \$1068 | \$1129 | \$1244 | \$1301 | \$1408 | \$1556 | \$1738 |
|-------|-------|-------|-------|--------|--------|--------|--------|--------|--------|--------|--------|

| OVERALL DIMENSIONS | | | SEAT DIMENSIONS | | | BACK DIMENSIONS | |
|--------------------|------|----|-----------------|----|----|-----------------|----|
| W | D | H | W | D | H | W | H |
| 24.5 | 27.5 | 35 | 21 | 18 | 18 | 21 | 17 |

Low Back Single Seat Armchair
 COM Yardage: 1.75
 Freight Class: 250
 Product Weight (lbs.): 46
 Cubic Feet Per Carton: 17.50

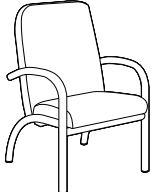
| DESCRIPTION | MODEL# | STANDARD FABRIC GRADES | | | | | | | | | | | |
|--|----------|------------------------|-------|-------|-----------------|--------|--------|-----------------|--------|--------|--------|--------|--------|
| | | COM | 2 | 3 | 4 | 5 | 6 | 7 | 8 | 9 | 10 | 11 | 12 |
|  <p>High Back Single Seat Armchair COM Yardage: 2 Freight Class: 250 Product Weight (lbs.): 50 Cubic Feet Per Carton: 20</p> | GC4181HB | \$901 | \$946 | \$985 | \$1041 | \$1121 | \$1151 | \$1221 | \$1352 | \$1418 | \$1539 | \$1708 | \$1917 |
| | | OVERALL DIMENSIONS | | | SEAT DIMENSIONS | | | BACK DIMENSIONS | | | | | |
| | | W | D | H | W | D | H | W | H | | | | |
| | | 24.5 | 27.5 | 39 | 21 | 18 | 18 | 21 | 21 | | | | |

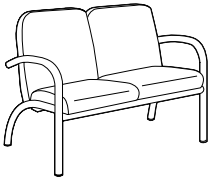
| | | | | | | | | | | | | | |
|---|--------|--------------------|--------|--------|-----------------|--------|--------|-----------------|--------|--------|--------|--------|--------|
|  <p>Low Back Two Seat Chair No Center Arm COM Yardage: 3.25 Freight Class: 300 Product Weight (lbs.): 80 Cubic Feet Per Carton: 46.25</p> | GC4182 | COM | 2 | 3 | 4 | 5 | 6 | 7 | 8 | 9 | 10 | 11 | 12 |
| | | \$1286 | \$1361 | \$1422 | \$1514 | \$1643 | \$1692 | \$1805 | \$2018 | \$2124 | \$2322 | \$2597 | \$2936 |
| | | OVERALL DIMENSIONS | | | SEAT DIMENSIONS | | | BACK DIMENSIONS | | | | | |
| | | W | D | H | W | D | H | W | H | | | | |
| | | 46.5 | 27.5 | 35 | 43 | 18 | 18 | 43 | 17 | | | | |

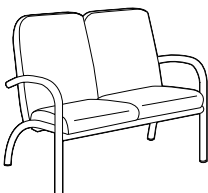
| | | | | | | | | | | | | | |
|---|----------|--------------------|--------|--------|-----------------|--------|--------|-----------------|--------|--------|--------|--------|--------|
|  <p>High Back Two Seat Chair No Center Arm COM Yardage: 3.50 Freight Class: 300 Product Weight (lbs.): 85 Cubic Feet Per Carton: 53.75</p> | GC4182HB | COM | 2 | 3 | 4 | 5 | 6 | 7 | 8 | 9 | 10 | 11 | 12 |
| | | \$1390 | \$1472 | \$1538 | \$1636 | \$1775 | \$1828 | \$1949 | \$2179 | \$2293 | \$2506 | \$2802 | \$3168 |
| | | OVERALL DIMENSIONS | | | SEAT DIMENSIONS | | | BACK DIMENSIONS | | | | | |
| | | W | D | H | W | D | H | W | H | | | | |
| | | 46.5 | 27.5 | 39 | 43 | 18 | 18 | 43 | 21 | | | | |

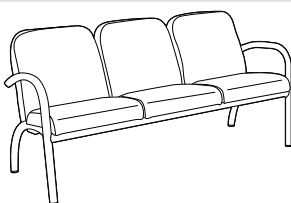
| | | | | | | | | | | | | | |
|---|--------|--------------------|--------|--------|-----------------|--------|--------|-----------------|--------|--------|--------|--------|--------|
|  <p>Low Back Three Seat Chair No Center Arm COM Yardage: 4.75 Freight Class: 300 Product Weight (lbs.): 104 Cubic Feet Per Carton: 60</p> | GC4183 | COM | 2 | 3 | 4 | 5 | 6 | 7 | 8 | 9 | 10 | 11 | 12 |
| | | \$1872 | \$1983 | \$2073 | \$2206 | \$2395 | \$2466 | \$2632 | \$2943 | \$3098 | \$3387 | \$3789 | \$4285 |
| | | OVERALL DIMENSIONS | | | SEAT DIMENSIONS | | | BACK DIMENSIONS | | | | | |
| | | W | D | H | W | D | H | W | H | | | | |
| | | 68.5 | 27.5 | 35 | 65 | 18 | 18 | 65 | 17 | | | | |

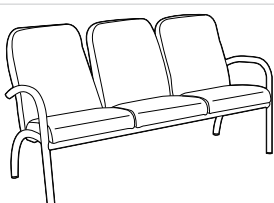
| | | | | | | | | | | | | | |
|--|----------|--------------------|--------|--------|-----------------|--------|--------|-----------------|--------|--------|--------|--------|--------|
|  <p>High Back Three Seat Chair No Center Arm COM Yardage: 5.25 Freight Class: 300 Product Weight (lbs.): 112 Cubic Feet Per Carton: 75</p> | GC4183HB | COM | 2 | 3 | 4 | 5 | 6 | 7 | 8 | 9 | 10 | 11 | 12 |
| | | \$2029 | \$2151 | \$2250 | \$2397 | \$2606 | \$2685 | \$2868 | \$3211 | \$3384 | \$3703 | \$4147 | \$4695 |
| | | OVERALL DIMENSIONS | | | SEAT DIMENSIONS | | | BACK DIMENSIONS | | | | | |
| | | W | D | H | W | D | H | W | H | | | | |
| | | 68.5 | 27.5 | 39 | 65 | 18 | 18 | 65 | 21 | | | | |

SEATING

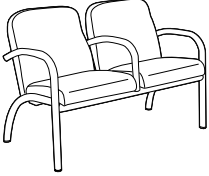
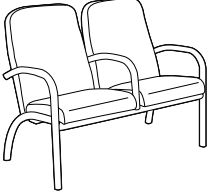
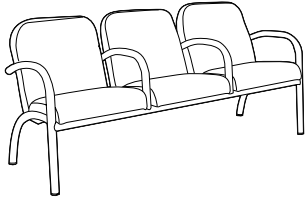
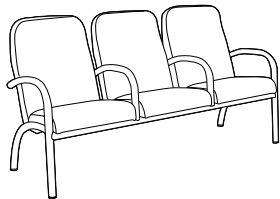
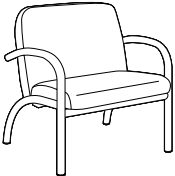
| DESCRIPTION | MODEL# | STANDARD FABRIC GRADES | | | | | | | | | | | |
|---|----------|------------------------|--------|--------|-----------------|--------|--------|-----------------|--------|--------|--------|--------|--------|
| | | COM | 2 | 3 | 4 | 5 | 6 | 7 | 8 | 9 | 10 | 11 | 12 |
|  <p>Low Back Two Seat Chair Half Center Arm COM Yardage: 3.25 Freight Class: 300 Product Weight (lbs.): 85 Cubic Feet Per Carton: 46.25</p> | GC4184 | \$1404 | \$1479 | \$1540 | \$1632 | \$1761 | \$1810 | \$1923 | \$2136 | \$2242 | \$2440 | \$2715 | \$3054 |
| | | OVERALL DIMENSIONS | | | SEAT DIMENSIONS | | | BACK DIMENSIONS | | | | | |
| | | W | D | H | W | D | H | W | H | | | | |
| | | | | | | | | | | | | | |
|  <p>High Back Two Seat Chair Half Center Arm COM Yardage: 3.50 Freight Class: 300 Product Weight (lbs.): 90 Cubic Feet Per Carton: 53.75</p> | GC4184HB | \$1508 | \$1590 | \$1656 | \$1754 | \$1893 | \$1946 | \$2068 | \$2297 | \$2411 | \$2624 | \$2920 | \$3286 |
| | | OVERALL DIMENSIONS | | | SEAT DIMENSIONS | | | BACK DIMENSIONS | | | | | |
| | | W | D | H | W | D | H | W | H | | | | |
| | | | | | | | | | | | | | |
|  <p>Low Back Three Seat Chair Half Center Arms COM Yardage: 4.75 Freight Class: 300 Product Weight (lbs.): 112 Cubic Feet Per Carton: 60</p> | GC4185 | \$2108 | \$2219 | \$2309 | \$2442 | \$2631 | \$2702 | \$2868 | \$3179 | \$3334 | \$3623 | \$4025 | \$4521 |
| | | OVERALL DIMENSIONS | | | SEAT DIMENSIONS | | | BACK DIMENSIONS | | | | | |
| | | W | D | H | W | D | H | W | H | | | | |
| | | | | | | | | | | | | | |
|  <p>High Back Three Seat Chair Half Center Arms COM Yardage: 5.25 Freight Class: 300 Product Weight (lbs.): 117 Cubic Feet Per Carton: 75</p> | GC4185HB | \$2265 | \$2387 | \$2487 | \$2634 | \$2842 | \$2921 | \$3104 | \$3448 | \$3619 | \$3939 | \$4383 | \$4931 |
| | | OVERALL DIMENSIONS | | | SEAT DIMENSIONS | | | BACK DIMENSIONS | | | | | |
| | | W | D | H | W | D | H | W | H | | | | |
| | | | | | | | | | | | | | |
|  <p>Bariatric Low Back Armchair COM Yardage: 3.25 Freight Class: 250 Product Weight (lbs.): 70 Cubic Feet Per Carton: 30.50</p> | GC4186 | \$1032 | \$1108 | \$1169 | \$1261 | \$1390 | \$1439 | \$1552 | \$1765 | \$1871 | \$2069 | \$2344 | \$2683 |
| | | OVERALL DIMENSIONS | | | SEAT DIMENSIONS | | | BACK DIMENSIONS | | | | | |
| | | W | D | H | W | D | H | W | H | | | | |
| | | | | | | | | | | | | | |

• For users up to 750 lbs.

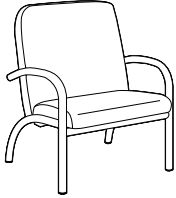

| DESCRIPTION | MODEL# | STANDARD FABRIC GRADES | | | | | | | | | | | |
|--|----------|------------------------------------|--------|--------|---------------------------------|--------|--------|-------------------------------|--------|--------|--------|--------|--------|
| | | COM | 2 | 3 | 4 | 5 | 6 | 7 | 8 | 9 | 10 | 11 | 12 |
|  <p>Bariatric High Back Armchair COM Yardage: 3.50 Freight Class: 250 Product Weight (lbs.): 74 Cubic Feet Per Carton: 30.50</p> | GC4186HB | \$1086 | \$1168 | \$1234 | \$1332 | \$1471 | \$1524 | \$1645 | \$1875 | \$1989 | \$2202 | \$2498 | \$2864 |
| | | OVERALL DIMENSIONS W D H | | | SEAT DIMENSIONS W D H | | | BACK DIMENSIONS W H | | | | | |
| | | 35.5 | 27.5 | 39 | | 32 | 18 | 18 | | 32 | 21 | | |

• For users up to 750 lbs.

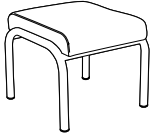
| | | | | | | | | | | | | | |
|--|--------|------------------------------------|-------|-------|---------------------------------|-------|-------|-------------------------------|-------|-------|--------|--------|--------|
|  <p>Single Seat Bench COM Yardage: 1.25 Freight Class: 250 Product Weight (lbs.): 32 Cubic Feet Per Carton: 8.50</p> | GC4187 | COM | 2 | 3 | 4 | 5 | 6 | 7 | 8 | 9 | 10 | 11 | 12 |
| | | \$662 | \$691 | \$715 | \$750 | \$800 | \$819 | \$863 | \$944 | \$985 | \$1061 | \$1167 | \$1297 |
| | | OVERALL DIMENSIONS W D H | | | SEAT DIMENSIONS W D H | | | BACK DIMENSIONS W H | | | | | |
| | | 24.5 | 24 | 18 | | 21 | -- | 18 | | | | | |

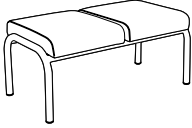
| | | | | | | | | | | | | | |
|---|--------|------------------------------------|--------|--------|---------------------------------|--------|--------|-------------------------------|--------|--------|--------|--------|--------|
|  <p>Two Seat Bench COM Yardage: 2 Freight Class: 250 Product Weight (lbs.): 55 Cubic Feet Per Carton: 23</p> | GC4188 | COM | 2 | 3 | 4 | 5 | 6 | 7 | 8 | 9 | 10 | 11 | 12 |
| | | \$956 | \$1002 | \$1039 | \$1096 | \$1175 | \$1205 | \$1275 | \$1406 | \$1472 | \$1593 | \$1762 | \$1971 |
| | | OVERALL DIMENSIONS W D H | | | SEAT DIMENSIONS W D H | | | BACK DIMENSIONS W H | | | | | |
| | | 46.5 | 24 | 18 | | 21 | -- | 18 | | | | | |

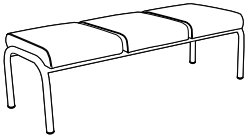
| | | | | | | | | | | | | | |
|--|--------|------------------------------------|--------|--------|---------------------------------|--------|--------|-------------------------------|--------|--------|--------|--------|--------|
|  <p>Three Seat Bench COM Yardage: 2.25 Freight Class: 250 Product Weight (lbs.): 82 Cubic Feet Per Carton: 33.25</p> | GC4189 | COM | 2 | 3 | 4 | 5 | 6 | 7 | 8 | 9 | 10 | 11 | 12 |
| | | \$1259 | \$1311 | \$1354 | \$1416 | \$1506 | \$1540 | \$1618 | \$1766 | \$1840 | \$1977 | \$2167 | \$2402 |
| | | OVERALL DIMENSIONS W D H | | | SEAT DIMENSIONS W D H | | | BACK DIMENSIONS W H | | | | | |
| | | 68.5 | 24 | 18 | | 21 | -- | 18 | | | | | |

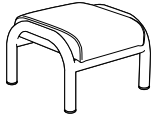
| | | | | | | | | | | | | | |
|---|--------|------------------------------------|-------|-------|---------------------------------|-------|-------|-------------------------------|-------|-------|-------|-------|--------|
|  <p>Ottoman Angled top. COM Yardage: 1 Freight Class: 125 Product Weight (lbs.): 22 Cubic Feet Per Carton: 3.50</p> | GC4190 | COM | 2 | 3 | 4 | 5 | 6 | 7 | 8 | 9 | 10 | 11 | 12 |
| | | \$557 | \$580 | \$599 | \$627 | \$667 | \$683 | \$717 | \$783 | \$816 | \$876 | \$961 | \$1065 |
| | | OVERALL DIMENSIONS W D H | | | SEAT DIMENSIONS W D H | | | BACK DIMENSIONS W H | | | | | |
| | | 18 | 18 | 12.5 | | 18 | -- | 12.5 | | | | | |

Stores beneath any standard seating unit.

| TABLES | MODEL# | DIMENSIONS | FREIGHT CLASS | WT/LBS. | CUBIC FT. | LIST PRICE |
|--------|--------|------------|---------------|---------|-----------|------------|
|--------|--------|------------|---------------|---------|-----------|------------|

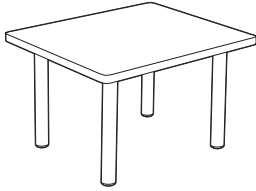

Rectangular End Table

| | D x W x H | | | | | |
|-----------|--------------|-----|----|------|--|--------------|
| GC4191-LP | 22 x 26 x 16 | 100 | 25 | 3.10 | | \$567 |
| GC4191-HP | 22 x 26 x 16 | 100 | 25 | 3.10 | | \$650 |

- For a thermally fused laminate top (LP), specify model GC4191-LP
- For a high pressure laminate top (HP), specify model GC4191-HP.

1" thick top with coordinating 3mm edge and 1 3/4" dia. steel tubular legs

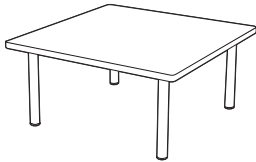

Corner Table Square

| | | | | | | |
|-----------|--------------|-----|----|---|--|--------------|
| GC4192-LP | 34 x 34 x 16 | 125 | 46 | 6 | | \$698 |
| GC4192-HP | 34 x 34 x 16 | 125 | 46 | 6 | | \$836 |

- For a thermally fused laminate top (LP), specify model GC4192-LP
- For a high pressure laminate top (HP), specify model GC4192-HP.

1" thick top with coordinating 3mm edge and 1 3/4" dia. steel tubular legs

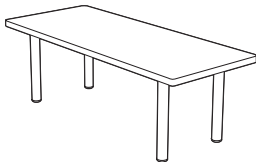

Coffee Table Rectangular

| | | | | | | |
|-----------|--------------|-----|----|------|--|--------------|
| GC4193-LP | 20 x 48 x 16 | 125 | 37 | 5.75 | | \$662 |
| GC4193-HP | 20 x 48 x 16 | 125 | 37 | 5.75 | | \$789 |

- For a thermally fused laminate top (LP), specify model GC4193-LP
- For a high pressure laminate top (HP), specify model GC4193-HP.

1" thick top with coordinating 3mm edge and 1 3/4" dia. steel tubular legs

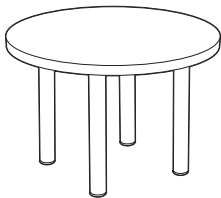

24" Round Table

| | | | | | | |
|-----------|--------------|-----|----|------|--|--------------|
| GC4194-LP | 24 x 24 x 16 | 125 | 25 | 3.40 | | \$551 |
| GC4194-HP | 24 x 24 x 16 | 125 | 25 | 3.40 | | \$602 |

- For a thermally fused laminate top (LP), specify model GC4194-LP
- For a high pressure laminate top (HP), specify model GC4194-HP.

1" thick top with coordinating 3mm edge and 1 3/4" dia. steel tubular legs

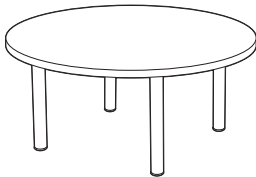

36" Round Table

| | | | | | | |
|-----------|--------------|-----|----|---|--|--------------|
| GC4195-LP | 36 x 36 x 16 | 125 | 42 | 6 | | \$673 |
| GC4195-HP | 36 x 36 x 16 | 125 | 42 | 6 | | \$726 |

- For a thermally fused laminate top (LP), specify model GC4194-LP
- For a high pressure laminate top (HP), specify model GC4194-HP.

1" thick top with coordinating 3mm edge and 1 3/4" dia. steel tubular legs

BIRMINGHAM



model GC4163

STANDARD FEATURES

- Unique carved wood back design and flawless curves.
- Contoured arms with firm grip extension assist users in the entry and exit from the chair.
- Additional leg support bars complement the leg frame and ensure strength and durability.
- For Globalcare textiles and wood finish options, visit the web site at www.thinkglobalcare.com. **Available in European Beech Wood Only (Refer to finishes that end with an "M").**
- This product is shipped fully assembled.
- Standard glide is plastic. For Non-slip glides specify (NS) - **Add \$21.00** list upcharge.

- Seat is made from Ultracell foam for added comfort. Moisture Barrier (Seat Only) - **Add \$85.00** list upcharge.
- For addition of a Fire Barrier Lining - **Add \$65.00** list upcharge per yard.
- Call Customer Service for **CAL133** approved textiles.

SUGGESTED APPLICATIONS

- Dining Rooms

DESCRIPTION

MODEL#

STANDARD FABRIC GRADES

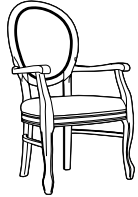

GC4163

| COM | 2 | 3 | 4 | 5 | 6 | 7 | 8 | 9 | 10 | 11 | 12 |
|--------|--------|--------|--------|--------|--------|--------|--------|--------|--------|--------|--------|
| \$1402 | \$1431 | \$1526 | \$1561 | \$1611 | \$1630 | \$1672 | \$1754 | \$1796 | \$1871 | \$1976 | \$2106 |

OVERALL DIMENSIONS

W D H

23.5 24 40.5

SEAT DIMENSIONS

W D H

21 19 18

BACK DIMENSIONS

W H

18.5 20

Armchair

COM Yardage: 1.25
 Freight Class: 300
 Product Weight (lbs.): 25
 Cubic Feet Per Carton: 16.25

BISHOP



model GC4163

STANDARD FEATURES

- Traditional styling and details combined with modern healthcare function.
- Bishop features removable and replaceable seats cushions.
- Wood frame and hardwood block legs are available in a variety of finishes. **Available in Maple wood Only.**
- For Globalcare textiles and wood finish options, visit the web site at www.thinkglobalcare.com.
- This product can be upholstered in standard Global textiles only if Healthcare compliance is not required.
- This product is shipped fully assembled.

- Standard glide is plastic. For Non-slip glides specify (NS) - **Add \$21.00** list upcharge.
- Seat is made from Ultracell foam for added comfort. Moisture Barrier (Seat Only) - **Add \$127.00** list upcharge per seat.
- For addition of a Fire Barrier Lining - **Add \$65.00** list upcharge per yard.
- Call Customer Service for **CAL133** approved textiles.

SUGGESTED APPLICATIONS

- Waiting Areas
- Lobbies
- Lounges

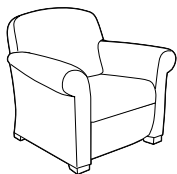

GC3751

| COM | 2 | 3 | 4 | 5 | 6 | 7 | 8 | 9 | 10 | 11 | 12 |
|--------|--------|--------|--------|--------|--------|--------|--------|--------|--------|--------|--------|
| \$1660 | \$1829 | \$1966 | \$2169 | \$2457 | \$2566 | \$2819 | \$3293 | \$3531 | \$3972 | \$4585 | \$5342 |

OVERALL DIMENSIONS

W D H

37 32 34.5

SEAT DIMENSIONS

W D H

21 18.5 17

BACK DIMENSIONS

W H

28 17.5

Lounge Chair

COM Yardage: 7.25
 Freight Class: 250
 Product Weight (lbs.): 75
 Cubic Feet Per Carton: 30.25

Loose seat cushion.

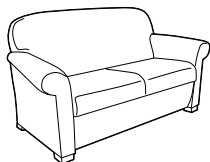

GC3752

| COM | 2 | 3 | 4 | 5 | 6 | 7 | 8 | 9 | 10 | 11 | 12 |
|--------|--------|--------|--------|--------|--------|--------|--------|--------|--------|--------|--------|
| \$2346 | \$2550 | \$2715 | \$2960 | \$3308 | \$3440 | \$3744 | \$4317 | \$4604 | \$5136 | \$5876 | \$6790 |

OVERALL DIMENSIONS

W D H

63.5 32 34.5

SEAT DIMENSIONS

W D H

47.5 18.5 17

BACK DIMENSIONS

W H

55 17.5

Two Seat Sofa

COM Yardage: 8.75
 Freight Class: 250
 Product Weight (lbs.): 112
 Cubic Feet Per Carton: 55.75

Loose seat cushions.

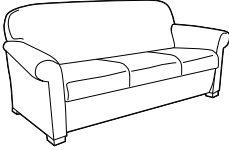
| DESCRIPTION | MODEL# | STANDARD FABRIC GRADES | | | | | | | | | | | |
|--|--------|------------------------|--------|--------|-----------------|--------|--------|-----------------|--------|--------|--------|--------|--------|
| | | COM | 2 | 3 | 4 | 5 | 6 | 7 | 8 | 9 | 10 | 11 | 12 |
|  Three Seat Sofa COM Yardage: 12 Freight Class: 250 Product Weight (lbs.): 155 Cubic Feet Per Carton: 74.75 | GC3753 | \$3473 | \$3722 | \$4130 | \$4460 | \$4927 | \$5102 | \$5513 | \$6282 | \$6666 | \$7381 | \$8375 | \$9602 |
| | | OVERALL DIMENSIONS | | | SEAT DIMENSIONS | | | BACK DIMENSIONS | | | | | |
| | | W | D | H | W | D | H | W | H | | | | |
| | | | 90 | 32 | 34.5 | 74 | 18.5 | 17 | 82 | 17.5 | | | |

Loose seat cushions.

CAREFLEX



model GC4985



model GC4871

FEATURES

- Overlapping armrests and a sleek oval tube steel frame ensure years of use and comfort.
- Steel frames available in Black (BLK), Platinum (PLT), Toast (TOA), Tungsten (TUN), Cappuccino (T20), Mocha (J52), and Kalua (KAL). Please specify.
- The frame can be weighted and made with tamper proof fasteners for greater security in more challenging mental health spaces or correctional facilities.
- The standard armcap for models GC4871, GC4871HB, GC7601, GC7601-20, GC7605 and GC7605-20 is wood. Available in a variety of finishes. **Maple wood Only.**
- Models GC4871 and GC4871HB also have a wood side panel. Please Specify Finish for each.
- Optional Black (BLK), Platinum (PLT), Toast (TOA), Cappuccino (T20), Mocha (J52), and Kalua (KAL) self-skinned urethane armcaps are available - **Add \$48.00** list upcharge. *On models GC4871 and GC4871HB, the side panels will be covered in a coordinating colored vinyl textile.*
- For Globalcare textiles and finish options, visit the web site at www.thinkglobalcare.com.
- This product can be upholstered in standard global textiles when Healthcare compliance is not required
- Standard glide is plastic. For non-slip glides (models GC4985 & GC4987 only) **specify (NS)**.
- Slight sloping seat cushions and back cushions are modular for easy maintenance and replacement. Moisture Barrier (Seat Only) - **Add \$85.00** list upcharge per seat. For GC4871 and GC4871HB Bariatric models - **Add \$127.00** list upcharge
- For addition of a Fire Barrier Lining - **Add \$65.00** list upcharge per yard.
- Call Customer Service for **CAL133** approved textiles.
- Bariatric models GC4871 and GC4871HB have been specially designed in consultation with Healthcare specialists to meet the needs of larger individuals.

SUGGESTED APPLICATIONS

- Waiting Areas
- Resident Rooms
- Dining Rooms
- Patient Rooms
- Exam Rooms
- Guest Seating

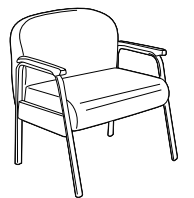

Bariatric Single Lounge Chair
 COM Yardage: 3.25
 Freight Class: 250
 Product Weight (lbs.): 78
 Cubic Feet Per Carton: 23

Armless Bariatric models are not available.
 • For users up to 750 lbs.

| COM | 2 | 3 | 4 | 5 | 6 | 7 | 8 | 9 | 10 | 11 | 12 | |
|--------------------|---|---|-----------------|----|------|-----------------|----|----|------|----|----|--------|
| | | | | | | | | | | | | \$1541 |
| OVERALL DIMENSIONS | | | SEAT DIMENSIONS | | | BACK DIMENSIONS | | | | | | |
| W | D | H | W | D | H | W | H | | | | | |
| | | | 30.5 | 27 | 34.5 | 28 | 20 | 18 | 28.5 | 15 | | |

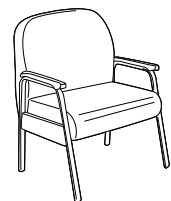

Bariatric High Back Single Lounge Chair
 COM Yardage: 3.50
 Freight Class: 250
 Product Weight (lbs.): 85
 Cubic Feet Per Carton: 28.25

Armless Bariatric models are not available.
 • For users up to 750 lbs.

| COM | 2 | 3 | 4 | 5 | 6 | 7 | 8 | 9 | 10 | 11 | 12 | |
|--------------------|---|---|-----------------|----|----|-----------------|----|----|------|----|----|--------|
| | | | | | | | | | | | | \$1632 |
| OVERALL DIMENSIONS | | | SEAT DIMENSIONS | | | BACK DIMENSIONS | | | | | | |
| W | D | H | W | D | H | W | H | | | | | |
| | | | 30.5 | 27 | 41 | 27.5 | 19 | 18 | 27.5 | 22 | | |

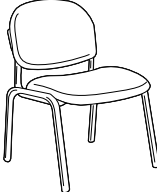

| DESCRIPTION | MODEL# | STANDARD FABRIC GRADES | | | | | | | | | | | |
|--|---------|------------------------------------|-----|-----|---------------------------------|------|------|-------------------------------|-----|------|-----|-----|-----|
| | | COM | 2 | 3 | 4 | 5 | 6 | 7 | 8 | 9 | 10 | 11 | 12 |
|  <p>Side Chair Four Leg Base, Ganging COM Yardage: 1 Freight Class: 300 Product Weight (lbs.): 23 Cubic Feet Per Carton: 13.25</p> | GC4886G | 451 | 474 | 493 | 521 | 561 | 576 | 611 | 676 | 709 | 770 | 855 | 959 |
| | | OVERALL DIMENSIONS W D H | | | SEAT DIMENSIONS W D H | | | BACK DIMENSIONS W H | | | | | |
| | | 23 | 25 | 33 | | 20.5 | 18.5 | 17 | | 20.5 | 16 | | |

Durable polypropylene outer back shell in Black only.
Built-in quick-connect ganging device joins chairs in a row when required.

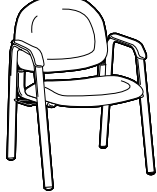
| DESCRIPTION | MODEL# | STANDARD FABRIC GRADES | | | | | | | | | | | |
|---|--------|------------------------------------|-------|-------|---------------------------------|-------|-------|-------------------------------|-------|-------|-------|-------|-------|
| | | COM | 2 | 3 | 4 | 5 | 6 | 7 | 8 | 9 | 10 | 11 | 12 |
|  <p>Armchair Four Leg Base, Urethane Armcaps COM Yardage: 1 Freight Class: 250 Product Weight (lbs.): 27 Cubic Feet Per Carton: 12.50</p> | GC4895 | \$431 | \$454 | \$473 | \$501 | \$541 | \$556 | \$591 | \$656 | \$689 | \$750 | \$835 | \$939 |
| | | OVERALL DIMENSIONS W D H | | | SEAT DIMENSIONS W D H | | | BACK DIMENSIONS W H | | | | | |
| | | 23.5 | 25 | 33 | | 20.5 | 19.5 | 17 | | 20.5 | 15 | | |

Durable polypropylene outer back shell in Black only.

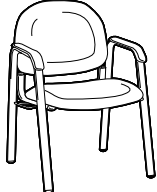
| DESCRIPTION | MODEL# | STANDARD FABRIC GRADES | | | | | | | | | | | |
|--|---------|------------------------------------|-------|-------|---------------------------------|-------|-------|-------------------------------|-------|-------|-------|-------|--------|
| | | COM | 2 | 3 | 4 | 5 | 6 | 7 | 8 | 9 | 10 | 11 | 12 |
|  <p>Armchair Four Leg Base, Urethane Armcaps, Ganging COM Yardage: 1 Freight Class: 300 Product Weight (lbs.): 29 Cubic Feet Per Carton: 17</p> | GC4895G | \$587 | \$610 | \$629 | \$657 | \$697 | \$712 | \$747 | \$812 | \$845 | \$906 | \$991 | \$1095 |
| | | OVERALL DIMENSIONS W D H | | | SEAT DIMENSIONS W D H | | | BACK DIMENSIONS W H | | | | | |
| | | 25 | 25 | 33 | | 20.5 | 19.5 | 17 | | 20.5 | 15 | | |

Durable polypropylene outer back shell in Black only.
Built-in quick-connect ganging device joins chairs in a row when required.

| DESCRIPTION | MODEL# | STANDARD FABRIC GRADES | | | | | | | | | | | |
|--|--------|------------------------------------|-------|-------|---------------------------------|-------|-------|-------------------------------|-------|-------|-------|-------|--------|
| | | COM | 2 | 3 | 4 | 5 | 6 | 7 | 8 | 9 | 10 | 11 | 12 |
|  <p>Side Chair Sled Base, Urethane Armcaps, Non-Ganging COM Yardage: 1 Freight Class: 250 Product Weight (lbs.): 29 Cubic Feet Per Carton: 11.25</p> | GC4897 | \$570 | \$593 | \$612 | \$640 | \$680 | \$695 | \$730 | \$795 | \$828 | \$889 | \$974 | \$1078 |
| | | OVERALL DIMENSIONS W D H | | | SEAT DIMENSIONS W D H | | | BACK DIMENSIONS W H | | | | | |
| | | 23.5 | 24.5 | 33 | | 20.5 | 18.5 | 17 | | 20.5 | 16 | | |

Durable polypropylene outer back shell in Black only.

| DESCRIPTION | MODEL# | STANDARD FABRIC GRADES | | | | | | | | | | | |
|--|---------|------------------------------------|-------|-------|---------------------------------|-------|-------|-------------------------------|-------|-------|-------|--------|--------|
| | | COM | 2 | 3 | 4 | 5 | 6 | 7 | 8 | 9 | 10 | 11 | 12 |
|  <p>Side Chair Sled Base, Urethane Armcaps, Ganging COM Yardage: 1 Freight Class: 250 Product Weight (lbs.): 29 Cubic Feet Per Carton: 13.25</p> | GC4897G | \$636 | \$659 | \$678 | \$706 | \$746 | \$761 | \$796 | \$861 | \$894 | \$955 | \$1040 | \$1144 |
| | | OVERALL DIMENSIONS W D H | | | SEAT DIMENSIONS W D H | | | BACK DIMENSIONS W H | | | | | |
| | | 25 | 24.5 | 33 | | 20.5 | 18.5 | 17 | | 20.5 | 16 | | |

Durable polypropylene outer back shell in Black only.
Built-in quick-connect ganging device joins chairs in a row when required.

CHAPTER



model GC3741

model GC3743

FEATURES

- Contemporary style lounge seating with wood or upholstered armcaps give this series a unique and functional appearance.
- Seat cushions are easily removable for cleaning and the open sealed frame below is great for housekeeping access.
- Molded plywood armcaps are available in a variety of finishes.
- Optional Black (BLK), Platinum (PLT) and Toast (TOA) vinyl coated armcaps are available at no upcharge (Must be specified at time of order placement).
- For Globalcare textiles and finish options, visit the web site at www.thinkglobalcare.com. **Available in Maple wood Only.**
- This product can be upholstered in standard global textiles when Healthcare compliance is not required.
- This product is shipped fully assembled.
- Standard glide is plastic. For **non-slip** glides **specify (NS)**. **Add \$21.00** list upcharge.
- Seat cushion is made of Ultracell foam for added comfort. Moisture Barrier (Seat Only) - **Add \$127.00** list upcharge per seat.
- For addition of a Fire Barrier Lining - **Add \$65.00** list upcharge per yard.
- Call Customer Service for **CAL133** approved textiles.

SUGGESTED APPLICATIONS

- Waiting Areas
- Lobbies
- Lounges

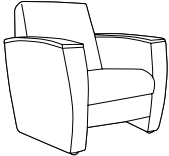
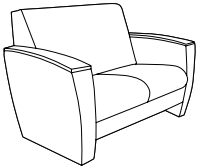
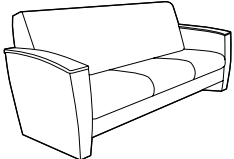
| DESCRIPTION | MODEL# | STANDARD FABRIC GRADES | | | | | | | | | | | |
|---|--------|------------------------|--------|--------|-----------------|--------|--------|-----------------|--------|--------|--------|--------|--------|
| | | COM | 2 | 3 | 4 | 5 | 6 | 7 | 8 | 9 | 10 | 11 | 12 |
|  Lounge Chair COM Yardage: 6.25 Freight Class: 250 Product Weight (lbs.): 90 Cubic Feet Per Carton: 28.50 Loose seat cushion. | GC3741 | \$1726 | \$1872 | \$1990 | \$2165 | \$2413 | \$2508 | \$2725 | \$3134 | \$3339 | \$3720 | \$4248 | \$4901 |
| | | OVERALL DIMENSIONS | | | SEAT DIMENSIONS | | | BACK DIMENSIONS | | | | | |
| | | W | D | H | W | D | H | W | H | | | | |
| | | | 33 | 32.5 | 35.5 | 21 | 19 | 16.5 | 22 | 19 | | | |
|  Two Seat Sofa COM Yardage: 8.75 Freight Class: 250 Product Weight (lbs.): 132 Cubic Feet Per Carton: 55.75 Loose seat cushions. | GC3742 | \$2274 | \$2478 | \$2643 | \$2888 | \$3236 | \$3368 | \$3672 | \$4245 | \$4532 | \$5064 | \$5804 | \$6718 |
| | | OVERALL DIMENSIONS | | | SEAT DIMENSIONS | | | BACK DIMENSIONS | | | | | |
| | | W | D | H | W | D | H | W | H | | | | |
| | | | 59.5 | 32.5 | 35.5 | 47.5 | 19 | 16.5 | 47.5 | 19 | | | |
|  Three Seat Sofa COM Yardage: 11.50 Freight Class: 250 Product Weight (lbs.): 150 Cubic Feet Per Carton: 74.75 Loose seat cushions. | GC3743 | \$2818 | \$3056 | \$3408 | \$3706 | \$4130 | \$4355 | \$4746 | \$5322 | \$5851 | \$6314 | \$7488 | \$8664 |
| | | OVERALL DIMENSIONS | | | SEAT DIMENSIONS | | | BACK DIMENSIONS | | | | | |
| | | W | D | H | W | D | H | W | H | | | | |
| | | | 83.5 | 32.5 | 35.5 | 71.5 | 19 | 16.5 | 71.5 | 19 | | | |

DESMOND



model GC4162

STANDARD FEATURES

- Clean lines and a contoured picture frame style back coordinate with any decor.
- Arms incorporate a firm grip extension to assist users in the entry and exist from the chair.
- Additional support rails on the legs ensure strength and durability.
- For Globalcare textiles and wood finish options, visit the web site at www.thinkglobalcare.com.
- **Available in European Beech Wood Only (Refer to finishes that end with an "M").**
- This product is shipped fully assembled.
- Front Casters available on model ending with FC.
- Standard glide is plastic. For Non-slip glides specify (NS) - **Add \$21.00** list upcharge.
- Seat is made from Ultracell foam for added comfort. Moisture Barrier (Seat Only) - **Add \$85.00** list upcharge.
- For addition of a Fire Barrier Lining - **Add \$65.00** list upcharge per yard.
- Call Customer Service for **CAL133** approved textiles.

SUGGESTED APPLICATIONS

- Dining Rooms

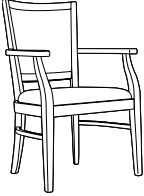
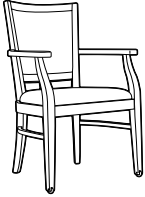
| DESCRIPTION | MODEL# | STANDARD FABRIC GRADES | | | | | | | | | | | |
|---|----------|------------------------|--------|--------|-----------------|--------|--------|-----------------|--------|--------|--------|--------|--------|
| | | COM | 2 | 3 | 4 | 5 | 6 | 7 | 8 | 9 | 10 | 11 | 12 |
|  <p>Armchair COM Yardage: 1.25 Freight Class: 300 Product Weight (lbs.): 24 Cubic Feet Per Carton: 14.50</p> | GC4162 | \$1193 | \$1220 | \$1306 | \$1339 | \$1390 | \$1410 | \$1452 | \$1534 | \$1575 | \$1651 | \$1756 | \$1886 |
| | | OVERALL DIMENSIONS | | | SEAT DIMENSIONS | | | BACK DIMENSIONS | | | | | |
| | | W | D | H | W | D | H | W | H | | | | |
| | | | | | | | | | | | | | |
|  <p>Armchair Front Casters COM Yardage: 1.25 Freight Class: 300 Product Weight (lbs.): 24 Cubic Feet Per Carton: 14.50</p> | GC4162FC | \$1288 | \$1316 | \$1409 | \$1445 | \$1497 | \$1517 | \$1563 | \$1648 | \$1692 | \$1771 | \$1881 | \$2018 |
| | | OVERALL DIMENSIONS | | | SEAT DIMENSIONS | | | BACK DIMENSIONS | | | | | |
| | | W | D | H | W | D | H | W | H | | | | |
| | | | | | | | | | | | | | |

DOCTOR BUDDY



model GC1104

STANDARD FEATURES

- Doctor Buddy is the perfect stool to provide comfort when performing office tasks or as an examination or feeding stool when caring for others.
- Swivel stool, seat upholstered in Vinyl or fabric with Ultracell foam cushion.
- Moisture resistant protection on underside of seat pan.
- 16" seat diameter with Black five-legged injection-molded base.
- **C65 casters are standard.**
- For hard surface flooring casters, specify **C65R** - **Add \$47.00** list upcharge.

- For Globalcare textiles and finish options, visit the web site at www.thinkglobalcare.com.
- This product can be upholstered in standard Global textiles only if Healthcare compliance is not required.

SUGGESTED APPLICATIONS

- Exam Rooms
- Patient Rooms

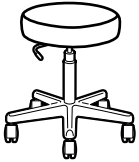
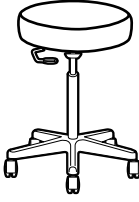
| DESCRIPTION | MODEL# | STANDARD FABRIC GRADES | | | | | | | | | | | |
|---|--------|---|-------|-------|---|-------|-------|---|-------|-------|-------|-------|-------|
| | | COM | 2 | 3 | 4 | 5 | 6 | 7 | 8 | 9 | 10 | 11 | 12 |
|  <p>Swivel Stool 5" Pneumatic, 20" Base COM Yardage: .75 Freight Class: 125 Product Weight (lbs.): 15 Cubic Feet Per Carton: 2.50</p> | GC1104 | \$336 | \$336 | \$351 | \$371 | \$401 | \$415 | \$437 | \$487 | \$510 | \$557 | \$620 | \$698 |
| | | <p>OVERALL DIMENSIONS</p> <p>W D H</p> <p>20 20 18.5</p> | | | <p>SEAT DIMENSIONS</p> <p>W D H</p> <p>16 -- 16.5 - 21.5</p> | | | <p>BACK DIMENSIONS</p> <p>W H</p> <p>-- --</p> | | | | | |
| For hardsurface flooring casters - Add \$47.00 list upcharge. | | | | | | | | | | | | | |
|  <p>Swivel Stool 10" Pneumatic, 22" Base COM Yardage: .75 Freight Class: 125 Product Weight (lbs.): 18 Cubic Feet Per Carton: 2.90</p> | GC1109 | \$357 | \$357 | \$371 | \$392 | \$422 | \$436 | \$458 | \$508 | \$531 | \$578 | \$641 | \$718 |
| | | <p>OVERALL DIMENSIONS</p> <p>W D H</p> <p>22 22 27.5</p> | | | <p>SEAT DIMENSIONS</p> <p>W D H</p> <p>16 -- 22.5 - 32.5</p> | | | <p>BACK DIMENSIONS</p> <p>W H</p> <p>-- --</p> | | | | | |
| For hardsurface flooring casters - Add \$47.00 list upcharge. | | | | | | | | | | | | | |

FROLICK, CURTSY & SPLASH



model GC3001

model GC3018

model GC3011

Three different back constructions



Separate panel piece closes the lower back to conceal the support bracket. Offered in **Frolick** series on select models.

Single piece back with a pullover style upholstery cover and support bracket fastened on the outer back. Offered in **Curtsy** series and on select **Frolick** models.

Two piece back covering the back support brackets when fastened in place. Offered in **Splash** series.

FEATURES



- Frolick, Splash and Curtsy are Multi-Purpose stacking chairs that share generous width between the arms, great comfort, and a frame built for greater strength and stability. Each series offers a different back design with special features to best address the application and infection control practices.
- Standard size models offer 19" seat width with 21.5" clearance between the armrests. Bariatric size models offer 31.5" seat width with 33.5" clearance between the armrests.
- Heavy duty round, tubular gusseted frames. Available in Black (**BLK**), Platinum (**PLT**), Toast (**TOA**), Tungsten (**TUN**), Cappuccino (**T20**), Mocha (**J52**), and Kalua (**KAL**). Please specify.
- Active weight capacity is up to 300 lbs. for standard models, and 500 lbs. for Bariatric models.
- Wallsaver rear legs eliminate accidental damage to walls.
- Armrests are fiberglass reinforced Nylon and have a flat profile. Fully extended to front of seat edge to assist in entry and exit from the chair.
- Armrests are standard in Black (**BLK**). Also available in Toast (**TOA**) and Platinum (**PLT**). Please Specify - **Add \$24.00** list upcharge.
- Protective Platinum (**PLT**) color seat shroud is standard on all models (except Bariatric models GC3003 and GC3023).
- For a completely sealed seat pan underside with no seat shroud used, please add (-S) to the model number. For standard models - **Add \$42.00** list upcharge. For Bariatric models - **Add \$59.00** list upcharge.
- Comfortable 1.5" high density and high resilient Ultracell Biofoam with waterfall front on the seat, ensures maximum comfort.
- Back descriptions are noted with each model.
- As an option, seams can be sealed to prevent

penetration of fluids through the stitching. Please contact customer service for more information.

- Moisture Barrier (Seat Only) - **Add \$85.00** list upcharge per seat. For Bariatric models - **Add \$131.00** list upcharge per seat.
- For addition of a Fire Barrier Lining - **Add \$65.00** list upcharge per yard.
- Standard glides (on all models) and front leg caps (on armless models) are standard in Platinum (**PLT**) on Toast (**TOA**), Platinum (**PLT**) and Tungsten (**TUN**) frames. Black (**BLK**) frames are standard with Black (**BLK**) glides and front leg caps on armless models.
- Four legged standard size models stack 5 high without dolly and 8 high on GC3010 dolly. **Four legged Bariatric models stack 2 high only** - No dolly available. All Sled Base models do not stack.
- For ganging brackets, see Model 2180 in the Global Seating List Price Book.
- For Globalcare textile options, visit the web site at www.thinkglobalcare.com.
- This product can be upholstered in standard Global textiles only if Healthcare compliance is not required.
- Call Customer Service for **CAL133** approved textiles.

SUGGESTED APPLICATIONS

- Waiting Areas
- Resident Rooms
- Dining Rooms
- Patient Rooms
- Exam Rooms
- Guest Seating

| DESCRIPTION | MODEL# | STANDARD FABRIC GRADES | | | | | | | | | | | |
|---|--------|------------------------|-------|-------|-----------------|-------|-------|-----------------|-------|-------|-------|--------|--------|
| | | COM | 2 | 3 | 4 | 5 | 6 | 7 | 8 | 9 | 10 | 11 | 12 |
|  <p>Frolick Stacking Armchair 4 Leg Base, Rectangular back with concealed attachment COM Yardage: 1.25 Freight Class: 300 Product Weight (lbs.): 24 Cubic Feet Per Carton: 20</p> <p>Stacks 5 high without dolly.</p> | GC3001 | \$521 | \$548 | \$571 | \$605 | \$652 | \$670 | \$712 | \$790 | \$829 | \$902 | \$1003 | \$1128 |
| | | OVERALL DIMENSIONS | | | SEAT DIMENSIONS | | | BACK DIMENSIONS | | | | | |
| | | W | D | H | W | D | H | W | H | | | | |
| | | 25 | 24.5 | 36 | 19 | 18 | 18.5 | 19.5 | 17 | | | | |
|  <p>Frolick Stacking Chair Armless, 4 Leg Base, Rectangular back with concealed attachment COM Yardage: 1.25 Freight Class: 300 Product Weight (lbs.): 22 Cubic Feet Per Carton: 20</p> <p>Stacks 5 high without dolly.</p> | GC3002 | \$498 | \$525 | \$548 | \$582 | \$629 | \$647 | \$689 | \$767 | \$806 | \$879 | \$980 | \$1105 |
| | | OVERALL DIMENSIONS | | | SEAT DIMENSIONS | | | BACK DIMENSIONS | | | | | |
| | | W | D | H | W | D | H | W | H | | | | |
| | | 21 | 24.5 | 36 | 19 | 18 | 18.5 | 19.5 | 17 | | | | |

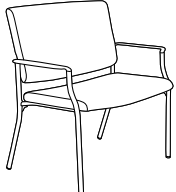
| DESCRIPTION | MODEL# | STANDARD FABRIC GRADES | | | | | | | | | | | |
|---|--------|------------------------|--------|--------|-----------------|--------|--------|-----------------|--------|--------|--------|--------|--------|
| | | COM | 2 | 3 | 4 | 5 | 6 | 7 | 8 | 9 | 10 | 11 | 12 |
|  <p>Frolick Bariatric Stacking Armchair 4 Leg Base, Rectangular back with concealed attachment COM Yardage: 2.25 Freight Class: 300 Product Weight (lbs.): 42 Cubic Feet Per Carton: 26.50</p> <p>Stacks 2 high. • For users up to 500 lbs.</p> | GC3003 | \$954 | \$1004 | \$1045 | \$1105 | \$1191 | \$1223 | \$1298 | \$1439 | \$1510 | \$1641 | \$1823 | \$2048 |
| | | OVERALL DIMENSIONS | | | SEAT DIMENSIONS | | | BACK DIMENSIONS | | | | | |
| | | W | D | H | W | D | H | W | H | | | | |
| | | 37 | 24.5 | 36 | 31.5 | 18 | 18.5 | 32 | 18.5 | | | | |

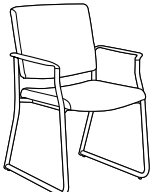
|  <p>Frolick Armchair Sled Base, Rectangular back with concealed attachment COM Yardage: 1.25 Freight Class: 300 Product Weight (lbs.): 32 Cubic Feet Per Carton: 17</p> <p>Does not stack.</p> | GC3021 | COM | 2 | 3 | 4 | 5 | 6 | 7 | 8 | 9 | 10 | 11 | 12 |
|--|--------|--------------------|-------|-------|-----------------|-------|-------|-----------------|-------|-------|-------|--------|--------|
| | | \$540 | \$567 | \$590 | \$624 | \$671 | \$689 | \$731 | \$809 | \$848 | \$921 | \$1022 | \$1147 |
| | | OVERALL DIMENSIONS | | | SEAT DIMENSIONS | | | BACK DIMENSIONS | | | | | |
| | | W | D | H | W | D | H | W | H | | | | |
| | | 25 | 24.5 | 36 | 18 | 17 | 18.5 | 18.75 | 18 | | | | |

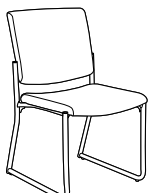
|  <p>Frolick Armless Chair Sled Base, Rectangular back with concealed attachment COM Yardage: 1.25 Freight Class: 250 Product Weight (lbs.): 30 Cubic Feet Per Carton: 13.75</p> <p>Does not stack.</p> | GC3022 | COM | 2 | 3 | 4 | 5 | 6 | 7 | 8 | 9 | 10 | 11 | 12 |
|---|--------|--------------------|-------|-------|-----------------|-------|-------|-----------------|-------|-------|-------|-------|--------|
| | | \$517 | \$544 | \$567 | \$601 | \$648 | \$666 | \$708 | \$786 | \$825 | \$898 | \$999 | \$1124 |
| | | OVERALL DIMENSIONS | | | SEAT DIMENSIONS | | | BACK DIMENSIONS | | | | | |
| | | W | D | H | W | D | H | W | H | | | | |
| | | 21 | 24.5 | 36 | 19 | 18 | 18.5 | 19.5 | 17 | | | | |

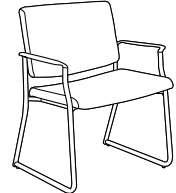
|  <p>Frolick Bariatric Armchair Sled Base, Rectangular back with concealed attachment COM Yardage: 2.25 Freight Class: 300 Product Weight (lbs.): 47 Cubic Feet Per Carton: 26.50</p> <p>Does not stack. • For users up to 500 lbs.</p> | GC3023 | COM | 2 | 3 | 4 | 5 | 6 | 7 | 8 | 9 | 10 | 11 | 12 |
|--|--------|--------------------|--------|--------|-----------------|--------|--------|-----------------|--------|--------|--------|--------|--------|
| | | \$1015 | \$1065 | \$1106 | \$1166 | \$1252 | \$1284 | \$1359 | \$1500 | \$1571 | \$1702 | \$1884 | \$2109 |
| | | OVERALL DIMENSIONS | | | SEAT DIMENSIONS | | | BACK DIMENSIONS | | | | | |
| | | W | D | H | W | D | H | W | H | | | | |
| | | 37 | 24.5 | 36.5 | 31.5 | 18 | 18.5 | 32 | 18.5 | | | | |

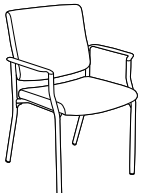
|  <p>Frolick Stacking Armchair 4 Leg Base, Rectangular back COM Yardage: 1.25 Freight Class: 300 Product Weight (lbs.): 24 Cubic Feet Per Carton: 20</p> <p>Single piece back with pullover style upholstery cover with exposed support brackets on the outer back. Stacks 5 high without dolly.</p> | GC3031 | COM | 2 | 3 | 4 | 5 | 6 | 7 | 8 | 9 | 10 | 11 | 12 |
|--|--------|--------------------|-------|-------|-----------------|-------|-------|-----------------|-------|-------|-------|--------|--------|
| | | \$521 | \$548 | \$571 | \$605 | \$652 | \$670 | \$712 | \$790 | \$829 | \$902 | \$1003 | \$1128 |
| | | OVERALL DIMENSIONS | | | SEAT DIMENSIONS | | | BACK DIMENSIONS | | | | | |
| | | W | D | H | W | D | H | W | H | | | | |
| | | 25 | 24.5 | 36 | 19 | 18 | 18.5 | 19.5 | 17 | | | | |

SEATING

FROLICK, CURTSY, SPLASH F

| DESCRIPTION | MODEL# | STANDARD FABRIC GRADES | | | | | | | | | | | |
|---|--------|------------------------|-------|-------|-----------------|-------|-------|-----------------|-------|-------|-------|-------|--------|
| | | COM | 2 | 3 | 4 | 5 | 6 | 7 | 8 | 9 | 10 | 11 | 12 |
|  Frolick Stacking Chair Armless, 4 Leg Base, Rectangular back COM Yardage: 1.25 Freight Class: 300 Product Weight (lbs.): 22 Cubic Feet Per Carton: 20 | GC3032 | \$498 | \$525 | \$548 | \$582 | \$629 | \$647 | \$689 | \$767 | \$806 | \$879 | \$980 | \$1105 |
| | | OVERALL DIMENSIONS | | | SEAT DIMENSIONS | | | BACK DIMENSIONS | | | | | |
| | | W | D | H | W | D | H | W | H | | | | |
| | | 21 | 24.5 | 36 | 19 | 18 | 18.5 | 19.5 | 17 | | | | |

Single piece back with pullover style upholstery cover with **exposed support brackets** on the outer back. Stacks 5 high without dolly.

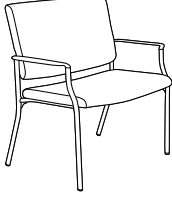
| DESCRIPTION | MODEL# | STANDARD FABRIC GRADES | | | | | | | | | | | |
|--|--------|------------------------|--------|--------|-----------------|--------|--------|-----------------|--------|--------|--------|--------|--------|
| | | COM | 2 | 3 | 4 | 5 | 6 | 7 | 8 | 9 | 10 | 11 | 12 |
|  Frolick Bariatric Stacking Armchair 4 Leg Base, Rectangular back COM Yardage: 2.25 Freight Class: 300 Product Weight (lbs.): 42 Cubic Feet Per Carton: 26.50 | GC3033 | \$954 | \$1004 | \$1045 | \$1105 | \$1191 | \$1223 | \$1298 | \$1439 | \$1510 | \$1641 | \$1823 | \$2048 |
| | | OVERALL DIMENSIONS | | | SEAT DIMENSIONS | | | BACK DIMENSIONS | | | | | |
| | | W | D | H | W | D | H | W | H | | | | |
| | | 37 | 24.5 | 36.5 | 31.5 | 18 | 18.5 | 32 | 18.5 | | | | |

Single piece back with pullover style upholstery cover with **exposed support brackets** on the outer back.
 • For users up to 500 lbs.
 Stacks 2 high.

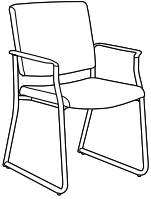
| DESCRIPTION | MODEL# | STANDARD FABRIC GRADES | | | | | | | | | | | |
|--|--------|------------------------|-------|-------|-----------------|-------|-------|-----------------|-------|-------|-------|--------|--------|
| | | COM | 2 | 3 | 4 | 5 | 6 | 7 | 8 | 9 | 10 | 11 | 12 |
|  Frolick Armchair Sled Base, Rectangular back COM Yardage: 1.25 Freight Class: 300 Product Weight (lbs.): 32 Cubic Feet Per Carton: 17 | GC3034 | \$540 | \$567 | \$590 | \$624 | \$671 | \$689 | \$731 | \$809 | \$848 | \$921 | \$1022 | \$1147 |
| | | OVERALL DIMENSIONS | | | SEAT DIMENSIONS | | | BACK DIMENSIONS | | | | | |
| | | W | D | H | W | D | H | W | H | | | | |
| | | 25 | 24.5 | 36 | 18 | 17 | 18.5 | 18.75 | 18 | | | | |

Single piece back with pullover style upholstery cover with **exposed support brackets** on the outer back.
Does not stack.

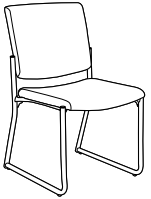
| DESCRIPTION | MODEL# | STANDARD FABRIC GRADES | | | | | | | | | | | |
|---|--------|------------------------|-------|-------|-----------------|-------|-------|-----------------|-------|-------|-------|-------|--------|
| | | COM | 2 | 3 | 4 | 5 | 6 | 7 | 8 | 9 | 10 | 11 | 12 |
|  Frolick Armless Chair Sled Base, Rectangular back COM Yardage: 1.25 Freight Class: 250 Product Weight (lbs.): 30 Cubic Feet Per Carton: 13.75 | GC3035 | \$517 | \$544 | \$567 | \$601 | \$648 | \$666 | \$708 | \$786 | \$825 | \$898 | \$999 | \$1124 |
| | | OVERALL DIMENSIONS | | | SEAT DIMENSIONS | | | BACK DIMENSIONS | | | | | |
| | | W | D | H | W | D | H | W | H | | | | |
| | | 21 | 24.5 | 36 | 19 | 18 | 18.5 | 19.5 | 17 | | | | |

Single piece back with pullover style upholstery cover with **exposed support brackets** on the outer back.
Does not stack.

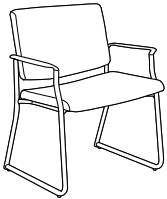
| DESCRIPTION | MODEL# | STANDARD FABRIC GRADES | | | | | | | | | | | |
|--|--------|------------------------|--------|--------|-----------------|--------|--------|-----------------|--------|--------|--------|--------|--------|
| | | COM | 2 | 3 | 4 | 5 | 6 | 7 | 8 | 9 | 10 | 11 | 12 |
|  Frolick Bariatric Armchair Sled Base, Rectangular back COM Yardage: 2.25 Freight Class: 300 Product Weight (lbs.): 47 Cubic Feet Per Carton: 26.50 | GC3036 | \$1015 | \$1065 | \$1106 | \$1166 | \$1252 | \$1284 | \$1359 | \$1500 | \$1571 | \$1702 | \$1884 | \$2109 |
| | | OVERALL DIMENSIONS | | | SEAT DIMENSIONS | | | BACK DIMENSIONS | | | | | |
| | | W | D | H | W | D | H | W | H | | | | |
| | | 37 | 24.5 | 36.5 | 31.5 | 18 | 18.5 | 32 | 18.5 | | | | |

Single piece back with pullover style upholstery cover with **exposed support brackets** on the outer back.
 • For users up to 500 lbs.
Does not stack.

| DESCRIPTION | MODEL# | STANDARD FABRIC GRADES | | | | | | | | | | | |
|---|--------|------------------------|-------|-------|-----------------|-------|-------|-----------------|-------|-------|-------|--------|--------|
| | | COM | 2 | 3 | 4 | 5 | 6 | 7 | 8 | 9 | 10 | 11 | 12 |
|  <p>Curtsy Stacking Armchair 4 Leg Base, Arched Back COM Yardage: 1.25 Freight Class: 300 Product Weight (lbs.): 24 Cubic Feet Per Carton: 20</p> | GC3008 | \$521 | \$548 | \$571 | \$605 | \$652 | \$670 | \$712 | \$790 | \$829 | \$902 | \$1003 | \$1128 |
| | | OVERALL DIMENSIONS | | | SEAT DIMENSIONS | | | BACK DIMENSIONS | | | | | |
| | | W | D | H | W | D | H | W | H | | | | |
| | | 25 | 24 | 34.25 | 19 | 18 | 18.5 | 19 | 16.5 | | | | |

Single piece back with pullover style upholstery cover with **exposed support brackets** on the outer back. Stacks 5 high without dolly.

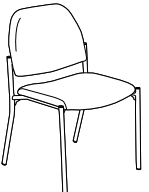
| | | | | | | | | | | | | | |
|---|--------|--------------------|-------|-------|-----------------|-------|-------|-----------------|-------|-------|-------|-------|--------|
|  <p>Curtsy Stacking Chair Armless, 4 Leg Base, Arched back COM Yardage: 1.25 Freight Class: 300 Product Weight (lbs.): 20 Cubic Feet Per Carton: 20</p> | GC3009 | COM | 2 | 3 | 4 | 5 | 6 | 7 | 8 | 9 | 10 | 11 | 12 |
| | | \$498 | \$525 | \$548 | \$582 | \$629 | \$647 | \$689 | \$767 | \$806 | \$879 | \$980 | \$1105 |
| | | OVERALL DIMENSIONS | | | SEAT DIMENSIONS | | | BACK DIMENSIONS | | | | | |
| | | W | D | H | W | D | H | W | H | | | | |
| | | 21 | 24 | 34.25 | 19 | 18 | 18.5 | 19 | 16.5 | | | | |

Single piece back with pullover style upholstery cover with **exposed support brackets** on the outer back. Stacks 5 high without dolly.

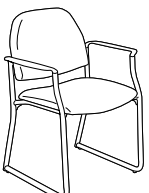
| | | | | | | | | | | | | | |
|---|--------|--------------------|-------|-------|-----------------|-------|-------|-----------------|-------|-------|-------|--------|--------|
|  <p>Curtsy Armchair Sled Base, Arched Back COM Yardage: 1.25 Freight Class: 250 Product Weight (lbs.): 28 Cubic Feet Per Carton: 13.25</p> | GC3018 | COM | 2 | 3 | 4 | 5 | 6 | 7 | 8 | 9 | 10 | 11 | 12 |
| | | \$540 | \$567 | \$590 | \$624 | \$671 | \$689 | \$731 | \$809 | \$848 | \$921 | \$1022 | \$1147 |
| | | OVERALL DIMENSIONS | | | SEAT DIMENSIONS | | | BACK DIMENSIONS | | | | | |
| | | W | D | H | W | D | H | W | H | | | | |
| | | 25 | 24 | 34.25 | 19 | 18 | 18.5 | 19 | 16.5 | | | | |

Single piece back with pullover style upholstery cover with **exposed support brackets** on the outer back. **Does not stack.**

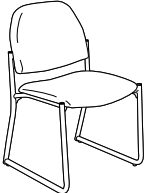
| | | | | | | | | | | | | | |
|---|--------|--------------------|-------|-------|-----------------|-------|-------|-----------------|-------|-------|-------|-------|--------|
|  <p>Curtsy Armless Chair Sled Base, Arched Back COM Yardage: 1.25 Freight Class: 300 Product Weight (lbs.): 24 Cubic Feet Per Carton: 13.25</p> | GC3019 | COM | 2 | 3 | 4 | 5 | 6 | 7 | 8 | 9 | 10 | 11 | 12 |
| | | \$517 | \$544 | \$567 | \$601 | \$648 | \$666 | \$708 | \$786 | \$825 | \$898 | \$999 | \$1124 |
| | | OVERALL DIMENSIONS | | | SEAT DIMENSIONS | | | BACK DIMENSIONS | | | | | |
| | | W | D | H | W | D | H | W | H | | | | |
| | | 21 | 24 | 34.25 | 19 | 18 | 18.5 | 19 | 16.5 | | | | |

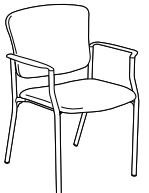

Single piece back with pullover style upholstery cover with **exposed support brackets** on the outer back. **Does not stack.**

| | | | | | | | | | | | | | |
|---|--------|--------------------|-------|-------|-----------------|-------|-------|-----------------|-------|-------|-------|--------|--------|
|  <p>Splash Stacking Armchair 4 Leg Base, Fan back with concealed attachment COM Yardage: 1.25 Freight Class: 300 Product Weight (lbs.): 25.33 Cubic Feet Per Carton: 20</p> | GC3011 | COM | 2 | 3 | 4 | 5 | 6 | 7 | 8 | 9 | 10 | 11 | 12 |
| | | \$521 | \$548 | \$571 | \$605 | \$652 | \$670 | \$712 | \$790 | \$829 | \$902 | \$1003 | \$1128 |
| | | OVERALL DIMENSIONS | | | SEAT DIMENSIONS | | | BACK DIMENSIONS | | | | | |
| | | W | D | H | W | D | H | W | H | | | | |
| | | 25 | 24.25 | 35.5 | 19.5 | 18.5 | 18.5 | 20 | 17.5 | | | | |

Stacks 5 high without dolly.

SEATING

FROLICK, CURTSY, SPLASH F

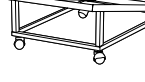
| DESCRIPTION | MODEL# | STANDARD FABRIC GRADES | | | | | | | | | | | |
|---|--------|------------------------|-------|-------|-----------------|-------|-------|-----------------|-------|-------|-------|--------|--------|
| | | COM | 2 | 3 | 4 | 5 | 6 | 7 | 8 | 9 | 10 | 11 | 12 |
|  <p>Splash Stacking Chair Armless, 4 Leg Base, Fan back with concealed attachment COM Yardage: 1.25 Freight Class: 300 Product Weight (lbs.): 22.33 Cubic Feet Per Carton: 20</p> | GC3012 | \$498 | \$525 | \$548 | \$582 | \$629 | \$647 | \$689 | \$767 | \$806 | \$879 | \$980 | \$1105 |
| | | OVERALL DIMENSIONS | | | SEAT DIMENSIONS | | | BACK DIMENSIONS | | | | | |
| | | W | D | H | W | D | H | W | H | | | | |
| | | | 21 | 24.25 | 35.5 | 19.5 | 18.5 | 18.5 | 20 | 17.5 | | | |
|  <p>Splash Armchair Sled Base, Fan back with concealed attachment COM Yardage: 1.25 Freight Class: 250 Product Weight (lbs.): 34 Cubic Feet Per Carton: 17</p> <p>Does not stack.</p> | GC3013 | \$540 | \$567 | \$590 | \$624 | \$671 | \$689 | \$731 | \$809 | \$848 | \$921 | \$1022 | \$1147 |
| | | OVERALL DIMENSIONS | | | SEAT DIMENSIONS | | | BACK DIMENSIONS | | | | | |
| | | W | D | H | W | D | H | W | H | | | | |
| | | | 25 | 24.25 | 35.5 | 19.5 | 18.5 | 18.5 | 20 | 17.5 | | | |
|  <p>Splash Side Chair Sled Base, Fan back with concealed attachment COM Yardage: 1.25 Freight Class: 250 Product Weight (lbs.): 32 Cubic Feet Per Carton: 13.75</p> <p>Does not stack.</p> | GC3014 | \$517 | \$544 | \$567 | \$601 | \$648 | \$666 | \$708 | \$786 | \$825 | \$898 | \$999 | \$1124 |
| | | OVERALL DIMENSIONS | | | SEAT DIMENSIONS | | | BACK DIMENSIONS | | | | | |
| | | W | D | H | W | D | H | W | H | | | | |
| | | | 21 | 24.25 | 35.5 | 19.5 | 18.5 | 18.5 | 20 | 17.5 | | | |
|  <p>Dolly for Frolick, Curtsy and Splash standard size, four leg chairs COM Yardage: -- Freight Class: 150 Product Weight (lbs.): 16 Cubic Feet Per Carton: 3.80</p> <p>Allows chairs to stack up to 8 high.</p> | GC3010 | LIST PRICE | | | | | | | | | | | |
| | | \$255 | | | | | | | | | | | |
| | | OVERALL DIMENSIONS | | | SEAT DIMENSIONS | | | BACK DIMENSIONS | | | | | |
| W | D | H | W | D | H | W | H | | | | | | |
| | | | 23.25 | 24.75 | 12.25 | | | | | | | | |

GC-BELONG



model GC4231HB

model GC4231HB

FEATURES

- The GC - Belong Series was developed for active and transient spaces and environments with rigorous demands.
- Elliptical metal tube frame. Available in Black (BLK), Platinum (PLT), Toast (TOA), Tungsten (TUN), Cappuccino (T20), Mocha (J52), and Kalua (KAL). Please specify.
- Self-skinned urethane armcaps are available in Black (BLK), Platinum (PLT), Toast (TOA), Cappuccino (T20), Mocha (J52), and Kalua (KAL). Please Specify. Wood armcaps are also available in all Globalcare wood finishes. Please specify. Refer to individual models for upcharge.
- The frame can be weighted and made with tamper proof fasteners for greater security in more challenging mental health spaces or correctional facilities.
- The seat and back are removable and field replaceable.
- All seats are standard with High Density Ultracell foam.
- All Seat Frames feature a wallsaver design to prevent back contact with wall. **Note:** In order to allow full flex of the back on models GC4242, GC4242HB, GC4243 and GC4243HB, a 10.5" wall clearance is required. Ottomans and Benches do not have wallsaver legs.
- Standard seat height on all models is 18.5"
- Select models are offered with casters on the rear legs. These casters allow for ease of movement in support of housekeeping efforts or repositioning seating within a space. **They are not intended for patient transfer.**
- Cleanout space is provided between the seat and back cushions for easier housekeeping.
- **Left and Right Position Reference** is determined based on being seated in the bench.
- Standard with Black glides. Non-marking glides also available. Specify **NM** - No Upcharge.

- Flex Back models feature a torsion control mechanism which allows the back to move in a soothing rocking motion.
- Complementary tables are offered as part of this series in either high pressure or thermally fused laminate tops.
- Moisture Barrier (Seat Only) - **Add \$85.00** list upcharge per seat. For Bariatric models - **Add \$131.00** list upcharge per seat.
- As an option, seams can be sealed to prevent penetration of fluids through the stitching. Contact Customer Service for approved textiles.
 - Low Back Models - **Add \$73.00** list upcharge per seat
 - Low Back Bariatric Models - **Add \$79.00** list upcharge per seat
 - High Back Models - **Add \$80.00** list upcharge per seat
 - High Back Bariatric Models - **Add \$86.00** list upcharge per seat
 - Split-Back Models - **Add \$119.00** list upcharge per seat
 - Ottoman - **Add \$25.00** list upcharge
 - Benches - **Add \$35.00** list upcharge per seat.
- Active weight capacity is 500 lbs. per seat position and 750 lbs for Bariatric Seating.
- For Globalcare textiles and wood finish options, visit the web site at www.thinkglobalcare.com.
- This product can be upholstered in standard Global textiles if healthcare compliance is not required.
- For addition of a Fire Barrier Lining - **Add \$65.00** list upcharge per yard.
- Call Customer Service for **CAL133** approved textiles.

SUGGESTED APPLICATIONS

- Waiting Areas
- Guest Seating
- Lobbies

BENCHES & BRIDGES

- Units with links can only gang with a bridge. They CANNOT gang directly with another link unit. (Link units have side brackets.)
- Available in One, Two or Three seat models.
- A bridge unit suspends between 2 other units using their links. A Bridge is NOT freestanding. (A Bridge does not have legs.)
- Benches have no front or back facing distinction so models with links can be reversed.
- All bridge models can be ganged to seat units with link.

TABLES

- Table heights are 16"
- 1" thick tops are available in thermally fused laminate (L) and high pressure laminate (H). Please select the appropriate model number for the finish you prefer.
- 3mm edging color coordinated with laminate finish is standard for all tops. Finish MUST BE specified at the time of order.
- Refer to the following lists when selecting a finish color. MUST Specify both a Top Color and Leg Finish when ordering.

Thermally Fused Laminate (L)

- (ACJ) Absolute Acajou
- (ASN) Asian Night
- (AWC) Avant Cherry
- (AWH) Avant Honey
- (BRC) Brushed Cobalt
- (CSJ) Constellation Java
- (DES) Dark Espresso
- (HGT) Hayden Grey
- (QTM) Quartered Mahogany
- (SKC) Shaker Cherry
- (TFW) Tiger Fruitwood
- (TMA) Tiger Mahogany
- (TMP) Tiger Maple
- (TWL) Tiger Walnut
- (WHT) White
- (WHC) White Chocolate
- (WCR) Winter Cherry

High Pressure Laminate (H)

- (W357) Avant Cherry
- (W356) Avant Honey
- (BCH) Brushed Cobalt
- (CJH) Constellation Java
- (W142) Dark Espresso
- (W313) Quartered Mahogany
- (SKB) Shaker Cherry
- (W821) Tiger Fruitwood
- (W822) Tiger Mahogany
- (W820) Tiger Maple
- (W819) Tiger Walnut
- (S645) White
- (W149) Winter Cherry
- (CMB) Clear Maple
- (EMB) Empire Mahogany

LOW BACK

| | | | | | | | |
|--|-------------|-------------|-------------|-------------|-------------|-------------|-------------|
| | GC4230 | GC4231 | GC4232 | GC4234 | GC4233 | GC4235 | GC4236 |
| Freestanding units | | | | | | | |
| Ganging units with link on Left side | GC4230L | GC4231L | GC4232L | GC4234L | GC4233L | GC4235L | GC4236L |
| Ganging units with link on Right side | GC4230R | GC4231R | GC4232R | GC4234R | GC4233R | GC4235R | GC4236R |
| Ganging units with links on Both sides | GC4230B | GC4231B | GC4232B | GC4234B | GC4233B | GC4235B | GC4236B |

HIGH BACK

| | | | | | | | |
|--|---------------|---------------|---------------|---------------|---------------|---------------|---------------|
| | GC4230HB | GC4231HB | GC4232HB | GC4234HB | GC4233HB | GC4235HB | GC4236HB |
| Freestanding units | | | | | | | |
| Ganging units with link on Left side | GC4230HBL | GC4231HBL | GC4232HBL | GC4234HBL | GC4233HBL | GC4235HBL | GC4236HBL |
| Ganging units with link on Right side | GC4230HBR | GC4231HBR | GC4232HBR | GC4234HBR | GC4233HBR | GC4235HBR | GC4236HBR |
| Ganging units with links on Both sides | GC4230HBB | GC4231HBB | GC4232HBB | GC4234HBB | GC4233HBB | GC4235HBB | GC4236HBB |

Non ganging units with casters

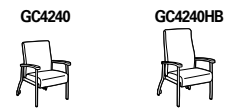

Ganging Bariatric units with link on Both side



Non ganging Bariatric units



Non ganging Flexback units



Non ganging Split Back units



Ganging Bariatric units with link on Left side



Non ganging Flexback units with casters



Non ganging Split Back units with casters



Ganging Bariatric units with link on Right side



Hip Height Chair with wedged cushion, 24" Seat Height



BENCHES & BRIDGES

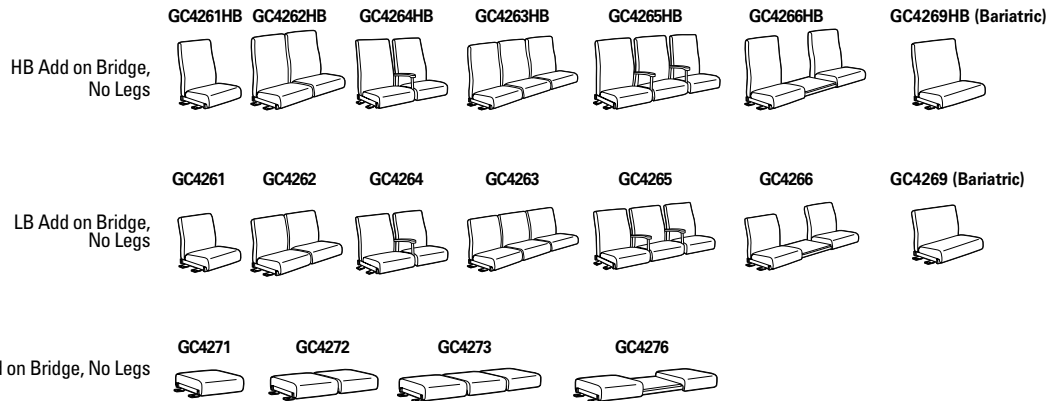
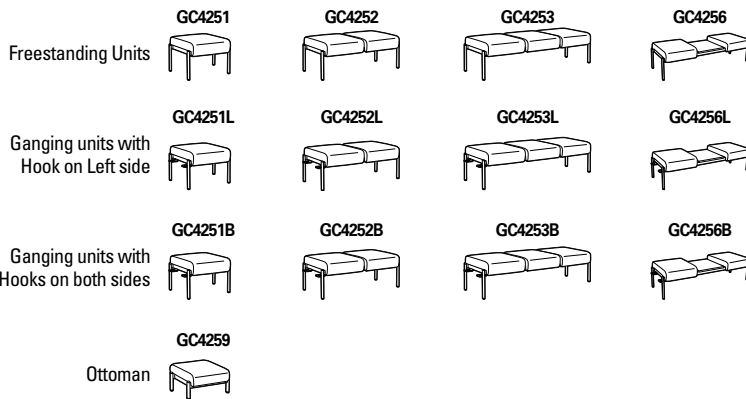

TABLES

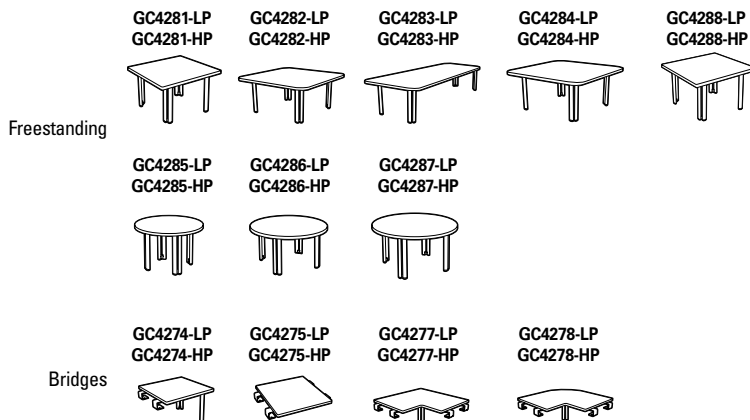

- A bridge unit suspends between 2 other units with legs and is supported by their linking brackets
- A bridge unit is **not** freestanding and cannot be made freestanding
- Units with legs and links can only gang with a bridge. They **cannot** gang directly with another link unit with legs
- Bridges **cannot** gang directly with another bridge

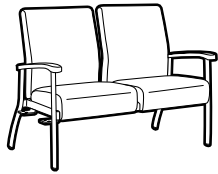

1, 2 or 3 seat chair with integrated ganging bracket

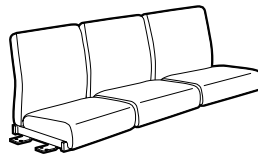

Any seating bridge unit connects to:

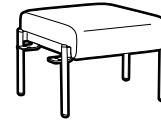

1, 2 or 3 seat bench with integrated ganging bracket



1, 2 or 3 seat chair with integrated ganging bracket

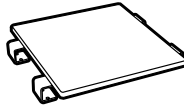

Any table bridge unit connects to:

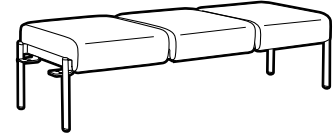

1, 2 or 3 seat bench with integrated ganging bracket

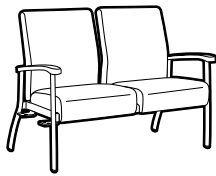

1, 2 or 3 seat chair with integrated ganging bracket



CANNOT connect to



1, 2 or 3 seat chair with integrated ganging bracket



Any table bridge unit



CANNOT connect to

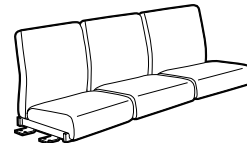

Any seating bridge unit



Any seating bridge unit



CANNOT connect to

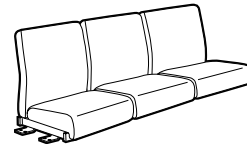

Any seating bridge unit



Any table bridge unit



CANNOT connect to



Any table bridge unit

PACKAGE 1



Description

Low Back Three Seat Chair

| Qty | Model Number | Dimensions | Ydg. | Freight Class | Wt./Lbs. | Cu. Ft. | List Price |
|-----|--------------|-------------------|------|---------------|----------|---------|------------|
| 4 | GC4235 | 72.75 x 26 x 37.5 | 5 | 250 | 142 | 65.25 | \$2926 |

PACKAGE TOTAL

(*Please Note: List Prices shown are for the standard Grade 2 vinyl/standard finishes.)

\$11,704

PACKAGE 2



Description

Low Back Three Seat Chair
 Low Back Armchair, Left
 Low Back Armchair, Right
 End Corner Table Bridge

| Qty | Model Number | Dimensions | Ydg. | Freight Class | Wt./Lbs. | Cu. Ft. | List Price |
|-----|--------------|-------------------|------|---------------|----------|---------|------------|
| 1 | GC4233B | 72.75 x 26 x 37.5 | 5 | 250 | 134 | 65.25 | \$2543 |
| 1 | GC4231L | 26.75 x 26 x 37.5 | 1.75 | 250 | 49 | 20.25 | \$1190 |
| 1 | GC4231R | 26.75 x 26 x 37.5 | 1.75 | 250 | 49 | 20.25 | \$1190 |
| 2 | GC4277-HP | 35 x 35 x 16 | -- | 125 | 45 | 6 | \$650 |

PACKAGE TOTAL

(* Please Note: List Prices shown are for the standard Grade 2 vinyl/standard laminate.)

\$6223

PACKAGE 3



Description

Low Back Armless Chair
 Low Back Armless Chair, Right
 Low Back Armless Chair, Left
 End Corner Table Bridge

| Qty | Model Number | Dimensions | Ydg. | Freight Class | Wt./Lbs. | Cu. Ft. | List Price |
|-----|--------------|-------------------|------|---------------|----------|---------|------------|
| 2 | GC4230B | 26.75 x 26 x 37.5 | 1.75 | 250 | 41 | 20.25 | \$986 |
| 1 | GC4230R | 24.75 x 26 x 37.5 | 1.75 | 250 | 41 | 20.25 | \$956 |
| 1 | GC4230L | 24.75 x 26 x 37.5 | 1.75 | 250 | 41 | 20.25 | \$956 |
| 3 | GC4277-HP | 35 x 35 x 16 | -- | 125 | 45 | 6 | \$650 |

PACKAGE TOTAL

(* Please Note: List Prices shown are for the standard Grade 2 vinyl/standard laminate.)

\$5834

PACKAGE 4



Description

Low Back Three Seat Chair
 Bariatric Low Back Armchair, Left
 Low Back Armchair, Left
 Low Back Armchair, Right
 End Corner Table Bridge
 Rectangular Coffee Table
 Square Table Top

| Qty | Model Number | Dimensions | Ydg. | Freight Class | Wt./Lbs. | Cu. Ft. | List Price |
|-----|--------------|-------------------|------|---------------|----------|---------|------------|
| 1 | GC4235R | 74.5 x 26 x 37.5 | 5 | 250 | 143 | 65.25 | \$2956 |
| 1 | GC4241L | 37.5 x 26 x 37.5 | 3 | 250 | 70 | 30.50 | \$1551 |
| 1 | GC4231L | 26.75 x 26 x 37.5 | 1.75 | 250 | 49 | 20.25 | \$1190 |
| 1 | GC4231R | 26.75 x 26 x 37.5 | 1.75 | 250 | 49 | 20.25 | \$1190 |
| 1 | GC4277-HP | 35 x 35 x 16 | -- | 125 | 45 | 6 | \$650 |
| 1 | GC4283-HP | 22 x 54 x 16 | -- | 125 | 37 | 6 | \$934 |
| 1 | GC4275-HP | 23 x 23 x 1 | -- | 150 | 18 | 3.40 | \$401 |



PACKAGE TOTAL

(* Please Note: List Prices shown are for the standard Grade 2 vinyl/standard laminate.)

\$8872

SEATING

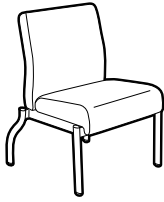
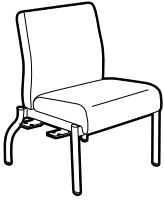
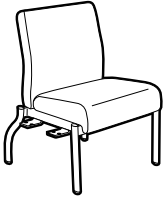
GC-BELONG G

| DESCRIPTION | MODEL# | STANDARD FABRIC GRADES | | | | | | | | | | | |
|--|----------|------------------------|-------|--------|-----------------|--------|--------|-----------------|--------|--------|--------|--------|--------|
| | | COM | 2 | 3 | 4 | 5 | 6 | 7 | 8 | 9 | 10 | 11 | 12 |
|  <p>Low Back Chair Armless COM Yardage: 1.75 Freight Class: 250 Product Weight (lbs.): 41 Cubic Feet Per Carton: 20.25</p> | GC4230 | \$885 | \$925 | \$959 | \$1008 | \$1077 | \$1104 | \$1165 | \$1280 | \$1336 | \$1443 | \$1591 | \$1774 |
| | | OVERALL DIMENSIONS | | | SEAT DIMENSIONS | | | BACK DIMENSIONS | | | | | |
| | | W | D | H | W | D | H | W | H | | | | |
| | | | | | | | | | | | | | |
|  <p>Low Back Chair Armless, Right COM Yardage: 1.75 Freight Class: 250 Product Weight (lbs.): 41 Cubic Feet Per Carton: 20.25</p> | GC4230R | \$915 | \$956 | \$989 | \$1038 | \$1107 | \$1134 | \$1195 | \$1310 | \$1367 | \$1473 | \$1621 | \$1804 |
| | | OVERALL DIMENSIONS | | | SEAT DIMENSIONS | | | BACK DIMENSIONS | | | | | |
| | | W | D | H | W | D | H | W | H | | | | |
| | | | | | | | | | | | | | |
|  <p>Low Back Chair Armless, Left COM Yardage: 1.75 Freight Class: 250 Product Weight (lbs.): 41 Cubic Feet Per Carton: 20.25</p> | GC4230L | \$915 | \$956 | \$989 | \$1038 | \$1107 | \$1134 | \$1195 | \$1310 | \$1367 | \$1473 | \$1621 | \$1804 |
| | | OVERALL DIMENSIONS | | | SEAT DIMENSIONS | | | BACK DIMENSIONS | | | | | |
| | | W | D | H | W | D | H | W | H | | | | |
| | | | | | | | | | | | | | |
|  <p>Low Back Chair Armless, Left & Right COM Yardage: 1.75 Freight Class: 250 Product Weight (lbs.): 41 Cubic Feet Per Carton: 20.25</p> | GC4230B | \$945 | \$986 | \$1019 | \$1068 | \$1137 | \$1165 | \$1225 | \$1340 | \$1397 | \$1503 | \$1652 | \$1834 |
| | | OVERALL DIMENSIONS | | | SEAT DIMENSIONS | | | BACK DIMENSIONS | | | | | |
| | | W | D | H | W | D | H | W | H | | | | |
| | | | | | | | | | | | | | |
|  <p>High Back Chair Armless COM Yardage: 2 Freight Class: 250 Product Weight (lbs.): 45 Cubic Feet Per Carton: 20.25</p> | GC4230HB | \$932 | \$978 | \$1015 | \$1072 | \$1151 | \$1181 | \$1251 | \$1382 | \$1448 | \$1569 | \$1738 | \$1947 |
| | | OVERALL DIMENSIONS | | | SEAT DIMENSIONS | | | BACK DIMENSIONS | | | | | |
| | | W | D | H | W | D | H | W | H | | | | |
| | | | | | | | | | | | | | |



| DESCRIPTION | MODEL# | STANDARD FABRIC GRADES | | | | | | | | | | | |
|---|-----------|------------------------|--------|--------|-----------------|--------|--------|-----------------|--------|--------|--------|--------|--------|
| | | COM | 2 | 3 | 4 | 5 | 6 | 7 | 8 | 9 | 10 | 11 | 12 |
|  <p>High Back Chair Armless, Right COM Yardage: 2 Freight Class: 250 Product Weight (lbs.): 45 Cubic Feet Per Carton: 20.25</p> | GC4230HBR | COM | 2 | 3 | 4 | 5 | 6 | 7 | 8 | 9 | 10 | 11 | 12 |
| | | \$962 | \$1008 | \$1045 | \$1102 | \$1181 | \$1212 | \$1282 | \$1412 | \$1478 | \$1599 | \$1769 | \$1978 |
| | | OVERALL DIMENSIONS | | | SEAT DIMENSIONS | | | BACK DIMENSIONS | | | | | |
| | | W | D | H | W | D | H | W | H | | | | |
| | | 25.75 | 26 | 42.5 | 22 | 18 | 18 | 21.5 | 24.5 | | | | |

| | | | | | | | | | | | | | |
|--|-----------|--------------------|--------|--------|-----------------|--------|--------|-----------------|--------|--------|--------|--------|--------|
|  <p>High Back Chair Armless, Left COM Yardage: 2 Freight Class: 250 Product Weight (lbs.): 45 Cubic Feet Per Carton: 20.25</p> | GC4230HBL | COM | 2 | 3 | 4 | 5 | 6 | 7 | 8 | 9 | 10 | 11 | 12 |
| | | \$962 | \$1008 | \$1045 | \$1102 | \$1181 | \$1212 | \$1282 | \$1412 | \$1478 | \$1599 | \$1769 | \$1978 |
| | | OVERALL DIMENSIONS | | | SEAT DIMENSIONS | | | BACK DIMENSIONS | | | | | |
| | | W | D | H | W | D | H | W | H | | | | |
| | | 25.75 | 26 | 42.5 | 22 | 18 | 18 | 21.5 | 24.5 | | | | |

| | | | | | | | | | | | | | |
|---|-----------|--------------------|--------|--------|-----------------|--------|--------|-----------------|--------|--------|--------|--------|--------|
|  <p>High Back Chair Armless, Left & Right COM Yardage: 2 Freight Class: 250 Product Weight (lbs.): 47 Cubic Feet Per Carton: 20.25</p> | GC4230HBB | COM | 2 | 3 | 4 | 5 | 6 | 7 | 8 | 9 | 10 | 11 | 12 |
| | | \$992 | \$1038 | \$1076 | \$1132 | \$1212 | \$1242 | \$1312 | \$1443 | \$1508 | \$1630 | \$1799 | \$2008 |
| | | OVERALL DIMENSIONS | | | SEAT DIMENSIONS | | | BACK DIMENSIONS | | | | | |
| | | W | D | H | W | D | H | W | H | | | | |
| | | 26.75 | 26 | 42.5 | 22 | 18 | 18 | 21.5 | 24.5 | | | | |

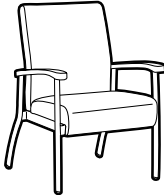
| | | | | | | | | | | | | | |
|---|--------|--------------------------------|--------|--------|-----------------|--------|--------|-----------------|--------|--------|--------|--------|--------|
|  <p>Low Back Armchair COM Yardage: 1.75 Freight Class: 250 Product Weight (lbs.): 52 Cubic Feet Per Carton: 20.25</p> | GC4231 | COM | 2 | 3 | 4 | 5 | 6 | 7 | 8 | 9 | 10 | 11 | 12 |
| | | \$1080 | \$1120 | \$1153 | \$1202 | \$1272 | \$1298 | \$1359 | \$1474 | \$1531 | \$1638 | \$1786 | \$1968 |
| | | OVERALL DIMENSIONS | | | SEAT DIMENSIONS | | | BACK DIMENSIONS | | | | | |
| | | W | D | H | W | D | H | W | H | | | | |
| | | 26.75 | 26 | 37.5 | 22 | 18 | 18 | 21.5 | 19.5 | | | | |
| | | Wood armcap option - Add \$118 | | | | | | | | | | | |

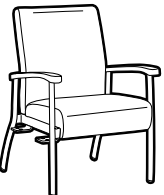
| | | | | | | | | | | | | | |
|---|---------|--------------------------------|--------|--------|-----------------|--------|--------|-----------------|--------|--------|--------|--------|--------|
|  <p>Low Back Armchair Right COM Yardage: 1.75 Freight Class: 250 Product Weight (lbs.): 49 Cubic Feet Per Carton: 20.25</p> | GC4231R | COM | 2 | 3 | 4 | 5 | 6 | 7 | 8 | 9 | 10 | 11 | 12 |
| | | \$1149 | \$1190 | \$1223 | \$1272 | \$1341 | \$1368 | \$1429 | \$1544 | \$1601 | \$1707 | \$1855 | \$2038 |
| | | OVERALL DIMENSIONS | | | SEAT DIMENSIONS | | | BACK DIMENSIONS | | | | | |
| | | W | D | H | W | D | H | W | H | | | | |
| | | 26.75 | 26 | 37.5 | 22 | 18 | 18 | 21.5 | 19.5 | | | | |
| | | Wood armcap option - Add \$118 | | | | | | | | | | | |

SEATING

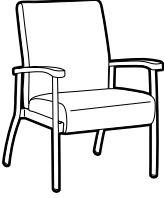
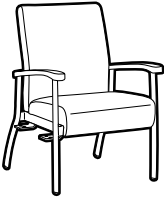
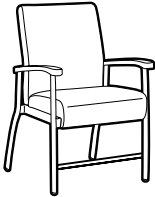
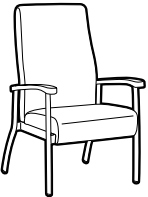
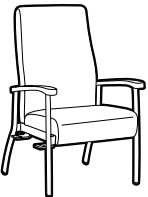
| DESCRIPTION | MODEL# | STANDARD FABRIC GRADES | | | | | | | | | | | |
|--|------------------------------|---------------------------|--------|--------|------------------------|--------|--------|------------------------|--------|--------|--------|--------|--------|
| | | COM | 2 | 3 | 4 | 5 | 6 | 7 | 8 | 9 | 10 | 11 | 12 |
|  <p>Low Back Armchair Left COM Yardage: 1.75 Freight Class: 250 Product Weight (lbs.): 49 Cubic Feet Per Carton: 20.25</p> | GC4231L | \$1149 | \$1190 | \$1223 | \$1272 | \$1341 | \$1368 | \$1429 | \$1544 | \$1601 | \$1707 | \$1855 | \$2038 |
| | | OVERALL DIMENSIONS | | | SEAT DIMENSIONS | | | BACK DIMENSIONS | | | | | |
| | | W | D | H | W | D | H | W | H | | | | |
| | | | 26.75 | 26 | 37.5 | 22 | 18 | 18 | 21.5 | 19.5 | | | |
| <p>Wood armcap option - Add \$118</p> | | | | | | | | | | | | | |
|  <p>Low Back Armchair Left & Right COM Yardage: 1.75 Freight Class: 250 Product Weight (lbs.): 49 Cubic Feet Per Carton: 20.25</p> | GC4231B | \$1178 | \$1219 | \$1252 | \$1302 | \$1370 | \$1398 | \$1458 | \$1573 | \$1630 | \$1736 | \$1885 | \$2068 |
| | | OVERALL DIMENSIONS | | | SEAT DIMENSIONS | | | BACK DIMENSIONS | | | | | |
| | | W | D | H | W | D | H | W | H | | | | |
| | | | 26.75 | 26 | 37.5 | 22 | 18 | 18 | 21.5 | 19.5 | | | |
| <p>Wood armcap option - Add \$118</p> | | | | | | | | | | | | | |
|  <p>Low Back Armchair Post Surgery. Designed to immobilize the pelvis and hip joints after surgery. COM Yardage: 1.75 Freight Class: 250 Product Weight (lbs.): 53 Cubic Feet Per Carton: 22.25</p> | GC4231-24 24" Seat Height | \$1289 | \$1330 | \$1363 | \$1412 | \$1482 | \$1508 | \$1569 | \$1684 | \$1741 | \$1848 | \$1995 | \$2178 |
| | | OVERALL DIMENSIONS | | | SEAT DIMENSIONS | | | BACK DIMENSIONS | | | | | |
| | | W | D | H | W | D | H | W | H | | | | |
| | | | 26.75 | 26 | 43.5 | 22 | 18 | 24 | 21.5 | 19.5 | | | |
| <p>Wood armcap option - Add \$118</p> | | | | | | | | | | | | | |
|  <p>High Back Armchair COM Yardage: 2 Freight Class: 250 Product Weight (lbs.): 54 Cubic Feet Per Carton: 20.25</p> | GC4231HB | \$1153 | \$1198 | \$1237 | \$1293 | \$1373 | \$1403 | \$1472 | \$1604 | \$1669 | \$1791 | \$1960 | \$2169 |
| | | OVERALL DIMENSIONS | | | SEAT DIMENSIONS | | | BACK DIMENSIONS | | | | | |
| | | W | D | H | W | D | H | W | H | | | | |
| | | | 26.75 | 26 | 42.5 | 22 | 18 | 18 | 21.5 | 24.5 | | | |
| <p>Wood armcap option - Add \$118</p> | | | | | | | | | | | | | |
|  <p>High Back Armchair Right COM Yardage: 2 Freight Class: 250 Product Weight (lbs.): 54 Cubic Feet Per Carton: 20.25</p> | GC4231HBR | \$1181 | \$1227 | \$1265 | \$1321 | \$1401 | \$1431 | \$1501 | \$1632 | \$1698 | \$1819 | \$1988 | \$2197 |
| | | OVERALL DIMENSIONS | | | SEAT DIMENSIONS | | | BACK DIMENSIONS | | | | | |
| | | W | D | H | W | D | H | W | H | | | | |
| | | | 26.75 | 26 | 42.5 | 22 | 18 | 18 | 21.5 | 24.5 | | | |
| <p>Wood armcap option - Add \$118</p> | | | | | | | | | | | | | |

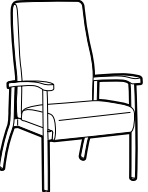
| DESCRIPTION | MODEL# | STANDARD FABRIC GRADES | | | | | | | | | | | |
|--|-----------|------------------------|--------|--------|-----------------|--------|--------|-----------------|--------|--------|--------|--------|--------|
| | | COM | 2 | 3 | 4 | 5 | 6 | 7 | 8 | 9 | 10 | 11 | 12 |
|  <p>High Back Armchair Left COM Yardage: 2 Freight Class: 250 Product Weight (lbs.): 54 Cubic Feet Per Carton: 20.25</p> | GC4231HBL | \$1181 | \$1227 | \$1265 | \$1321 | \$1401 | \$1431 | \$1501 | \$1632 | \$1698 | \$1819 | \$1988 | \$2197 |
| | | OVERALL DIMENSIONS | | | SEAT DIMENSIONS | | | BACK DIMENSIONS | | | | | |
| | | W | D | H | W | D | H | W | H | | | | |
| | | | 26.75 | 26 | 42.5 | 22 | 18 | 18 | 21.5 | 24.5 | | | |

Wood armcap option - Add \$118

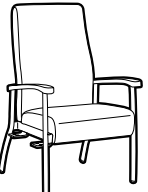
| | | | | | | | | | | | | | |
|--|-----------|--------------------|--------|--------|-----------------|--------|--------|-----------------|--------|--------|--------|--------|--------|
|  <p>High Back Armchair Left & Right COM Yardage: 2 Freight Class: 250 Product Weight (lbs.): 56 Cubic Feet Per Carton: 20.25</p> | GC4231HBB | \$1211 | \$1257 | \$1294 | \$1351 | \$1430 | \$1460 | \$1530 | \$1661 | \$1727 | \$1848 | \$2017 | \$2226 |
| | | OVERALL DIMENSIONS | | | SEAT DIMENSIONS | | | BACK DIMENSIONS | | | | | |
| | | W | D | H | W | D | H | W | H | | | | |
| | | | 26.75 | 26 | 42.5 | 22 | 18 | 18 | 21.5 | 24.5 | | | |

Wood armcap option - Add \$118

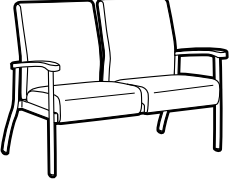
| | | | | | | | | | | | | | |
|--|--------|--------------------|--------|--------|-----------------|--------|--------|-----------------|--------|--------|--------|--------|--------|
|  <p>Low Back Two Seat Chair No Center Arm COM Yardage: 3.50 Freight Class: 250 Product Weight (lbs.): 94 Cubic Feet Per Carton: 45.75</p> | GC4232 | \$1747 | \$1827 | \$1894 | \$1992 | \$2131 | \$2185 | \$2307 | \$2536 | \$2651 | \$2863 | \$3160 | \$3524 |
| | | OVERALL DIMENSIONS | | | SEAT DIMENSIONS | | | BACK DIMENSIONS | | | | | |
| | | W | D | H | W | D | H | W | H | | | | |
| | | | 49.75 | 26 | 37.5 | 44 | 18 | 18 | 44 | 19.5 | | | |

Wood armcap option - Add \$118

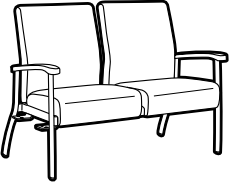
| | | | | | | | | | | | | | |
|--|---------|--------------------|--------|--------|-----------------|--------|--------|-----------------|--------|--------|--------|--------|--------|
|  <p>Low Back Two Seat Chair No Center Arm, Right COM Yardage: 3.50 Freight Class: 250 Product Weight (lbs.): 95 Cubic Feet Per Carton: 45.75</p> | GC4232R | \$1775 | \$1856 | \$1922 | \$2020 | \$2159 | \$2213 | \$2335 | \$2564 | \$2679 | \$2891 | \$3188 | \$3552 |
| | | OVERALL DIMENSIONS | | | SEAT DIMENSIONS | | | BACK DIMENSIONS | | | | | |
| | | W | D | H | W | D | H | W | H | | | | |
| | | | 49.75 | 26 | 37.5 | 44 | 18 | 18 | 44 | 19.5 | | | |

Wood armcap option - Add \$118

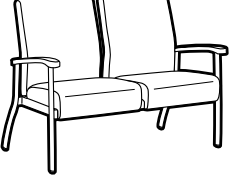
| | | | | | | | | | | | | | |
|---|---------|--------------------|--------|--------|-----------------|--------|--------|-----------------|--------|--------|--------|--------|--------|
|  <p>Low Back Two Seat Chair No Center Arm, Left COM Yardage: 3.50 Freight Class: 250 Product Weight (lbs.): 95 Cubic Feet Per Carton: 45.75</p> | GC4232L | \$1775 | \$1856 | \$1922 | \$2020 | \$2159 | \$2213 | \$2335 | \$2564 | \$2679 | \$2891 | \$3188 | \$3552 |
| | | OVERALL DIMENSIONS | | | SEAT DIMENSIONS | | | BACK DIMENSIONS | | | | | |
| | | W | D | H | W | D | H | W | H | | | | |
| | | | 49.75 | 26 | 37.5 | 44 | 18 | 18 | 44 | 19.5 | | | |

Wood armcap option - Add \$118

SEATING

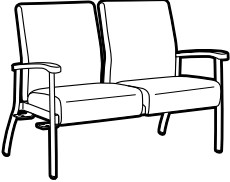
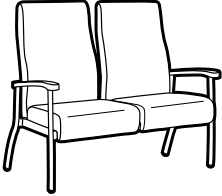
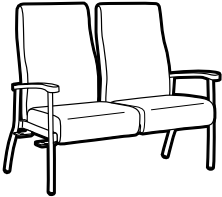
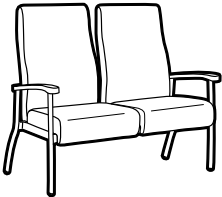
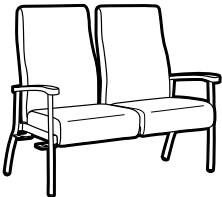
| DESCRIPTION | MODEL# | STANDARD FABRIC GRADES | | | | | | | | | | | |
|---|-----------|------------------------|--------|--------|-----------------|--------|--------|-----------------|--------|--------|--------|--------|--------|
| | | COM | 2 | 3 | 4 | 5 | 6 | 7 | 8 | 9 | 10 | 11 | 12 |
|  <p>Low Back Two Seat Chair No Center Arm, Left & Right COM Yardage: 3.50 Freight Class: 250 Product Weight (lbs.): 96 Cubic Feet Per Carton: 45.75</p> | GC4232B | \$1803 | \$1885 | \$1950 | \$2049 | \$2188 | \$2241 | \$2362 | \$2592 | \$2706 | \$2919 | \$3215 | \$3581 |
| | | OVERALL DIMENSIONS | | | SEAT DIMENSIONS | | | BACK DIMENSIONS | | | | | |
| | | W | D | H | W | D | H | W | H | | | | |
| | | | | | | | | | | | | | |
| | | | | | | | | | | | | | |
|  <p>High Back Two Seat Chair No Center Arm COM Yardage: 4 Freight Class: 300 Product Weight (lbs.): 97 Cubic Feet Per Carton: 56.50</p> | GC4232HB | \$1872 | \$1965 | \$2040 | \$2153 | \$2312 | \$2372 | \$2512 | \$2773 | \$2905 | \$3148 | \$3486 | \$3904 |
| | | OVERALL DIMENSIONS | | | SEAT DIMENSIONS | | | BACK DIMENSIONS | | | | | |
| | | W | D | H | W | D | H | W | H | | | | |
| | | | | | | | | | | | | | |
| | | | | | | | | | | | | | |
|  <p>High Back Two Seat Chair No Center Arm, Right COM Yardage: 4 Freight Class: 300 Product Weight (lbs.): 96 Cubic Feet Per Carton: 56.50</p> | GC4232HBR | \$1900 | \$1993 | \$2069 | \$2181 | \$2340 | \$2400 | \$2540 | \$2801 | \$2933 | \$3176 | \$3514 | \$3932 |
| | | OVERALL DIMENSIONS | | | SEAT DIMENSIONS | | | BACK DIMENSIONS | | | | | |
| | | W | D | H | W | D | H | W | H | | | | |
| | | | | | | | | | | | | | |
| | | | | | | | | | | | | | |
|  <p>High Back Two Seat Chair No Center Arm, Left COM Yardage: 4 Freight Class: 300 Product Weight (lbs.): 96 Cubic Feet Per Carton: 56.50</p> | GC4232HBL | \$1900 | \$1993 | \$2069 | \$2181 | \$2340 | \$2400 | \$2540 | \$2801 | \$2933 | \$3176 | \$3514 | \$3932 |
| | | OVERALL DIMENSIONS | | | SEAT DIMENSIONS | | | BACK DIMENSIONS | | | | | |
| | | W | D | H | W | D | H | W | H | | | | |
| | | | | | | | | | | | | | |
| | | | | | | | | | | | | | |
|  <p>High Back Two Seat Chair No Center Arm, Left & Right COM Yardage: 4 Freight Class: 300 Product Weight (lbs.): 98 Cubic Feet Per Carton: 56.50</p> | GC4232HBB | \$1929 | \$2022 | \$2097 | \$2210 | \$2368 | \$2428 | \$2568 | \$2829 | \$2961 | \$3204 | \$3542 | \$3960 |
| | | OVERALL DIMENSIONS | | | SEAT DIMENSIONS | | | BACK DIMENSIONS | | | | | |
| | | W | D | H | W | D | H | W | H | | | | |
| | | | | | | | | | | | | | |
| | | | | | | | | | | | | | |

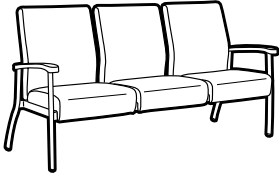
| DESCRIPTION | MODEL# | STANDARD FABRIC GRADES | | | | | | | | | | | |
|---|--------|------------------------------------|--------|--------|---------------------------------|--------|--------|-------------------------------|--------|--------|--------|--------|--------|
| | | COM | 2 | 3 | 4 | 5 | 6 | 7 | 8 | 9 | 10 | 11 | 12 |
|  <p>Low Back Three Seat Chair No Center Arm COM Yardage: 5 Freight Class: 250 Product Weight (lbs.): 132 Cubic Feet Per Carton: 65.25</p> | GC4233 | \$2372 | \$2488 | \$2582 | \$2722 | \$2920 | \$2997 | \$3170 | \$3497 | \$3661 | \$3965 | \$4388 | \$4911 |
| | | OVERALL DIMENSIONS W D H | | | SEAT DIMENSIONS W D H | | | BACK DIMENSIONS W H | | | | | |
| | | 72.75 | 26 | 37.5 | | 70 | 18 | 18 | | 70 | | 19.5 | |

Wood armcap option - Add \$118

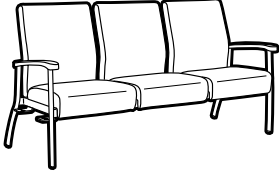
| | | | | | | | | | | | | | |
|--|---------|------------------------------------|--------|--------|---------------------------------|--------|--------|-------------------------------|--------|--------|--------|--------|--------|
|  <p>Low Back Three Seat Chair No Center Arm, Right COM Yardage: 5 Freight Class: 250 Product Weight (lbs.): 134 Cubic Feet Per Carton: 65.25</p> | GC4233R | \$2400 | \$2516 | \$2610 | \$2751 | \$2949 | \$3025 | \$3198 | \$3526 | \$3689 | \$3994 | \$4417 | \$4939 |
| | | OVERALL DIMENSIONS W D H | | | SEAT DIMENSIONS W D H | | | BACK DIMENSIONS W H | | | | | |
| | | 72.75 | 26 | 37.5 | | 70 | 18 | 18 | | 70 | | 19.5 | |

Wood armcap option - Add \$118

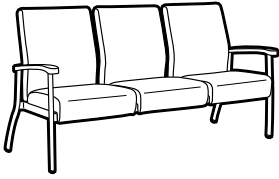
| | | | | | | | | | | | | | |
|--|---------|------------------------------------|--------|--------|---------------------------------|--------|--------|-------------------------------|--------|--------|--------|--------|--------|
|  <p>Low Back Three Seat Chair No Center Arm, Left COM Yardage: 5 Freight Class: 250 Product Weight (lbs.): 134 Cubic Feet Per Carton: 65.25</p> | GC4233L | \$2400 | \$2516 | \$2610 | \$2751 | \$2949 | \$3025 | \$3198 | \$3526 | \$3689 | \$3994 | \$4417 | \$4939 |
| | | OVERALL DIMENSIONS W D H | | | SEAT DIMENSIONS W D H | | | BACK DIMENSIONS W H | | | | | |
| | | 72.75 | 26 | 37.5 | | 70 | 18 | 18 | | 70 | | 19.5 | |

Wood armcap option - Add \$118

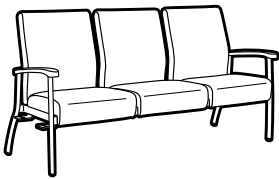
| | | | | | | | | | | | | | |
|---|---------|------------------------------------|--------|--------|---------------------------------|--------|--------|-------------------------------|--------|--------|--------|--------|--------|
|  <p>Low Back Three Seat Chair No Center Arm, Left & Right COM Yardage: 5 Freight Class: 250 Product Weight (lbs.): 134 Cubic Feet Per Carton: 65.25</p> | GC4233B | \$2427 | \$2543 | \$2637 | \$2777 | \$2976 | \$3052 | \$3225 | \$3552 | \$3717 | \$4021 | \$4444 | \$4966 |
| | | OVERALL DIMENSIONS W D H | | | SEAT DIMENSIONS W D H | | | BACK DIMENSIONS W H | | | | | |
| | | 72.75 | 26 | 37.5 | | 70 | 18 | 18 | | 70 | | 19.5 | |

Wood armcap option - Add \$118

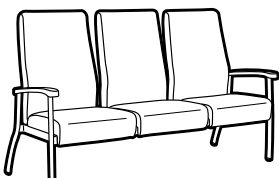
| | | | | | | | | | | | | | |
|---|----------|------------------------------------|--------|--------|---------------------------------|--------|--------|-------------------------------|--------|--------|--------|--------|--------|
|  <p>High Back Three Seat Chair No Center Arm COM Yardage: 5.75 Freight Class: 300 Product Weight (lbs.): 138 Cubic Feet Per Carton: 80.75</p> | GC4233HB | \$2558 | \$2691 | \$2800 | \$2961 | \$3190 | \$3277 | \$3476 | \$3852 | \$4042 | \$4392 | \$4878 | \$5477 |
| | | OVERALL DIMENSIONS W D H | | | SEAT DIMENSIONS W D H | | | BACK DIMENSIONS W H | | | | | |
| | | 72.75 | 26 | 42.5 | | 70 | 18 | 18 | | 70 | | 24.5 | |

Wood armcap option - Add \$118

SEATING

GC-BELONG G

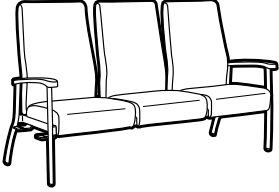
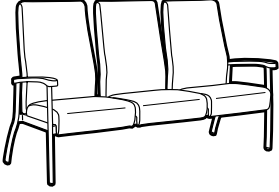
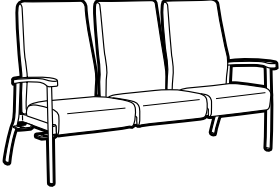
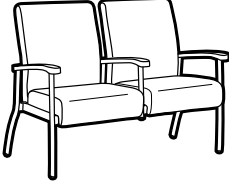
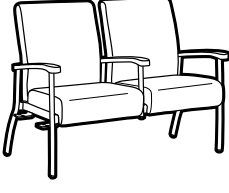
| DESCRIPTION | MODEL# | STANDARD FABRIC GRADES | | | | | | | | | | | |
|--|-----------|---------------------------------------|--------|--------|------------------------|--------|--------|------------------------|--------|--------|--------|--------|--------|
| | | COM | 2 | 3 | 4 | 5 | 6 | 7 | 8 | 9 | 10 | 11 | 12 |
|  <p>High Back Three Seat Chair No Center Arm, Right COM Yardage: 5.75 Freight Class: 300 Product Weight (lbs.): 152 Cubic Feet Per Carton: 80.75</p> | GC4233HBR | COM | 2 | 3 | 4 | 5 | 6 | 7 | 8 | 9 | 10 | 11 | 12 |
| | | \$2586 | \$2720 | \$2828 | \$2989 | \$3218 | \$3305 | \$3504 | \$3882 | \$4070 | \$4420 | \$4906 | \$5506 |
| | | OVERALL DIMENSIONS | | | SEAT DIMENSIONS | | | BACK DIMENSIONS | | | | | |
| | | W | D | H | W | D | H | W | H | | | | |
| | | 72.75 | 26 | 42.5 | 70 | 18 | 18 | 70 | 24.5 | | | | |
| | | Wood armcap option - Add \$118 | | | | | | | | | | | |
|  <p>High Back Three Seat Chair No Center Arm, Left COM Yardage: 5.75 Freight Class: 300 Product Weight (lbs.): 140 Cubic Feet Per Carton: 80.75</p> | GC4233HBL | COM | 2 | 3 | 4 | 5 | 6 | 7 | 8 | 9 | 10 | 11 | 12 |
| | | \$2586 | \$2720 | \$2828 | \$2989 | \$3218 | \$3305 | \$3504 | \$3882 | \$4070 | \$4420 | \$4906 | \$5506 |
| | | OVERALL DIMENSIONS | | | SEAT DIMENSIONS | | | BACK DIMENSIONS | | | | | |
| | | W | D | H | W | D | H | W | H | | | | |
| | | 72.75 | 26 | 42.5 | 70 | 18 | 18 | 70 | 24.5 | | | | |
| | | Wood armcap option - Add \$118 | | | | | | | | | | | |
|  <p>High Back Three Seat Chair No Center Arm, Left & Right COM Yardage: 5.75 Freight Class: 300 Product Weight (lbs.): 140 Cubic Feet Per Carton: 80.75</p> | GC4233HBB | COM | 2 | 3 | 4 | 5 | 6 | 7 | 8 | 9 | 10 | 11 | 12 |
| | | \$2614 | \$2748 | \$2856 | \$3017 | \$3246 | \$3333 | \$3533 | \$3909 | \$4098 | \$4448 | \$4934 | \$5534 |
| | | OVERALL DIMENSIONS | | | SEAT DIMENSIONS | | | BACK DIMENSIONS | | | | | |
| | | W | D | H | W | D | H | W | H | | | | |
| | | 72.75 | 26 | 42.5 | 70 | 18 | 18 | 70 | 24.5 | | | | |
| | | Wood armcap option - Add \$118 | | | | | | | | | | | |
|  <p>Low Back Two Seat Chair Half Center Arm COM Yardage: 3.5 Freight Class: 250 Product Weight (lbs.): 100 Cubic Feet Per Carton: 45.75</p> | GC4234 | COM | 2 | 3 | 4 | 5 | 6 | 7 | 8 | 9 | 10 | 11 | 12 |
| | | \$1972 | \$2054 | \$2120 | \$2218 | \$2357 | \$2410 | \$2531 | \$2761 | \$2875 | \$3088 | \$3384 | \$3750 |
| | | OVERALL DIMENSIONS | | | SEAT DIMENSIONS | | | BACK DIMENSIONS | | | | | |
| | | W | D | H | W | D | H | W | H | | | | |
| | | 50.75 | 26 | 37.5 | 22 | 18 | 18 | 21.5 | 19.5 | | | | |
| | | Wood armcap option - Add \$176 | | | | | | | | | | | |
|  <p>Low Back Two Seat Chair Half Center Arm, Right COM Yardage: 3.5 Freight Class: 250 Product Weight (lbs.): 101 Cubic Feet Per Carton: 45.75</p> | GC4234R | COM | 2 | 3 | 4 | 5 | 6 | 7 | 8 | 9 | 10 | 11 | 12 |
| | | \$2002 | \$2083 | \$2149 | \$2247 | \$2386 | \$2440 | \$2561 | \$2791 | \$2906 | \$3118 | \$3415 | \$3779 |
| | | OVERALL DIMENSIONS | | | SEAT DIMENSIONS | | | BACK DIMENSIONS | | | | | |
| | | W | D | H | W | D | H | W | H | | | | |
| | | 50.75 | 26 | 37.5 | 22 | 18 | 18 | 21.5 | 19.5 | | | | |
| | | Wood armcap option - Add \$176 | | | | | | | | | | | |

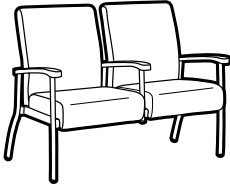
| DESCRIPTION | MODEL# | STANDARD FABRIC GRADES | | | | | | | | | | | |
|---|---------|------------------------|--------|--------|-----------------|--------|--------|-----------------|--------|--------|--------|--------|--------|
| | | COM | 2 | 3 | 4 | 5 | 6 | 7 | 8 | 9 | 10 | 11 | 12 |
|  <p>Low Back Two Seat Chair Half Center Arm, Left COM Yardage: 3.5 Freight Class: 250 Product Weight (lbs.): 101 Cubic Feet Per Carton: 45.75</p> | GC4234L | COM | 2 | 3 | 4 | 5 | 6 | 7 | 8 | 9 | 10 | 11 | 12 |
| | | \$2002 | \$2083 | \$2149 | \$2247 | \$2386 | \$2440 | \$2561 | \$2791 | \$2906 | \$3118 | \$3415 | \$3779 |
| | | OVERALL DIMENSIONS | | | SEAT DIMENSIONS | | | BACK DIMENSIONS | | | | | |
| | | W | D | H | W | D | H | W | H | | | | |
| | | 50.75 | 26 | 37.5 | 22 | 18 | 18 | 21.5 | 19.5 | | | | |

Wood armcap option - Add \$176

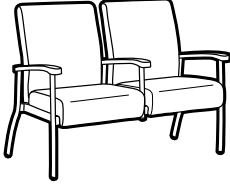
| | | | | | | | | | | | | | |
|---|---------|--------------------|--------|--------|-----------------|--------|--------|-----------------|--------|--------|--------|--------|--------|
|  <p>Low Back Two Seat Chair Half Center Arm, Left & Right COM Yardage: 3.5 Freight Class: 250 Product Weight (lbs.): 102 Cubic Feet Per Carton: 45.75</p> | GC4234B | COM | 2 | 3 | 4 | 5 | 6 | 7 | 8 | 9 | 10 | 11 | 12 |
| | | \$2031 | \$2112 | \$2178 | \$2277 | \$2415 | \$2469 | \$2590 | \$2820 | \$2934 | \$3147 | \$3443 | \$3808 |
| | | OVERALL DIMENSIONS | | | SEAT DIMENSIONS | | | BACK DIMENSIONS | | | | | |
| | | W | D | H | W | D | H | W | H | | | | |
| | | 50.75 | 26 | 37.5 | 22 | 18 | 18 | 21.5 | 19.5 | | | | |

Wood armcap option - Add \$176

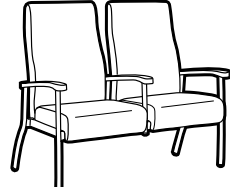
| | | | | | | | | | | | | | |
|---|----------|--------------------|--------|--------|-----------------|--------|--------|-----------------|--------|--------|--------|--------|--------|
|  <p>High Back Two Seat Chair Half Center Arm COM Yardage: 4 Freight Class: 300 Product Weight (lbs.): 104 Cubic Feet Per Carton: 56.50</p> | GC4234HB | COM | 2 | 3 | 4 | 5 | 6 | 7 | 8 | 9 | 10 | 11 | 12 |
| | | \$2149 | \$2242 | \$2317 | \$2429 | \$2589 | \$2649 | \$2789 | \$3050 | \$3181 | \$3425 | \$3762 | \$4180 |
| | | OVERALL DIMENSIONS | | | SEAT DIMENSIONS | | | BACK DIMENSIONS | | | | | |
| | | W | D | H | W | D | H | W | H | | | | |
| | | 50.75 | 26 | 42.5 | 22 | 18 | 18 | 21.5 | 24.5 | | | | |

Wood armcap option - Add \$176

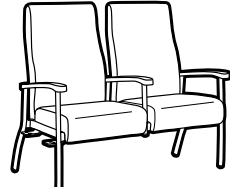
| | | | | | | | | | | | | | |
|---|-----------|--------------------|--------|--------|-----------------|--------|--------|-----------------|--------|--------|--------|--------|--------|
|  <p>High Back Two Seat Chair Half Center Arm, Right COM Yardage: 4 Freight Class: 300 Product Weight (lbs.): 104 Cubic Feet Per Carton: 56.50</p> | GC4234HBR | COM | 2 | 3 | 4 | 5 | 6 | 7 | 8 | 9 | 10 | 11 | 12 |
| | | \$2179 | \$2272 | \$2348 | \$2460 | \$2619 | \$2680 | \$2819 | \$3080 | \$3212 | \$3455 | \$3793 | \$4211 |
| | | OVERALL DIMENSIONS | | | SEAT DIMENSIONS | | | BACK DIMENSIONS | | | | | |
| | | W | D | H | W | D | H | W | H | | | | |
| | | 50.75 | 26 | 42.5 | 22 | 18 | 18 | 21.5 | 24.5 | | | | |

Wood armcap option - Add \$176

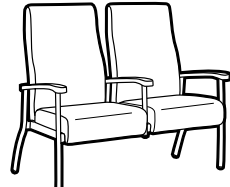
| | | | | | | | | | | | | | |
|--|-----------|--------------------|--------|--------|-----------------|--------|--------|-----------------|--------|--------|--------|--------|--------|
|  <p>High Back Two Seat Chair Half Center Arm, Left COM Yardage: 4 Freight Class: 300 Product Weight (lbs.): 104 Cubic Feet Per Carton: 56.50</p> | GC4234HBL | COM | 2 | 3 | 4 | 5 | 6 | 7 | 8 | 9 | 10 | 11 | 12 |
| | | \$2179 | \$2272 | \$2348 | \$2460 | \$2619 | \$2680 | \$2819 | \$3080 | \$3212 | \$3455 | \$3793 | \$4211 |
| | | OVERALL DIMENSIONS | | | SEAT DIMENSIONS | | | BACK DIMENSIONS | | | | | |
| | | W | D | H | W | D | H | W | H | | | | |
| | | 50.75 | 26 | 42.5 | 22 | 18 | 18 | 21.5 | 24.5 | | | | |

Wood armcap option - Add \$176

SEATING

GC-BELONG G

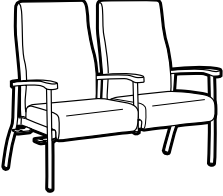
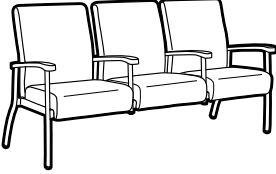
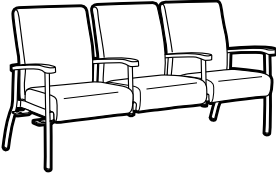
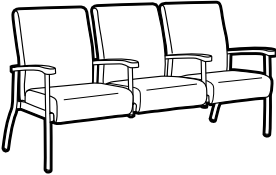
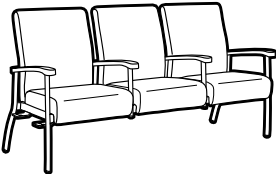
| DESCRIPTION | MODEL# | STANDARD FABRIC GRADES | | | | | | | | | | | |
|--|-----------|---------------------------|--------|--------|------------------------|--------|--------|------------------------|--------|--------|--------|--------|--------|
| | | COM | 2 | 3 | 4 | 5 | 6 | 7 | 8 | 9 | 10 | 11 | 12 |
|  <p>High Back Two Seat Chair Half Center Arm, Left & Right COM Yardage: 4 Freight Class: 300 Product Weight (lbs.): 108 Cubic Feet Per Carton: 56.50</p> | GC4234HBB | \$2209 | \$2302 | \$2377 | \$2490 | \$2649 | \$2709 | \$2848 | \$3109 | \$3241 | \$3485 | \$3822 | \$4240 |
| | | OVERALL DIMENSIONS | | | SEAT DIMENSIONS | | | BACK DIMENSIONS | | | | | |
| | | W | D | H | W | D | H | W | H | | | | |
| | | | 50.75 | 26 | 42.5 | 22 | 18 | 18 | 21.5 | 24.5 | | | |
| Wood armcap option - Add \$176 | | | | | | | | | | | | | |
|  <p>Low Back Three Seat Chair Half Center Arms COM Yardage: 5 Freight Class: 250 Product Weight (lbs.): 142 Cubic Feet Per Carton: 65.25</p> | GC4235 | \$2811 | \$2926 | \$3021 | \$3161 | \$3359 | \$3435 | \$3609 | \$3936 | \$4100 | \$4404 | \$4827 | \$5350 |
| | | OVERALL DIMENSIONS | | | SEAT DIMENSIONS | | | BACK DIMENSIONS | | | | | |
| | | W | D | H | W | D | H | W | H | | | | |
| | | | 74.5 | 26 | 37.5 | 22 | 18 | 18 | 21.5 | 19.5 | | | |
| Wood armcap option - Add \$235 | | | | | | | | | | | | | |
|  <p>Low Back Three Seat Chair Half Center Arms, Right COM Yardage: 5 Freight Class: 250 Product Weight (lbs.): 143 Cubic Feet Per Carton: 65.25</p> | GC4235R | \$2840 | \$2956 | \$3050 | \$3190 | \$3389 | \$3465 | \$3638 | \$3966 | \$4129 | \$4434 | \$4857 | \$5379 |
| | | OVERALL DIMENSIONS | | | SEAT DIMENSIONS | | | BACK DIMENSIONS | | | | | |
| | | W | D | H | W | D | H | W | H | | | | |
| | | | 74.5 | 26 | 37.5 | 22 | 18 | 18 | 21.5 | 19.5 | | | |
| Wood armcap option - Add \$235 | | | | | | | | | | | | | |
|  <p>Low Back Three Seat Chair Half Center Arms, Left COM Yardage: 5 Freight Class: 250 Product Weight (lbs.): 143 Cubic Feet Per Carton: 65.25</p> | GC4235L | \$2840 | \$2956 | \$3050 | \$3190 | \$3389 | \$3465 | \$3638 | \$3966 | \$4129 | \$4434 | \$4857 | \$5379 |
| | | OVERALL DIMENSIONS | | | SEAT DIMENSIONS | | | BACK DIMENSIONS | | | | | |
| | | W | D | H | W | D | H | W | H | | | | |
| | | | 74.5 | 26 | 37.5 | 22 | 18 | 18 | 21.5 | 19.5 | | | |
| Wood armcap option - Add \$235 | | | | | | | | | | | | | |
|  <p>Low Back Three Seat Chair Half Center Arms, Left & Right COM Yardage: 5 Freight Class: 250 Product Weight (lbs.): 145 Cubic Feet Per Carton: 65.25</p> | GC4235B | \$2868 | \$2984 | \$3078 | \$3218 | \$3417 | \$3493 | \$3666 | \$3993 | \$4158 | \$4462 | \$4885 | \$5407 |
| | | OVERALL DIMENSIONS | | | SEAT DIMENSIONS | | | BACK DIMENSIONS | | | | | |
| | | W | D | H | W | D | H | W | H | | | | |
| | | | 74.5 | 26 | 37.5 | 22 | 18 | 18 | 21.5 | 19.5 | | | |
| Wood armcap option - Add \$235 | | | | | | | | | | | | | |

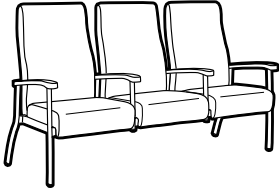
| DESCRIPTION | MODEL# | STANDARD FABRIC GRADES | | | | | | | | | | | |
|--|----------|------------------------------------|--------|--------|---------------------------------|--------|--------|-------------------------------|--------|--------|--------|--------|--------|
| | | COM | 2 | 3 | 4 | 5 | 6 | 7 | 8 | 9 | 10 | 11 | 12 |
|  <p>High Back Three Seat Chair Half Center Arms COM Yardage: 5.75 Freight Class: 300 Product Weight (lbs.): 148 Cubic Feet Per Carton: 80.75</p> | GC4235HB | \$2977 | \$3109 | \$3219 | \$3380 | \$3609 | \$3696 | \$3895 | \$4272 | \$4461 | \$4811 | \$5297 | \$5896 |
| | | OVERALL DIMENSIONS W D H | | | SEAT DIMENSIONS W D H | | | BACK DIMENSIONS W H | | | | | |
| | | 74.5 | 26 | 42.5 | 22 | 18 | 18 | 21.5 | 24.5 | | | | |

Wood armcap option - Add \$235

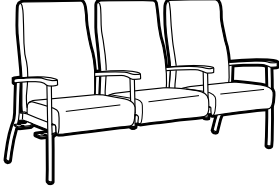
| | | | | | | | | | | | | | |
|---|-----------|------------------------------------|--------|--------|---------------------------------|--------|--------|-------------------------------|--------|--------|--------|--------|--------|
|  <p>High Back Three Seat Chair Half Center Arms, Right COM Yardage: 5.75 Freight Class: 300 Product Weight (lbs.): 159 Cubic Feet Per Carton: 80.75</p> | GC4235HBR | \$3005 | \$3139 | \$3246 | \$3408 | \$3636 | \$3724 | \$3923 | \$4300 | \$4489 | \$4838 | \$5325 | \$5925 |
| | | OVERALL DIMENSIONS W D H | | | SEAT DIMENSIONS W D H | | | BACK DIMENSIONS W H | | | | | |
| | | 74.5 | 26 | 42.5 | 22 | 18 | 18 | 21.5 | 24.5 | | | | |

Wood armcap option - Add \$235

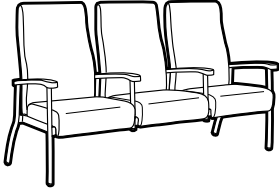
| | | | | | | | | | | | | | |
|---|-----------|------------------------------------|--------|--------|---------------------------------|--------|--------|-------------------------------|--------|--------|--------|--------|--------|
|  <p>High Back Three Seat Chair Half Center Arms, Left COM Yardage: 5.75 Freight Class: 300 Product Weight (lbs.): 159 Cubic Feet Per Carton: 80.75</p> | GC4235HBL | \$3005 | \$3139 | \$3246 | \$3408 | \$3636 | \$3724 | \$3923 | \$4300 | \$4489 | \$4838 | \$5325 | \$5925 |
| | | OVERALL DIMENSIONS W D H | | | SEAT DIMENSIONS W D H | | | BACK DIMENSIONS W H | | | | | |
| | | 74.5 | 26 | 42.5 | 22 | 18 | 18 | 21.5 | 24.5 | | | | |

Wood armcap option - Add \$235

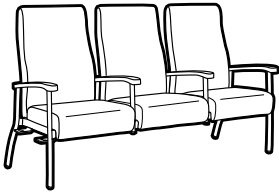
| | | | | | | | | | | | | | |
|--|-----------|------------------------------------|--------|--------|---------------------------------|--------|--------|-------------------------------|--------|--------|--------|--------|--------|
|  <p>High Back Three Seat Chair Half Center Arms, Left & Right COM Yardage: 5.75 Freight Class: 300 Product Weight (lbs.): 150 Cubic Feet Per Carton: 80.75</p> | GC4235HBB | \$3034 | \$3168 | \$3277 | \$3438 | \$3666 | \$3753 | \$3953 | \$4329 | \$4518 | \$4868 | \$5354 | \$5954 |
| | | OVERALL DIMENSIONS W D H | | | SEAT DIMENSIONS W D H | | | BACK DIMENSIONS W H | | | | | |
| | | 74.5 | 26 | 42.5 | 22 | 18 | 18 | 21.5 | 24.5 | | | | |

Wood armcap option - Add \$235

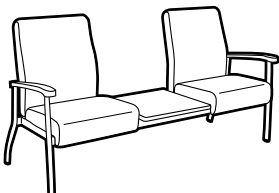
| | | | | | | | | | | | | | |
|---|--------|------------------------------------|--------|--------|---------------------------------|--------|--------|-------------------------------|--------|--------|--------|--------|--------|
|  <p>Low Back Two Seat Chair with Table Center Table Top, No Center Arms COM Yardage: 3.5 Freight Class: 300 Product Weight (lbs.): 106 Cubic Feet Per Carton: 65.25</p> | GC4236 | \$2244 | \$2326 | \$2391 | \$2490 | \$2629 | \$2682 | \$2803 | \$3033 | \$3147 | \$3360 | \$3656 | \$4022 |
| | | OVERALL DIMENSIONS W D H | | | SEAT DIMENSIONS W D H | | | BACK DIMENSIONS W H | | | | | |
| | | 72.75 | 26 | 37.5 | 44 | 18 | 18 | 44 | 19.5 | | | | |

Wood armcap option - Add \$118

• Table top only offered in High Pressure Laminate

SEATING

GC-BELONG G

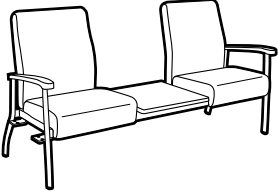
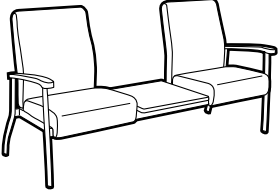
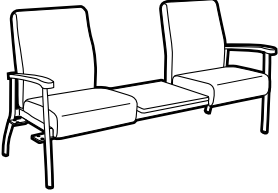
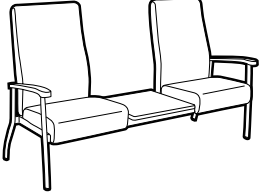
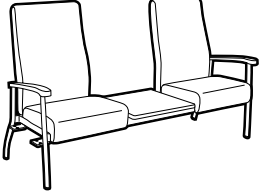
| DESCRIPTION | MODEL# | STANDARD FABRIC GRADES | | | | | | | | | | | |
|---|---------------------------|------------------------|--------|------------------------|--------|--------|------------------------|--------|--------|--------|--------|--------|--------|
| | | COM | 2 | 3 | 4 | 5 | 6 | 7 | 8 | 9 | 10 | 11 | 12 |
|  <p>Low Back Two Seat Chair with Table Center Table Top, No Center Arms, Right COM Yardage: 3.5 Freight Class: 300 Product Weight (lbs.): 107 Cubic Feet Per Carton: 65.25</p> <p>Wood armcap option - Add \$118</p> <p>• Table top only offered in High Pressure Laminate</p> | GC4236R | \$2272 | \$2354 | \$2420 | \$2518 | \$2657 | \$2710 | \$2832 | \$3061 | \$3176 | \$3388 | \$3685 | \$4050 |
| | OVERALL DIMENSIONS | | | SEAT DIMENSIONS | | | BACK DIMENSIONS | | | | | | |
| | W | D | H | W | D | H | W | H | | | | | |
| | 72.75 | 26 | 37.5 | 44 | 18 | 18 | 44 | 19.5 | | | | | |
|  <p>Low Back Two Seat Chair with Table Center Table Top, No Center Arms, Left COM Yardage: 3.5 Freight Class: 300 Product Weight (lbs.): 107 Cubic Feet Per Carton: 65.25</p> <p>Wood armcap option - Add \$118</p> <p>• Table top only offered in High Pressure Laminate</p> | GC4236L | \$2272 | \$2354 | \$2420 | \$2518 | \$2657 | \$2710 | \$2832 | \$3061 | \$3176 | \$3388 | \$3685 | \$4050 |
| | OVERALL DIMENSIONS | | | SEAT DIMENSIONS | | | BACK DIMENSIONS | | | | | | |
| | W | D | H | W | D | H | W | H | | | | | |
| | 72.75 | 26 | 37.5 | 44 | 18 | 18 | 44 | 19.5 | | | | | |
|  <p>Low Back Two Seat Chair with Table Center Table Top, No Center Arms, Left & Right COM Yardage: 3.5 Freight Class: 300 Product Weight (lbs.): 108 Cubic Feet Per Carton: 65.25</p> <p>Wood armcap option - Add \$118</p> <p>• Table top only offered in High Pressure Laminate</p> | GC4236B | \$2298 | \$2380 | \$2446 | \$2544 | \$2683 | \$2736 | \$2858 | \$3087 | \$3201 | \$3415 | \$3710 | \$4076 |
| | OVERALL DIMENSIONS | | | SEAT DIMENSIONS | | | BACK DIMENSIONS | | | | | | |
| | W | D | H | W | D | H | W | H | | | | | |
| | 72.75 | 26 | 37.5 | 44 | 18 | 18 | 44 | 19.5 | | | | | |
|  <p>High Back Two Seat Chair with Table Center Table Top, No Center Arms COM Yardage: 4 Freight Class: 300 Product Weight (lbs.): 110 Cubic Feet Per Carton: 80.75</p> <p>Wood armcap option - Add \$118</p> <p>• Table top only offered in High Pressure Laminate</p> | GC4236HB | \$2436 | \$2529 | \$2605 | \$2717 | \$2876 | \$2937 | \$3076 | \$3338 | \$3469 | \$3712 | \$4050 | \$4468 |
| | OVERALL DIMENSIONS | | | SEAT DIMENSIONS | | | BACK DIMENSIONS | | | | | | |
| | W | D | H | W | D | H | W | H | | | | | |
| | 72.75 | 26 | 42.5 | 44 | 18 | 18 | 44 | 24.5 | | | | | |
|  <p>High Back Two Seat Chair with Table Center Table Top, No Center Arms, Right COM Yardage: 4 Freight Class: 300 Product Weight (lbs.): 111 Cubic Feet Per Carton: 80.75</p> <p>Wood armcap option - Add \$118</p> <p>• Table top only offered in High Pressure Laminate</p> | GC4236HBR | \$2464 | \$2557 | \$2632 | \$2745 | \$2904 | \$2964 | \$3103 | \$3364 | \$3496 | \$3740 | \$4077 | \$4495 |
| | OVERALL DIMENSIONS | | | SEAT DIMENSIONS | | | BACK DIMENSIONS | | | | | | |
| | W | D | H | W | D | H | W | H | | | | | |
| | 72.75 | 26 | 42.5 | 44 | 18 | 18 | 44 | 24.5 | | | | | |

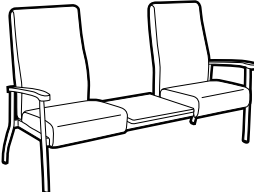
| DESCRIPTION | MODEL# | STANDARD FABRIC GRADES | | | | | | | | | | | |
|--|------------------|------------------------|------------------------------------|--------|--------|---------------------------------|--------|--------|-------------------------------|--------|--------|--------|--------|
| | | COM | 2 | 3 | 4 | 5 | 6 | 7 | 8 | 9 | 10 | 11 | 12 |
|  <p>High Back Two Seat Chair with Table Center Table Top, No Center Arms, Left COM Yardage: 4 Freight Class: 300 Product Weight (lbs.): 111 Cubic Feet Per Carton: 80.75</p> <p>Wood armcap option - Add \$118</p> <ul style="list-style-type: none"> Table top only offered in High Pressure Laminate | GC4236HBL | \$2464 | \$2557 | \$2632 | \$2745 | \$2904 | \$2964 | \$3103 | \$3364 | \$3496 | \$3740 | \$4077 | \$4495 |
| | | | OVERALL DIMENSIONS W D H | | | SEAT DIMENSIONS W D H | | | BACK DIMENSIONS W H | | | | |
| | | 72.75 | 26 | 42.5 | 44 | 18 | 18 | 44 | 24.5 | | | | |

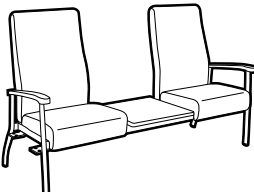
| | | | | | | | | | | | | | |
|--|------------------|--------|------------------------------------|--------|--------|---------------------------------|--------|--------|-------------------------------|--------|--------|--------|--------|
|  <p>High Back Two Seat Chair with Table Center Table Top, No Center Arms, Left & Right COM Yardage: 4 Freight Class: 300 Product Weight (lbs.): 118 Cubic Feet Per Carton: 80.75</p> <p>Wood armcap option - Add \$118</p> <ul style="list-style-type: none"> Table top only offered in High Pressure Laminate | GC4236HBB | \$2492 | \$2585 | \$2660 | \$2773 | \$2932 | \$2991 | \$3131 | \$3393 | \$3524 | \$3768 | \$4105 | \$4523 |
| | | | OVERALL DIMENSIONS W D H | | | SEAT DIMENSIONS W D H | | | BACK DIMENSIONS W H | | | | |
| | | 72.75 | 26 | 42.5 | 44 | 18 | 18 | 44 | 24.5 | | | | |

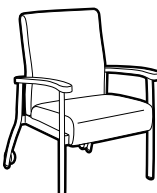
| | | | | | | | | | | | | | |
|---|---------------|--------|------------------------------------|--------|--------|---------------------------------|--------|--------|-------------------------------|--------|--------|--------|--------|
|  <p>Low Back Armchair Casters COM Yardage: 1.75 Freight Class: 250 Product Weight (lbs.): 49 Cubic Feet Per Carton: 20.25</p> <p>Wood armcap option - Add \$118</p> | GC4240 | \$1259 | \$1299 | \$1333 | \$1382 | \$1451 | \$1478 | \$1539 | \$1654 | \$1710 | \$1817 | \$1965 | \$2148 |
| | | | OVERALL DIMENSIONS W D H | | | SEAT DIMENSIONS W D H | | | BACK DIMENSIONS W H | | | | |
| | | 26.75 | 27.5 | 37.5 | 22 | 18 | 18 | 21.5 | 19.5 | | | | |

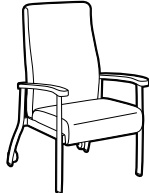
| | | | | | | | | | | | | | |
|--|-----------------|--------|------------------------------------|--------|--------|---------------------------------|--------|--------|-------------------------------|--------|--------|--------|--------|
|  <p>High Back Armchair Casters COM Yardage: 2 Freight Class: 250 Product Weight (lbs.): 54 Cubic Feet Per Carton: 22.25</p> <p>Wood armcap option - Add \$118</p> | GC4240HB | \$1306 | \$1352 | \$1389 | \$1446 | \$1525 | \$1555 | \$1625 | \$1756 | \$1822 | \$1943 | \$2112 | \$2321 |
| | | | OVERALL DIMENSIONS W D H | | | SEAT DIMENSIONS W D H | | | BACK DIMENSIONS W H | | | | |
| | | 26.75 | 27.5 | 42.5 | 22 | 18 | 18 | 21.5 | 24.5 | | | | |

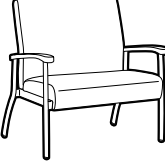
| | | | | | | | | | | | | | |
|--|---------------|--------|------------------------------------|--------|--------|---------------------------------|--------|--------|-------------------------------|--------|--------|--------|--------|
|  <p>Bariatric Low Back Armchair COM Yardage: 3 Freight Class: 250 Product Weight (lbs.): 69 Cubic Feet Per Carton: 30.50</p> <p>Wood armcap option - Add \$118</p> <ul style="list-style-type: none"> For users up to 750 lbs. Armless Bariatric models are <u>not</u> available. | GC4241 | \$1453 | \$1523 | \$1579 | \$1664 | \$1783 | \$1828 | \$1933 | \$2129 | \$2227 | \$2410 | \$2663 | \$2977 |
| | | | OVERALL DIMENSIONS W D H | | | SEAT DIMENSIONS W D H | | | BACK DIMENSIONS W H | | | | |
| | | 37.5 | 26 | 37.5 | 32.5 | 18 | 18 | 32.5 | 19.5 | | | | |

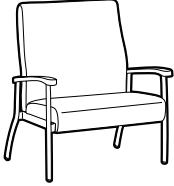
| DESCRIPTION | MODEL# | STANDARD FABRIC GRADES | | | | | | | | | | | |
|---|-----------|---------------------------|--------|--------|------------------------|--------|--------|------------------------|--------|--------|--------|--------|--------|
| | | COM | 2 | 3 | 4 | 5 | 6 | 7 | 8 | 9 | 10 | 11 | 12 |
|  | GC4241HBL | \$1683 | \$1758 | \$1820 | \$1911 | \$2040 | \$2089 | \$2202 | \$2414 | \$2521 | \$2720 | \$2993 | \$3333 |
| | | OVERALL DIMENSIONS | | | SEAT DIMENSIONS | | | BACK DIMENSIONS | | | | | |
| | | W | D | H | W | D | H | W | H | | | | |
| | | 37.5 | 26 | 42.5 | 32.5 | 18 | 18 | 32.5 | 24.5 | | | | |

Bariatric High Back Armchair Left
 COM Yardage: 3.25
 Freight Class: 250
 Product Weight (lbs.): 72
 Cubic Feet Per Carton: 30.50

Wood armcap option - **Add \$118**
 • **For users up to 750 lbs.**
 Armless Bariatric models are not available.

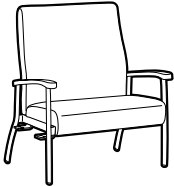
| DESCRIPTION | MODEL# | STANDARD FABRIC GRADES | | | | | | | | | | | |
|---|-----------|---------------------------|--------|--------|------------------------|--------|--------|------------------------|--------|--------|--------|--------|--------|
| | | COM | 2 | 3 | 4 | 5 | 6 | 7 | 8 | 9 | 10 | 11 | 12 |
|  | GC4241HBB | \$1713 | \$1788 | \$1850 | \$1941 | \$2071 | \$2120 | \$2233 | \$2445 | \$2551 | \$2750 | \$3025 | \$3363 |
| | | OVERALL DIMENSIONS | | | SEAT DIMENSIONS | | | BACK DIMENSIONS | | | | | |
| | | W | D | H | W | D | H | W | H | | | | |
| | | 37.5 | 26 | 42.5 | 32.5 | 18 | 18 | 32.5 | 24.5 | | | | |

Bariatric High Back Armchair Left & Right
 COM Yardage: 3.25
 Freight Class: 250
 Product Weight (lbs.): 73
 Cubic Feet Per Carton: 30.50

Wood armcap option - **Add \$118**
 • **For users up to 750 lbs.**
 Armless Bariatric models are not available.

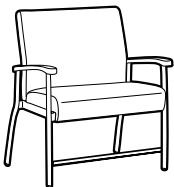
| DESCRIPTION | MODEL# | STANDARD FABRIC GRADES | | | | | | | | | | | |
|--|------------------------------|---------------------------|--------|--------|------------------------|--------|--------|------------------------|--------|--------|--------|--------|--------|
| | | COM | 2 | 3 | 4 | 5 | 6 | 7 | 8 | 9 | 10 | 11 | 12 |
|  | GC4241-24 24" Seat Height | \$1697 | \$1767 | \$1823 | \$1908 | \$2027 | \$2072 | \$2176 | \$2373 | \$2471 | \$2654 | \$2908 | \$3220 |
| | | OVERALL DIMENSIONS | | | SEAT DIMENSIONS | | | BACK DIMENSIONS | | | | | |
| | | W | D | H | W | D | H | W | H | | | | |
| | | 37.5 | 26 | 43.5 | 32.5 | 18 | 24 | 32.5 | 19.5 | | | | |

Bariatric Low Back Armchair Post Surgery. Designed to immobilize the pelvis and hip joints after surgery.
 COM Yardage: 3
 Freight Class: 250
 Product Weight (lbs.): 74
 Cubic Feet Per Carton: 33.50

Wood armcap option - **Add \$118**
 • **For users up to 750 lbs.**
 Armless Bariatric models are not available.

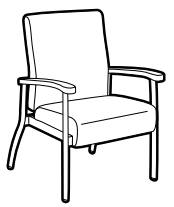
| DESCRIPTION | MODEL# | STANDARD FABRIC GRADES | | | | | | | | | | | |
|---|--------|---------------------------|--------|--------|------------------------|--------|--------|------------------------|--------|--------|--------|--------|--------|
| | | COM | 2 | 3 | 4 | 5 | 6 | 7 | 8 | 9 | 10 | 11 | 12 |
|  | GC4242 | \$1501 | \$1542 | \$1575 | \$1624 | \$1693 | \$1721 | \$1781 | \$1896 | \$1953 | \$2059 | \$2208 | \$2390 |
| | | OVERALL DIMENSIONS | | | SEAT DIMENSIONS | | | BACK DIMENSIONS | | | | | |
| | | W | D | H | W | D | H | W | H | | | | |
| | | 26.75 | 26 | 37.5 | 22 | 18 | 18 | 21.5 | 19.5 | | | | |

Low Back Armchair Flex Back
 COM Yardage: 1.75
 Freight Class: 250
 Product Weight (lbs.): 49
 Cubic Feet Per Carton: 20.25

Wood armcap option - **Add \$118**

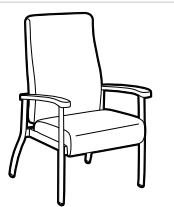
| DESCRIPTION | MODEL# | STANDARD FABRIC GRADES | | | | | | | | | | | |
|---|----------|---------------------------|--------|--------|------------------------|--------|--------|------------------------|--------|--------|--------|--------|--------|
| | | COM | 2 | 3 | 4 | 5 | 6 | 7 | 8 | 9 | 10 | 11 | 12 |
|  | GC4242HB | \$1550 | \$1595 | \$1634 | \$1690 | \$1770 | \$1800 | \$1870 | \$2001 | \$2066 | \$2188 | \$2357 | \$2566 |
| | | OVERALL DIMENSIONS | | | SEAT DIMENSIONS | | | BACK DIMENSIONS | | | | | |
| | | W | D | H | W | D | H | W | H | | | | |
| | | 26.75 | 26 | 42.5 | 22 | 18 | 18 | 21.5 | 24.5 | | | | |

High Back Armchair Flex Back
 COM Yardage: 2
 Freight Class: 250
 Product Weight (lbs.): 51
 Cubic Feet Per Carton: 22.25

Wood armcap option - **Add \$118**

| DESCRIPTION | MODEL# | STANDARD FABRIC GRADES | | | | | | | | | | | |
|-------------|--------|------------------------|---|---|---|---|---|---|---|---|----|----|----|
| | | COM | 2 | 3 | 4 | 5 | 6 | 7 | 8 | 9 | 10 | 11 | 12 |



Single Seat Bench Left
 COM Yardage: 1.5
 Freight Class: 250
 Product Weight (lbs.): 31
 Cubic Feet Per Carton: 13

GC4251L

| | | | | | | | | | | | |
|-------|-------|-------|-------|-------|-------|--------|--------|--------|--------|--------|--------|
| \$766 | \$801 | \$829 | \$872 | \$932 | \$954 | \$1006 | \$1104 | \$1153 | \$1245 | \$1372 | \$1528 |
|-------|-------|-------|-------|-------|-------|--------|--------|--------|--------|--------|--------|

| OVERALL DIMENSIONS | | | SEAT DIMENSIONS | | | BACK DIMENSIONS | |
|--------------------|------|----|-----------------|---|---|-----------------|---|
| W | D | H | W | D | H | W | H |
| 25.75 | 26.5 | 18 | | | | | |

| DESCRIPTION | MODEL# | STANDARD FABRIC GRADES | | | | | | | | | | | |
|-------------|--------|------------------------|---|---|---|---|---|---|---|---|----|----|----|
| | | COM | 2 | 3 | 4 | 5 | 6 | 7 | 8 | 9 | 10 | 11 | 12 |

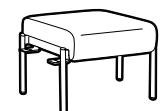

Single Seat Bench Left & Right
 COM Yardage: 1.5
 Freight Class: 250
 Product Weight (lbs.): 32
 Cubic Feet Per Carton: 13

GC4251B

| | | | | | | | | | | | |
|-------|-------|-------|-------|-------|-------|--------|--------|--------|--------|--------|--------|
| \$797 | \$831 | \$859 | \$902 | \$962 | \$984 | \$1036 | \$1134 | \$1183 | \$1275 | \$1402 | \$1559 |
|-------|-------|-------|-------|-------|-------|--------|--------|--------|--------|--------|--------|

| OVERALL DIMENSIONS | | | SEAT DIMENSIONS | | | BACK DIMENSIONS | |
|--------------------|------|----|-----------------|---|---|-----------------|---|
| W | D | H | W | D | H | W | H |
| 26.75 | 26.5 | 18 | | | | | |

| DESCRIPTION | MODEL# | STANDARD FABRIC GRADES | | | | | | | | | | | |
|-------------|--------|------------------------|---|---|---|---|---|---|---|---|----|----|----|
| | | COM | 2 | 3 | 4 | 5 | 6 | 7 | 8 | 9 | 10 | 11 | 12 |

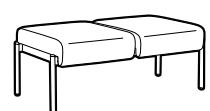

Two Seat Bench
 COM Yardage: 2.25
 Freight Class: 250
 Product Weight (lbs.): 53
 Cubic Feet Per Carton: 23

GC4252

| | | | | | | | | | | | |
|--------|--------|--------|--------|--------|--------|--------|--------|--------|--------|--------|--------|
| \$1343 | \$1396 | \$1438 | \$1501 | \$1591 | \$1624 | \$1703 | \$1850 | \$1924 | \$2061 | \$2251 | \$2487 |
|--------|--------|--------|--------|--------|--------|--------|--------|--------|--------|--------|--------|

| OVERALL DIMENSIONS | | | SEAT DIMENSIONS | | | BACK DIMENSIONS | |
|--------------------|------|----|-----------------|---|---|-----------------|---|
| W | D | H | W | D | H | W | H |
| 47.75 | 26.5 | 18 | | | | | |

| DESCRIPTION | MODEL# | STANDARD FABRIC GRADES | | | | | | | | | | | |
|-------------|--------|------------------------|---|---|---|---|---|---|---|---|----|----|----|
| | | COM | 2 | 3 | 4 | 5 | 6 | 7 | 8 | 9 | 10 | 11 | 12 |

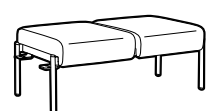

Two Seat Bench Left
 COM Yardage: 2.25
 Freight Class: 250
 Product Weight (lbs.): 54
 Cubic Feet Per Carton: 23

GC4252L

| | | | | | | | | | | | |
|--------|--------|--------|--------|--------|--------|--------|--------|--------|--------|--------|--------|
| \$1374 | \$1426 | \$1469 | \$1531 | \$1621 | \$1655 | \$1733 | \$1880 | \$1955 | \$2092 | \$2282 | \$2517 |
|--------|--------|--------|--------|--------|--------|--------|--------|--------|--------|--------|--------|

| OVERALL DIMENSIONS | | | SEAT DIMENSIONS | | | BACK DIMENSIONS | |
|--------------------|------|----|-----------------|---|---|-----------------|---|
| W | D | H | W | D | H | W | H |
| 48.75 | 26.5 | 18 | | | | | |

| DESCRIPTION | MODEL# | STANDARD FABRIC GRADES | | | | | | | | | | | |
|-------------|--------|------------------------|---|---|---|---|---|---|---|---|----|----|----|
| | | COM | 2 | 3 | 4 | 5 | 6 | 7 | 8 | 9 | 10 | 11 | 12 |

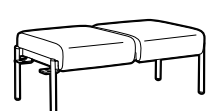

Two Seat Bench Left & Right
 COM Yardage: 2.25
 Freight Class: 250
 Product Weight (lbs.): 55
 Cubic Feet Per Carton: 23

GC4252B

| | | | | | | | | | | | |
|--------|--------|--------|--------|--------|--------|--------|--------|--------|--------|--------|--------|
| \$1404 | \$1456 | \$1499 | \$1562 | \$1652 | \$1685 | \$1763 | \$1911 | \$1985 | \$2122 | \$2312 | \$2547 |
|--------|--------|--------|--------|--------|--------|--------|--------|--------|--------|--------|--------|

| OVERALL DIMENSIONS | | | SEAT DIMENSIONS | | | BACK DIMENSIONS | |
|--------------------|------|----|-----------------|---|---|-----------------|---|
| W | D | H | W | D | H | W | H |
| 49.75 | 26.5 | 18 | | | | | |

SEATING

| DESCRIPTION | MODEL# | STANDARD FABRIC GRADES | | | | | | | | | | | |
|-------------|--------|------------------------|---|---|---|---|---|---|---|---|----|----|----|
| | | COM | 2 | 3 | 4 | 5 | 6 | 7 | 8 | 9 | 10 | 11 | 12 |

| | | | | | | | | | | | | | |
|--|--------|--------|--------|--------|--------|--------|--------|--------|--------|--------|--------|--------|--------|
| | GC4253 | \$1970 | \$2040 | \$2097 | \$2181 | \$2301 | \$2345 | \$2450 | \$2646 | \$2745 | \$2928 | \$3181 | \$3494 |
|--|--------|--------|--------|--------|--------|--------|--------|--------|--------|--------|--------|--------|--------|

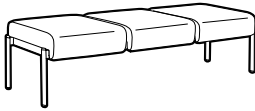

Three Seat Bench

COM Yardage: 3
 Freight Class: 250
 Product Weight (lbs.): 73
 Cubic Feet Per Carton: 33.25

| OVERALL DIMENSIONS | | | SEAT DIMENSIONS | | | BACK DIMENSIONS | |
|--------------------|------|----|-----------------|---|---|-----------------|---|
| W | D | H | W | D | H | W | H |
| 70.75 | 26.5 | 18 | | | | | |

| | | | | | | | | | | | | | |
|--|---------|--------|--------|--------|--------|--------|--------|--------|--------|--------|--------|--------|--------|
| | GC4253L | \$2001 | \$2071 | \$2127 | \$2212 | \$2331 | \$2376 | \$2480 | \$2677 | \$2775 | \$2958 | \$3212 | \$3524 |
|--|---------|--------|--------|--------|--------|--------|--------|--------|--------|--------|--------|--------|--------|

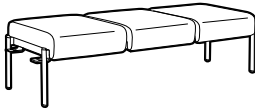

Three Seat Bench Left

COM Yardage: 3
 Freight Class: 250
 Product Weight (lbs.): 74
 Cubic Feet Per Carton: 33.25

| OVERALL DIMENSIONS | | | SEAT DIMENSIONS | | | BACK DIMENSIONS | |
|--------------------|------|----|-----------------|---|---|-----------------|---|
| W | D | H | W | D | H | W | H |
| 71.75 | 26.5 | 18 | | | | | |

| | | | | | | | | | | | | | |
|--|---------|--------|--------|--------|--------|--------|--------|--------|--------|--------|--------|--------|--------|
| | GC4253B | \$2032 | \$2101 | \$2157 | \$2242 | \$2361 | \$2406 | \$2511 | \$2707 | \$2805 | \$2988 | \$3242 | \$3556 |
|--|---------|--------|--------|--------|--------|--------|--------|--------|--------|--------|--------|--------|--------|

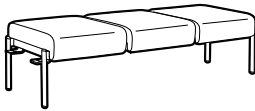

Three Seat Bench Left & Right

COM Yardage: 3
 Freight Class: 250
 Product Weight (lbs.): 75
 Cubic Feet Per Carton: 33.25

| OVERALL DIMENSIONS | | | SEAT DIMENSIONS | | | BACK DIMENSIONS | |
|--------------------|------|----|-----------------|---|---|-----------------|---|
| W | D | H | W | D | H | W | H |
| 72.75 | 26.5 | 18 | | | | | |

| | | | | | | | | | | | | | |
|--|--------|--------|--------|--------|--------|--------|--------|--------|--------|--------|--------|--------|--------|
| | GC4256 | \$1919 | \$1971 | \$2014 | \$2077 | \$2167 | \$2200 | \$2279 | \$2426 | \$2500 | \$2637 | \$2827 | \$3062 |
|--|--------|--------|--------|--------|--------|--------|--------|--------|--------|--------|--------|--------|--------|

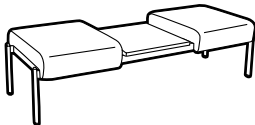

Two Seat Bench with Table Center Table Top

COM Yardage: 2.25
 Freight Class: 250
 Product Weight (lbs.): 73
 Cubic Feet Per Carton: 33.25

• Table top only offered in High Pressure Laminate

| OVERALL DIMENSIONS | | | SEAT DIMENSIONS | | | BACK DIMENSIONS | |
|--------------------|------|----|-----------------|---|---|-----------------|---|
| W | D | H | W | D | H | W | H |
| 70.75 | 26.5 | 18 | | | | | |

| | | | | | | | | | | | | | |
|--|---------|--------|--------|--------|--------|--------|--------|--------|--------|--------|--------|--------|--------|
| | GC4256L | \$1949 | \$2002 | \$2045 | \$2107 | \$2197 | \$2231 | \$2309 | \$2456 | \$2530 | \$2667 | \$2858 | \$3093 |
|--|---------|--------|--------|--------|--------|--------|--------|--------|--------|--------|--------|--------|--------|

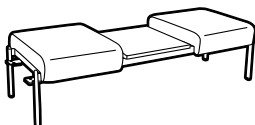

Two Seat Bench with Table Center Table Top, Left

COM Yardage: 2.25
 Freight Class: 250
 Product Weight (lbs.): 68
 Cubic Feet Per Carton: 33.25

• Table top only offered in High Pressure Laminate

| OVERALL DIMENSIONS | | | SEAT DIMENSIONS | | | BACK DIMENSIONS | |
|--------------------|------|----|-----------------|---|---|-----------------|---|
| W | D | H | W | D | H | W | H |
| 71.75 | 26.5 | 18 | | | | | |

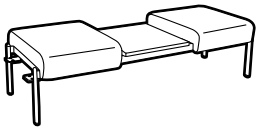
| DESCRIPTION | MODEL# | STANDARD FABRIC GRADES | | | | | | | | | | | | |
|--|---------|------------------------|--------|--------|-----------------|--------|--------|-----------------|--------|--------|--------|--------|--------|--|
| | | COM | 2 | 3 | 4 | 5 | 6 | 7 | 8 | 9 | 10 | 11 | 12 | |
|  <p>Two Seat Bench with Table Center Table Top, Left & Right COM Yardage: 2.25 Freight Class: 250 Product Weight (lbs.): 70 Cubic Feet Per Carton: 33.25</p> | GC4256B | \$1980 | \$2032 | \$2075 | \$2138 | \$2227 | \$2261 | \$2339 | \$2487 | \$2561 | \$2698 | \$2888 | \$3123 | |
| | | OVERALL DIMENSIONS | | | SEAT DIMENSIONS | | | BACK DIMENSIONS | | | | | | |
| | | W | D | H | W | D | H | W | H | | | | | |
| | | | 72.75 | 26.5 | 18 | | | | | | | | | |

• Table top only offered in High Pressure Laminate

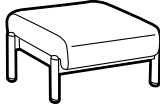
| DESCRIPTION | MODEL# | STANDARD FABRIC GRADES | | | | | | | | | | | | |
|---|--------|------------------------|-------|-------|-----------------|-------|-------|-----------------|-------|-------|-------|-------|--------|--|
| | | COM | 2 | 3 | 4 | 5 | 6 | 7 | 8 | 9 | 10 | 11 | 12 | |
|  <p>Ottoman Angled cushion top. COM Yardage: 1 Freight Class: 150 Product Weight (lbs.): 16 Cubic Feet Per Carton: 3.60</p> | GC4259 | \$548 | \$571 | \$590 | \$618 | \$658 | \$673 | \$708 | \$774 | \$806 | \$867 | \$951 | \$1056 | |
| | | OVERALL DIMENSIONS | | | SEAT DIMENSIONS | | | BACK DIMENSIONS | | | | | | |
| | | W | D | H | W | D | H | W | H | | | | | |
| | | | 17.75 | 19 | 10.5 | | | | | | | | | |

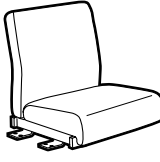
| DESCRIPTION | MODEL# | STANDARD FABRIC GRADES | | | | | | | | | | | |
|--|--------|------------------------|-------|-------|-----------------|-------|-------|-----------------|--------|--------|--------|--------|--------|
| | | COM | 2 | 3 | 4 | 5 | 6 | 7 | 8 | 9 | 10 | 11 | 12 |
|  <p>Low Back Single Seat Armless Bridge Left & Right COM Yardage: 1.75 Freight Class: 250 Product Weight (lbs.): 36 Cubic Feet Per Carton: 13</p> | GC4261 | \$768 | \$808 | \$842 | \$891 | \$960 | \$987 | \$1048 | \$1163 | \$1219 | \$1326 | \$1474 | \$1657 |
| | | OVERALL DIMENSIONS | | | SEAT DIMENSIONS | | | BACK DIMENSIONS | | | | | |
| | | W | D | H | W | D | H | W | H | | | | |
| | | | 26.75 | 24 | 25.5 | 22 | 18 | -- | 21.5 | 19.5 | | | |

Not freestanding.
 Suspends between 2 units via linking brackets.

| DESCRIPTION | MODEL# | STANDARD FABRIC GRADES | | | | | | | | | | | |
|--|----------|------------------------|-------|-------|-----------------|--------|--------|-----------------|--------|--------|--------|--------|--------|
| | | COM | 2 | 3 | 4 | 5 | 6 | 7 | 8 | 9 | 10 | 11 | 12 |
|  <p>High Back Single Seat Armless Bridge Left & Right COM Yardage: 2 Freight Class: 250 Product Weight (lbs.): 41 Cubic Feet Per Carton: 14.50</p> | GC4261HB | \$811 | \$857 | \$895 | \$951 | \$1031 | \$1061 | \$1131 | \$1262 | \$1328 | \$1449 | \$1618 | \$1827 |
| | | OVERALL DIMENSIONS | | | SEAT DIMENSIONS | | | BACK DIMENSIONS | | | | | |
| | | W | D | H | W | D | H | W | H | | | | |
| | | | 26.75 | 24 | 30.5 | 22 | 18 | -- | 21.5 | 24.5 | | | |

Not freestanding.
 Suspends between 2 units via linking brackets.

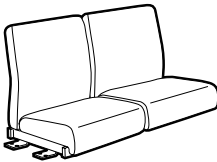
| DESCRIPTION | MODEL# | STANDARD FABRIC GRADES | | | | | | | | | | | |
|---|--------|------------------------|--------|--------|-----------------|--------|--------|-----------------|--------|--------|--------|--------|--------|
| | | COM | 2 | 3 | 4 | 5 | 6 | 7 | 8 | 9 | 10 | 11 | 12 |
|  <p>Low Back Two Seat Armless Bridge Left & Right COM Yardage: 3.5 Freight Class: 250 Product Weight (lbs.): 66 Cubic Feet Per Carton: 23</p> | GC4262 | \$1472 | \$1553 | \$1619 | \$1717 | \$1856 | \$1910 | \$2031 | \$2261 | \$2376 | \$2588 | \$2884 | \$3249 |
| | | OVERALL DIMENSIONS | | | SEAT DIMENSIONS | | | BACK DIMENSIONS | | | | | |
| | | W | D | H | W | D | H | W | H | | | | |
| | | | 49.75 | 24 | 25.5 | 44 | 18 | -- | 44 | 19.5 | | | |

Not freestanding.
 Suspends between 2 units via linking brackets.

SEATING

GC-BELONG G

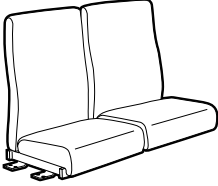
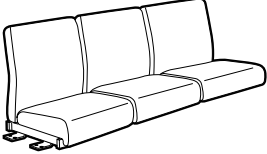
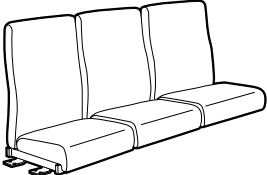
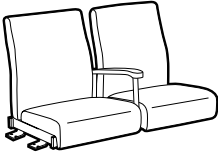
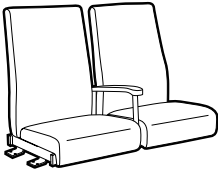
| DESCRIPTION | MODEL# | STANDARD FABRIC GRADES | | | | | | | | | | | |
|--|----------|--|--------|--------|------------------------|--------|--------|------------------------|--------|--------|--------|--------|--------|
| | | COM | 2 | 3 | 4 | 5 | 6 | 7 | 8 | 9 | 10 | 11 | 12 |
|  <p>High Back Two Seat Armless Bridge Left & Right COM Yardage: 4 Freight Class: 250 Product Weight (lbs.): 72 Cubic Feet Per Carton: 24</p> | GC4262HB | \$1560 | \$1653 | \$1728 | \$1841 | \$2000 | \$2060 | \$2199 | \$2460 | \$2592 | \$2836 | \$3173 | \$3591 |
| | | OVERALL DIMENSIONS | | | SEAT DIMENSIONS | | | BACK DIMENSIONS | | | | | |
| | | W | D | H | W | D | H | W | H | | | | |
| | | | 49.75 | 24 | 30.5 | 44 | 18 | -- | 44 | 24.5 | | | |
| | | Not freestanding. Suspends between 2 units via linking brackets. | | | | | | | | | | | |
|  <p>Low Back Three Seat Armless Bridge Left & Right COM Yardage: 5 Freight Class: 300 Product Weight (lbs.): 74 Cubic Feet Per Carton: 38.75</p> | GC4263 | \$2143 | \$2259 | \$2353 | \$2494 | \$2692 | \$2768 | \$2941 | \$3269 | \$3432 | \$3737 | \$4160 | \$4682 |
| | | OVERALL DIMENSIONS | | | SEAT DIMENSIONS | | | BACK DIMENSIONS | | | | | |
| | | W | D | H | W | D | H | W | H | | | | |
| | | | 72.75 | 24 | 25.5 | 70 | 18 | -- | 70 | 19.5 | | | |
| | | Not freestanding. Suspends between 2 units via linking brackets. | | | | | | | | | | | |
|  <p>High Back Three Seat Armless Bridge Left & Right COM Yardage: 5.75 Freight Class: 250 Product Weight (lbs.): 80 Cubic Feet Per Carton: 38.75</p> | GC4263HB | \$2286 | \$2420 | \$2528 | \$2689 | \$2918 | \$3005 | \$3204 | \$3581 | \$3770 | \$4120 | \$4606 | \$5206 |
| | | OVERALL DIMENSIONS | | | SEAT DIMENSIONS | | | BACK DIMENSIONS | | | | | |
| | | W | D | H | W | D | H | W | H | | | | |
| | | | 72.75 | 24 | 30.5 | 70 | 18 | -- | 70 | 24.5 | | | |
| | | Not freestanding. Suspends between 2 units via linking brackets. | | | | | | | | | | | |
|  <p>Low Back Two Seat Bridge Half Center Arm, Left & Right COM Yardage: 3.50 Freight Class: 250 Product Weight (lbs.): 58 Cubic Feet Per Carton: 27.25</p> | GC4264 | \$1770 | \$1851 | \$1917 | \$2015 | \$2154 | \$2208 | \$2329 | \$2559 | \$2673 | \$2886 | \$3181 | \$3547 |
| | | OVERALL DIMENSIONS | | | SEAT DIMENSIONS | | | BACK DIMENSIONS | | | | | |
| | | W | D | H | W | D | H | W | H | | | | |
| | | | 50.75 | 24 | 25.5 | 22 | 18 | -- | 21.5 | 19.5 | | | |
| | | Not freestanding. Suspends between 2 units via linking brackets. Wood armcap option - Add \$30 | | | | | | | | | | | |
|  <p>High Back Two Seat Bridge Half Center Arm, Left & Right COM Yardage: 4 Freight Class: 250 Product Weight (lbs.): 68 Cubic Feet Per Carton: 27.25</p> | GC4264HB | \$1865 | \$1958 | \$2033 | \$2146 | \$2305 | \$2365 | \$2504 | \$2766 | \$2897 | \$3141 | \$3478 | \$3896 |
| | | OVERALL DIMENSIONS | | | SEAT DIMENSIONS | | | BACK DIMENSIONS | | | | | |
| | | W | D | H | W | D | H | W | H | | | | |
| | | | 50.75 | 24 | 30.5 | 22 | 18 | -- | 21.5 | 24.5 | | | |
| | | Not freestanding. Suspends between 2 units via linking brackets. Wood armcap option - Add \$30 | | | | | | | | | | | |

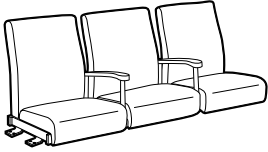

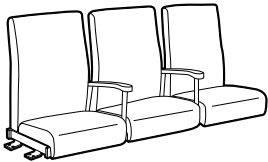
| DESCRIPTION | MODEL# | STANDARD FABRIC GRADES | | | | | | | | | | | |
|--|--------|--|--------|--------|-----------------|--------|--------|-----------------|--------|--------|--------|--------|--------|
| | | COM | 2 | 3 | 4 | 5 | 6 | 7 | 8 | 9 | 10 | 11 | 12 |
|  <p>Low Back Three Seat Bridge Half Center Arms, Left & Right COM Yardage: 5 Freight Class: 250 Product Weight (lbs.): 78 Cubic Feet Per Carton: 38.75</p> | GC4265 | COM | 2 | 3 | 4 | 5 | 6 | 7 | 8 | 9 | 10 | 11 | 12 |
| | | \$2667 | \$2783 | \$2877 | \$3017 | \$3217 | \$3292 | \$3466 | \$3794 | \$3957 | \$4262 | \$4684 | \$5207 |
| | | OVERALL DIMENSIONS | | | SEAT DIMENSIONS | | | BACK DIMENSIONS | | | | | |
| | | W | D | H | W | D | H | W | H | | | | |
| | | 74.75 | 24 | 25.5 | 22 | 18 | -- | 21.5 | 19.5 | | | | |
| | | <p>Not freestanding. Suspends between 2 units via linking brackets. Wood armcap option - Add \$59</p> | | | | | | | | | | | |

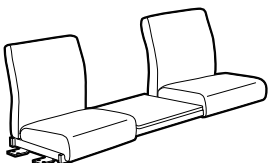
| | | | | | | | | | | | | | |
|--|----------|--|--------|--------|-----------------|--------|--------|-----------------|--------|--------|--------|--------|--------|
|  <p>High Back Three Seat Bridge Half Center Arms, Left & Right COM Yardage: 5.75 Freight Class: 250 Product Weight (lbs.): 86 Cubic Feet Per Carton: 38.75</p> | GC4265HB | COM | 2 | 3 | 4 | 5 | 6 | 7 | 8 | 9 | 10 | 11 | 12 |
| | | \$2809 | \$2943 | \$3052 | \$3213 | \$3442 | \$3528 | \$3728 | \$4104 | \$4293 | \$4643 | \$5129 | \$5729 |
| | | OVERALL DIMENSIONS | | | SEAT DIMENSIONS | | | BACK DIMENSIONS | | | | | |
| | | W | D | H | W | D | H | W | H | | | | |
| | | 74.75 | 24 | 30.5 | 22 | 18 | -- | 21.5 | 24.5 | | | | |
| | | <p>Not freestanding. Suspends between 2 units via linking brackets. Wood armcap option - Add \$59</p> | | | | | | | | | | | |

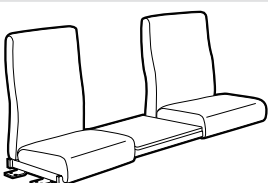
| | | | | | | | | | | | | | |
|--|--------|---|--------|--------|-----------------|--------|--------|-----------------|--------|--------|--------|--------|--------|
|  <p>Low Back Two Seat Armless Bridge Center Table Top, Left & Right COM Yardage: 3.50 Freight Class: 300 Product Weight (lbs.): 60 Cubic Feet Per Carton: 38.75</p> | GC4266 | COM | 2 | 3 | 4 | 5 | 6 | 7 | 8 | 9 | 10 | 11 | 12 |
| | | \$2172 | \$2254 | \$2319 | \$2418 | \$2557 | \$2610 | \$2731 | \$2961 | \$3075 | \$3288 | \$3584 | \$3950 |
| | | OVERALL DIMENSIONS | | | SEAT DIMENSIONS | | | BACK DIMENSIONS | | | | | |
| | | W | D | H | W | D | H | W | H | | | | |
| | | 72.75 | 24 | 25.5 | 22 | 18 | -- | 21.5 | 19.5 | | | | |
| | | <p>Not freestanding. Suspends between 2 units via linking brackets. • Table top only offered in High Pressure Laminate</p> | | | | | | | | | | | |

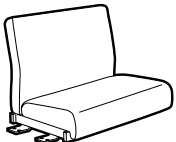
| | | | | | | | | | | | | | |
|---|----------|---|--------|--------|-----------------|--------|--------|-----------------|--------|--------|--------|--------|--------|
|  <p>High Back Two Seat Armless Bridge Center Table Top, Left & Right COM Yardage: 4 Freight Class: 300 Product Weight (lbs.): 66 Cubic Feet Per Carton: 38.75</p> | GC4266HB | COM | 2 | 3 | 4 | 5 | 6 | 7 | 8 | 9 | 10 | 11 | 12 |
| | | \$2267 | \$2360 | \$2435 | \$2548 | \$2707 | \$2767 | \$2907 | \$3168 | \$3300 | \$3543 | \$3881 | \$4299 |
| | | OVERALL DIMENSIONS | | | SEAT DIMENSIONS | | | BACK DIMENSIONS | | | | | |
| | | W | D | H | W | D | H | W | H | | | | |
| | | 72.75 | 24 | 30.5 | 22 | 18 | -- | 21.5 | 24.5 | | | | |
| | | <p>Not freestanding. Suspends between 2 units via linking brackets. • Table top only offered in High Pressure Laminate</p> | | | | | | | | | | | |

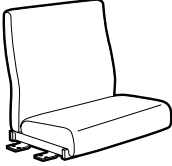
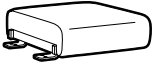
| | | | | | | | | | | | | | |
|---|--------|---|--------|--------|-----------------|--------|--------|-----------------|--------|--------|--------|--------|--------|
|  <p>Bariatric Low Back Armless Bridge Left & Right COM Yardage: 3 Freight Class: 300 Product Weight (lbs.): 44 Cubic Feet Per Carton: 26.50</p> | GC4269 | COM | 2 | 3 | 4 | 5 | 6 | 7 | 8 | 9 | 10 | 11 | 12 |
| | | \$1128 | \$1198 | \$1254 | \$1339 | \$1458 | \$1503 | \$1608 | \$1804 | \$1902 | \$2085 | \$2339 | \$2652 |
| | | OVERALL DIMENSIONS | | | SEAT DIMENSIONS | | | BACK DIMENSIONS | | | | | |
| | | W | D | H | W | D | H | W | H | | | | |
| | | 37.5 | 24 | 25.5 | 32.5 | 18 | -- | 32.5 | 19.5 | | | | |
| | | <p>Not freestanding. Suspends between 2 units via linking brackets. • For users up to 750 lbs.</p> | | | | | | | | | | | |

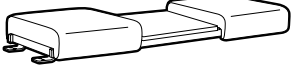
| DESCRIPTION | MODEL# | STANDARD FABRIC GRADES | | | | | | | | | | | |
|---|----------|--|--------|--------|------------------------|--------|--------|------------------------|--------|--------|--------|--------|--------|
| | | COM | 2 | 3 | 4 | 5 | 6 | 7 | 8 | 9 | 10 | 11 | 12 |
|  Bariatric High Back Armless Bridge Left & Right COM Yardage: 3.25 Freight Class: 300 Product Weight (lbs.): 50 Cubic Feet Per Carton: 26.50 | GC4269HB | \$1200 | \$1275 | \$1337 | \$1428 | \$1558 | \$1607 | \$1720 | \$1932 | \$2038 | \$2237 | \$2512 | \$2850 |
| | | OVERALL DIMENSIONS | | | SEAT DIMENSIONS | | | BACK DIMENSIONS | | | | | |
| | | W | D | H | W | D | H | W | H | | | | |
| | | | 37.5 | 24 | 30.5 | 32.5 | 18 | -- | 32.5 | 24.5 | | | |
| | | Not freestanding. Suspends between 2 units via linking brackets. • For users up to 750 lbs. | | | | | | | | | | | |
|  Single Seat Bench Bridge Left & Right COM Yardage: 1.50 Freight Class: 100 Product Weight (lbs.): 24 Cubic Feet Per Carton: 2.90 | GC4271 | \$710 | \$745 | \$773 | \$816 | \$875 | \$897 | \$949 | \$1048 | \$1097 | \$1189 | \$1315 | \$1472 |
| | | OVERALL DIMENSIONS | | | SEAT DIMENSIONS | | | BACK DIMENSIONS | | | | | |
| | | W | D | H | W | D | H | W | H | | | | |
| | | | 24.75 | 26.5 | 6 | | | | | | | | |
| | | Not freestanding. Suspends between 2 units via linking brackets. | | | | | | | | | | | |
|  Two Seat Bench Bridge Left & Right COM Yardage: 2.25 Freight Class: 125 Product Weight (lbs.): 64 Cubic Feet Per Carton: 9.25 | GC4272 | \$1296 | \$1349 | \$1391 | \$1454 | \$1544 | \$1577 | \$1656 | \$1803 | \$1877 | \$2014 | \$2204 | \$2440 |
| | | OVERALL DIMENSIONS | | | SEAT DIMENSIONS | | | BACK DIMENSIONS | | | | | |
| | | W | D | H | W | D | H | W | H | | | | |
| | | | 49.75 | 26.5 | 6 | | | | | | | | |
| | | Not freestanding. Suspends between 2 units via linking brackets. | | | | | | | | | | | |
|  Three Seat Bench Bridge Left & Right COM Yardage: 3 Freight Class: 125 Product Weight (lbs.): 68 Cubic Feet Per Carton: 9.25 | GC4273 | \$1923 | \$1993 | \$2050 | \$2134 | \$2254 | \$2298 | \$2403 | \$2599 | \$2698 | \$2881 | \$3134 | \$3447 |
| | | OVERALL DIMENSIONS | | | SEAT DIMENSIONS | | | BACK DIMENSIONS | | | | | |
| | | W | D | H | W | D | H | W | H | | | | |
| | | | 72.75 | 26.5 | 6 | | | | | | | | |
| | | Not freestanding. Suspends between 2 units via linking brackets. | | | | | | | | | | | |
|  Two Seat Bench Bridge Center Table Top, Left & Right COM Yardage: 2.25 Freight Class: 250 Product Weight (lbs.): 32 Cubic Feet Per Carton: 9.25 | GC4276 | \$1811 | \$1864 | \$1907 | \$1969 | \$2059 | \$2093 | \$2171 | \$2318 | \$2393 | \$2529 | \$2720 | \$2955 |
| | | OVERALL DIMENSIONS | | | SEAT DIMENSIONS | | | BACK DIMENSIONS | | | | | |
| | | W | D | H | W | D | H | W | H | | | | |
| | | | 72.75 | 26. | 6 | | | | | | | | |
| | | Not freestanding. Suspends between 2 units via linking brackets. • Table top only offered in High Pressure Laminate | | | | | | | | | | | |

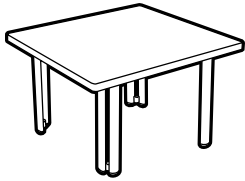
| TABLES | MODEL# | DIMENSIONS | FREIGHT CLASS | WT/LBS. | CUBIC FT. | LIST PRICE |
|---|-----------|--------------|---------------|---------|-----------|--------------|
|  | GC4281-LP | 18 x 22 x 16 | 100 | 30 | 3.40 | \$621 |
| | GC4281-HP | 18 x 22 x 16 | 100 | 30 | 3.40 | \$701 |

Rectangular End Table

- For a thermally fused laminate top (LP), specify model GC4281-LP.
- For a high pressure laminate top (HP), specify model GC4281-HP.

1" thick top with coordinating 3mm edge. Oval steel tube legs

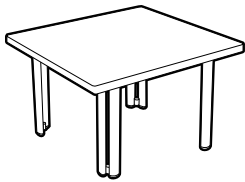

Square End Table

| | | | | | |
|-----------|--------------|-----|----|------|--------------|
| GC4288-LP | 23 x 23 x 16 | 100 | 31 | 3.40 | \$709 |
| GC4288-HP | 23 x 23 x 16 | 100 | 31 | 3.40 | \$787 |

- For a thermally fused laminate top (LP), specify model GC4288-LP.
- For a high pressure laminate top (HP), specify model GC4288-HP.

1" thick top with coordinating 3mm edge. Oval steel tube legs.



Square End Table

| | | | | | |
|-----------|--------------|-----|----|---|--------------|
| GC4282-LP | 30 x 30 x 16 | 150 | 34 | 6 | \$796 |
| GC4282-HP | 30 x 30 x 16 | 150 | 34 | 6 | \$888 |

- For a thermally fused laminate top (LP), specify model GC4282-LP.
- For a high pressure laminate top (HP), specify model GC4282-HP.

1" thick top with coordinating 3mm edge. Oval steel tube legs.

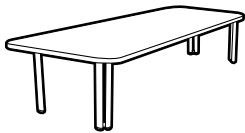

Rectangular Coffee Table

| | | | | | |
|-----------|--------------|-----|----|---|--------------|
| GC4283-LP | 22 x 54 x 16 | 125 | 37 | 6 | \$801 |
| GC4283-HP | 22 x 54 x 16 | 125 | 37 | 6 | \$934 |

- For a thermally fused laminate top (LP), specify model GC4283-LP.
- For a high pressure laminate top (HP), specify model GC4283-HP.

1" thick top with coordinating 3mm edge. Oval steel tube legs



Square Coffee Table

| | | | | | |
|-----------|--------------|-----|----|---|--------------|
| GC4284-LP | 36 x 36 x 16 | 125 | 37 | 6 | \$836 |
| GC4284-HP | 36 x 36 x 16 | 125 | 37 | 6 | \$934 |

- For a thermally fused laminate top (LP), specify model GC4284-LP.
- For a high pressure laminate top (HP), specify model GC4284-HP.

1" thick top with coordinating 3mm edge. Oval steel tube legs

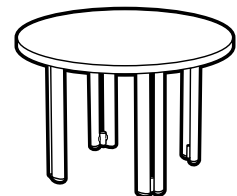

Round Coffee Table - 24" Diameter

| | | | | | |
|-----------|--------------|-----|----|------|--------------|
| GC4285-LP | 24 x 24 x 16 | 100 | 33 | 3.40 | \$779 |
| GC4285-HP | 24 x 24 x 16 | 100 | 33 | 3.40 | \$842 |

- For a thermally fused laminate top (LP), specify model GC4285-LP.
- For a high pressure laminate top (HP), specify model GC4285-HP.

1" thick top with coordinating 3mm edge. Oval steel tube legs

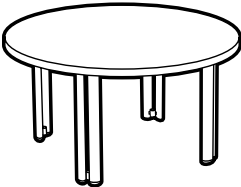
| TABLES | MODEL# | DIMENSIONS | FREIGHT CLASS | WT/LBS. | CUBIC FT. | LIST PRICE |
|---|-----------|--------------|---------------|---------|-----------|--------------|
|  | GC4286-LP | 30 x 30 x 16 | 150 | 34 | 6 | \$783 |
| | GC4286-HP | 30 x 30 x 16 | 150 | 34 | 6 | \$842 |

Round Coffee Table - 30" Diameter

- For a thermally fused laminate top (LP), specify model GC4286-LP.
- For a high pressure laminate top (HP), specify model GC4286-HP.

1" thick top with coordinating 3mm edge. Oval steel tube legs

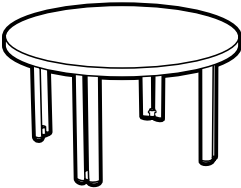
| | | | | | | |
|---|-----------|--------------|-----|----|---|--------------|
|  | GC4287-LP | 36 x 36 x 16 | 125 | 37 | 6 | \$884 |
| | GC4287-HP | 36 x 36 x 16 | 125 | 37 | 6 | \$983 |

Round Coffee Table - 36" Diameter

- For a thermally fused laminate top (LP), specify model GC4287-LP.
- For a high pressure laminate top (HP), specify model GC4287-HP.

1" thick top with coordinating 3mm edge. Oval steel tube legs

| TABLE BRIDGES | MODEL# | DIMENSIONS | FREIGHT CLASS | WT/LBS. | CUBIC FT. | LIST PRICE |
|---------------|--------|------------|---------------|---------|-----------|------------|
|---------------|--------|------------|---------------|---------|-----------|------------|

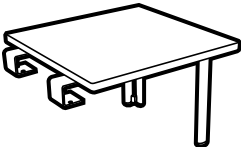
| | | | | | | |
|---|-----------|--------------|-----|----|------|--------------|
|  | GC4274-LP | 23 x 23 x 16 | 125 | 25 | 3.40 | \$510 |
| | GC4274-HP | 23 x 23 x 16 | 125 | 25 | 3.40 | \$546 |

End Table Bridge, Not Freestanding

- For a thermally fused laminate top (LP), specify model GC4274-LP.
- For a high pressure laminate top (HP), specify model GC4274-HP.

1 end suspends to a seating unit via linking brackets. 1" thick top with coordinating 3mm edge. Oval steel tube legs Reversible.

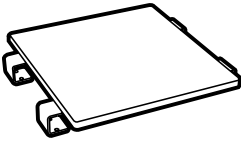
| | | | | | | |
|---|-----------|-------------|-----|----|------|--------------|
|  | GC4275-LP | 23 x 23 x 1 | 150 | 18 | 3.40 | \$355 |
| | GC4275-HP | 23 x 23 x 1 | 150 | 18 | 3.40 | \$401 |

Square Table Top, Not Freestanding

- For a thermally fused laminate top (LP), specify model GC4275-LP.
- For a high pressure laminate top (HP), specify model GC4275-HP.

Suspends between two seating units via linking brackets. 1" thick top with coordinating 3mm edge No legs. Reversible.

| | | | | | | |
|---|-----------|--------------|-----|----|---|--------------|
|  | GC4277-LP | 35 x 35 x 16 | 125 | 45 | 6 | \$567 |
| | GC4277-HP | 35 x 35 x 16 | 125 | 45 | 6 | \$650 |

End Corner Table Bridge Not Freestanding

- For a thermally fused laminate top (LP), specify model GC4277-LP.
- For a high pressure laminate top (HP), specify model GC4277-HP.

Suspends between two seating units via linking brackets. 1" thick top with coordinating 3mm edge. Oval steel tube legs Can be used for right or left corner.

| | | | | | | |
|---|-----------|--------------|-----|----|---|--------------|
|  | GC4278-LP | 35 x 35 x 16 | 125 | 45 | 6 | \$567 |
| | GC4278-HP | 35 x 35 x 16 | 125 | 45 | 6 | \$650 |

End Corner Curve Table Bridge Not Freestanding

- For a thermally fused laminate top (LP), specify model GC4278-LP.
- For a high pressure laminate top (HP), specify model GC4278-HP.

Suspends between two seating units via linking brackets. 1" thick top with coordinating 3mm edge. Oval steel tube legs Can be used for right or left corner.

GC-COMET



model GC2180 (TUN)



Black Plastic Arms



Wallsaver Leg

FEATURES

- The rounded steel frame and durable seat cushion will ensure years of use.
- Reinforced steel seat frame accommodates users up to 500 pounds.
- Black plastic arms are standard. Platinum (PLT) and Toast (TOA) are also available - Add \$27.00 list upcharge.
- The steel frame is available in Black (BLK), Platinum (PLT), Toast (TOA), Tungsten (TUN), Cappuccino (T20), Mocha (J52), and Kalua (KAL).
- Optional steel cushioned glides (B) are available - Add \$18.00 list upcharge.
- For Globalcare textiles and finish options, visit the web site at www.thinkglobalcare.com.
- This product can be upholstered in standard Global textiles only if Healthcare compliance is not required.
- This product is shipped fully assembled
- High density Ultracell Bio foam. Moisture Barrier (Seat Only) - Add \$127.00 list upcharge.
- For addition of a Fire Barrier Lining - Add \$65.00 list upcharge per yard.
- Call Customer Service for CAL133 approved textiles.

- This Bariatric model has been specially designed in consultation with Healthcare specialists to meet the needs of larger individuals.

SUGGESTED APPLICATIONS

- Patient Rooms
- Waiting Areas
- Exam Rooms
- Guest Seating
- Dining Rooms

| DESCRIPTION | MODEL# | STANDARD FABRIC GRADES | | | | | | | | | | | | | | | | | | | | | |
|--|--------|---|-------|-------|-------|-------|--------|--------|--------|--------|--|--------|--------|---|---|---|------|------|----|---|--|---|---|
| | | COM | 2 | 3 | 4 | 5 | 6 | 7 | 8 | 9 | 10 | 11 | 12 | | | | | | | | | | |
|  <p>Bariatric Lounge Chair COM Yardage: 1.75 Freight Class: 300 Product Weight (lbs.): 44 Cubic Feet Per Carton: 23</p> | GC2180 | \$794 | \$834 | \$867 | \$916 | \$986 | \$1012 | \$1073 | \$1188 | \$1245 | \$1352 | \$1500 | \$1682 | | | | | | | | | | |
| | | <p>OVERALL DIMENSIONS</p> <table border="1"> <thead> <tr> <th>W</th> <th>D</th> <th>H</th> </tr> </thead> <tbody> <tr> <td>31.5</td> <td>27</td> <td>38</td> </tr> </tbody> </table> | | | W | D | H | 31.5 | 27 | 38 | <p>SEAT DIMENSIONS</p> <table border="1"> <thead> <tr> <th>W</th> <th>D</th> <th>H</th> </tr> </thead> <tbody> <tr> <td>26.5</td> <td>18.5</td> <td>18</td> </tr> </tbody> </table> | | | W | D | H | 26.5 | 18.5 | 18 | <p>BACK DIMENSIONS</p> <table border="1"> <thead> <tr> <th>W</th> <th>H</th> </tr> </thead> <tbody> <tr> <td>26.5</td> <td>20</td> </tr> </tbody> </table> | | W | H |
| W | D | H | | | | | | | | | | | | | | | | | | | | | |
| 31.5 | 27 | 38 | | | | | | | | | | | | | | | | | | | | | |
| W | D | H | | | | | | | | | | | | | | | | | | | | | |
| 26.5 | 18.5 | 18 | | | | | | | | | | | | | | | | | | | | | |
| W | H | | | | | | | | | | | | | | | | | | | | | | |
| 26.5 | 20 | | | | | | | | | | | | | | | | | | | | | | |
| | | <p>• For users up to 500 lbs.</p> | | | | | | | | | | | | | | | | | | | | | |

GC-WIND



Removable Seat Cushion



Tubular Steel Leg

model 3361HB



model 3363HB

FEATURES

- A modern version of the traditional lounge chair that is scaled down for smaller spaces.
- Seat cushions are easily removable for cleaning and the open frame is great for housekeeping access.
- Ultracell foam seat for added comfort.
- Base is available in Chrome, Black (BLK), Charcoal (CHR), Platinum (PLT), Toast (TOA), Tungsten (TUN), Cappuccino (T20), Mocha (J52), and Kalua (KAL) are also available.
- Standard glide is plastic.
- For Globalcare textiles and finish options, visit the web site at www.thinkglobalcare.com.
- This product can be upholstered in standard Global textiles only if Healthcare compliance is not required.
- This product is shipped fully assembled
- Moisture Barrier (Seat Only) - Add \$127.00 list upcharge for Lounge Chair. For 2 seat sofa - Add \$254.00 list upcharge and for 3 seat sofa - Add \$380.00.
- For addition of a Fire Barrier Lining - Add \$65.00 list upcharge per yard.
- Call Customer Care for CAL133 approved textiles.

SUGGESTED APPLICATIONS

- Lounges
- Waiting Areas
- Lobbies

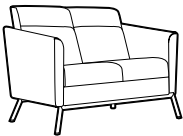
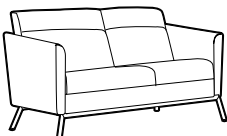
| DESCRIPTION | MODEL# | STANDARD FABRIC GRADES | | | | | | | | | | | |
|---|----------|------------------------|--------|--------|-----------------|--------|--------|-----------------|--------|--------|--------|--------|--------|
| | | COM | 2 | 3 | 4 | 5 | 6 | 7 | 8 | 9 | 10 | 11 | 12 |
|  High Back Lounge Chair COM Yardage: 4.75 Freight Class: 250 Product Weight (lbs.): 69 Cubic Feet Per Carton: 23 Loose seat cushion. | GC3361HB | \$1725 | \$1830 | \$2012 | \$2144 | \$2333 | \$2404 | \$2568 | \$2878 | \$3034 | \$3324 | \$3723 | \$4218 |
| | | OVERALL DIMENSIONS | | | SEAT DIMENSIONS | | | BACK DIMENSIONS | | | | | |
| | | W | D | H | W | D | H | W | H | | | | |
| | | | 27.5 | 29 | 36 | 19.5 | 19 | 17 | 19 | 19.5 | | | |
|  High Back Two Seat Sofa COM Yardage: 8 Freight Class: 250 Product Weight (lbs.): 107 Cubic Feet Per Carton: 42.75 Loose seat cushions. | GC3362HB | \$2049 | \$2226 | \$2488 | \$2712 | \$3028 | \$3150 | \$3427 | \$3950 | \$4211 | \$4696 | \$5372 | \$6205 |
| | | OVERALL DIMENSIONS | | | SEAT DIMENSIONS | | | BACK DIMENSIONS | | | | | |
| | | W | D | H | W | D | H | W | H | | | | |
| | | | 54.5 | 29 | 36 | 46.5 | 19 | 17 | 46.5 | 19.5 | | | |
|  High Back Three Seat Sofa COM Yardage: 12.25 Freight Class: 250 Product Weight (lbs.): 140 Cubic Feet Per Carton: 59.75 Loose seat cushions. | GC3363HB | \$2551 | \$2823 | \$3195 | \$3538 | \$4024 | \$4207 | \$4631 | \$5432 | \$5834 | \$6577 | \$7610 | \$8886 |
| | | OVERALL DIMENSIONS | | | SEAT DIMENSIONS | | | BACK DIMENSIONS | | | | | |
| | | W | D | H | W | D | H | W | H | | | | |
| | | | 78 | 29 | 36 | 70.5 | 19 | 17 | 70.5 | 19.5 | | | |

HEATHER



model GC3770



STANDARD FEATURES

- Contemporary slim line design is compact and stylish for a variety of different environments.
- Seat cushions are easily removable for cleaning.
- Wood legs are available in a variety of finishes. **Available in Maple wood Only.**
- Matching tapered leg tables are also available, see table section pages 18-41.
- For Globalcare textiles and wood finish options, visit the web site at www.thinkglobalcare.com.
- This product can be upholstered in standard Global textiles only if Healthcare compliance is not required.
- This product is shipped fully assembled.

- Standard glide is plastic. For Non-slip glides specify (NS) - **Add \$21.00** list upcharge.
- Seat is made from Ultracell foam for added comfort. Moisture Barrier (Seat Only) - **Add \$85.00** list upcharge.
- For addition of a Fire Barrier Lining - **Add \$65.00** list upcharge per yard.
- Call Customer Service for **CAL133** approved textiles.

SUGGESTED APPLICATIONS

- Waiting Areas
- Guest Seating
- Lounges
- Lobbies
- Resident Rooms

| DESCRIPTION | MODEL# | STANDARD FABRIC GRADES | | | | | | | | | | | |
|---|--------|---|--------|--------|--|--------|--------|--|--------|--------|--------|--------|--------|
| | | COM | 2 | 3 | 4 | 5 | 6 | 7 | 8 | 9 | 10 | 11 | 12 |
|  <p>High Back Lounge Chair COM Yardage: 3.25 Freight Class: 250 Product Weight (lbs.): 40 Cubic Feet Per Carton: 17</p> | GC3770 | \$1024 | \$1091 | \$1206 | \$1295 | \$1423 | \$1470 | \$1581 | \$1790 | \$1894 | \$2088 | \$2357 | \$2689 |
| | | <p>OVERALL DIMENSIONS</p> <p>W D H</p> <p>24 24.5 36.5</p> | | | <p>SEAT DIMENSIONS</p> <p>W D H</p> <p>18.5 17 18</p> | | | <p>BACK DIMENSIONS</p> <p>W H</p> <p>19.5 18.5</p> | | | | | |
|  <p>Low Back Lounge Chair COM Yardage: 3 Freight Class: 250 Product Weight (lbs.): 36 Cubic Feet Per Carton: 13.25</p> | GC3771 | \$1014 | \$1074 | \$1184 | \$1267 | \$1383 | \$1427 | \$1530 | \$1723 | \$1819 | \$1996 | \$2247 | \$2552 |
| | | <p>OVERALL DIMENSIONS</p> <p>W D H</p> <p>24 24.5 31.5</p> | | | <p>SEAT DIMENSIONS</p> <p>W D H</p> <p>18.5 17 18</p> | | | <p>BACK DIMENSIONS</p> <p>W H</p> <p>19.5 13.25</p> | | | | | |



Interlock is the ideal modular linking system for any hospital or long term care facility. Create a simple or complex configuration that is sure to fit small or large rooms and reception areas.

The variety of components include seating and benches in single, two or three seater styles and occasional tables in round, square and rectangular shapes.

Seating units are designed with or without arms and can stand alone or connect to other seating units, tables or benches. Two and three seat models are available with half arms designed to divide the seats.

Bench styles include all seats or seats with a convenient square tablet.



Low Back, High Back and Bariatric chair options. Removable seat and back covers for easy cleaning



Bench styles can be used as a stand alone bench or connect to seating, bench or table options



Occasional Tables are available in round, square and rectangular shapes. All table tops are available in high pressure laminate

Features and Benefits

- Ultracell foam on all seat cushions
- **Perma-Mesh™** suspension with one piece, 2" steel double interior frame
- A variety of healthcare compliant fabrics and vinyls designed to protect against bacteria
- Freestanding seating solutions with Stand Alone Single, Double, Triple and Bariatric frame structures
- Completely modular build-up solutions for any number of possible applications
- All aluminum arm/leg frames are standard in Tungsten finish, Black PVC front leg cap(s) and Black, self-skinned urethane armcaps.
- Options include Armcaps in Wood or Leg Caps in Wood or Aluminum
- Choose from a variety of warm Wood finishes or Aluminum selections in Silver, Champagne or Bronze
- Full leg caps are available on seating styles only
- Square, 45° or 90° tables allow for the reation of simple or complex configurations
- Square and rectangular tables are also available with a lower magazine rack.

PACKAGE 1

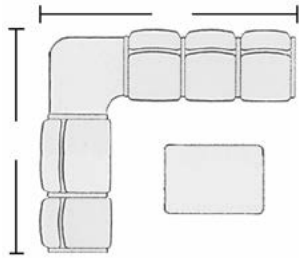

| Description |
|---|
| Medium Back Single Seat Chair (aluminum single arm/leg frame - right) |
| Medium Back Single Seat Armchair (aluminum arm/leg frame, bariatric) |
| 90° Corner Table - Radius (aluminum leg) |
| Medium Back Three Seat Chair (aluminum arm/leg frame, half center arms) |

| Qty | Model Number | Dimensions | Ydg. | Freight Class | Wt./Lbs. | Cu. Ft. | List Price |
|-----|--------------|--------------|------|---------------|----------|---------|------------|
| 1 | GC4106R | 25 x 23 x 37 | 1.75 | 250 | 45 | 17 | \$983 |
| 1 | GC4125 | 25 x 35 x 37 | 3.75 | 250 | 74 | 26.50 | \$1624 |
| 1 | GC4100RC | 35 x 35 x 16 | -- | 125 | 45 | 6 | \$746 |
| 1 | GC4115 | 25 x 71 x 37 | 5.50 | 250 | 141 | 65.25 | \$3190 |
| 1 | GC4109R | 25 x 48 x 16 | -- | 125 | 39 | 5.75 | \$831 |

**Standard Armcap (Black Urethane)
Standard Leg Cap (Black Urethane)**

PACKAGE TOTAL \$7374
(*Please Note: List Prices shown are for the standard Grade 4 vinyl/standard finishes.)

PACKAGE 2

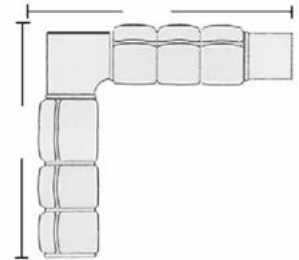

| Description |
|--|
| Medium Back Single Seat Armchair (aluminum arm/leg frame), w/optional Aluminum Leg Caps |
| Medium Back Single Seat Armless Top (standard) |
| Medium Back Single Seat Armchair (aluminum arm/leg frame, bariatric), w/optional Aluminum Leg Caps |
| 90° Corner Table - Square (aluminum leg), w/optional Aluminum Leg Cap |
| Medium Back Three Seat Chair (aluminum arm/leg frame, no center arm), w/optional Aluminum Leg Caps |
| End Run Table (aluminum legs), w/optional Aluminum Leg Caps |

| Qty | Model Number | Dimensions | Ydg. | Freight Class | Wt./Lbs. | Cu. Ft. | List Price |
|-----|--------------|------------------|------|---------------|----------|---------|------------|
| 1 | GC4105 | 25 x 25.25 x 37 | 1.75 | 250 | 54 | 17 | \$1232 |
| | | | | | | | \$217 |
| 1 | GC4105TOP | 23 x 21.5 x 20.5 | 1.75 | 150 | 36 | 7.50 | \$787 |
| 1 | GC4125 | 25 x 35 x 37 | 3.75 | 250 | 74 | 26.50 | \$1624 |
| | | | | | | | \$220 |
| 1 | GC4100SC | 35 x 35 x 16 | -- | 125 | 45 | 6 | \$746 |
| | | | | | | | \$51 |
| 1 | GC4119 | 25 x 68 x 37 | 5.50 | 250 | 135 | 65.25 | \$2595 |
| | | | | | | | \$217 |
| 1 | GC4100SE | 23 x 23 x 16 | -- | 150 | 17 | 3.40 | \$588 |
| | | | | | | | \$97 |

PACKAGE TOTAL \$8374
(*Please Note: List Prices shown are for the standard Grade 4 vinyl/standard finishes.)

PACKAGE 3

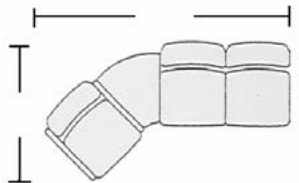

| Description |
|---|
| Medium Back Single Seat Armchair (aluminum arm/leg frame), w/optional Wood Armcaps w/optional Wood Leg Caps |
| 45° Table Top |
| Medium Back Two Seat Chair (aluminum leg frame, armless), w/standard Black Armcaps w/optional Wood Leg Caps |

| Qty | Model Number | Dimensions | Ydg. | Freight Class | Wt./Lbs. | Cu. Ft. | List Price |
|-----|--------------|-----------------|------|---------------|----------|---------|------------|
| 1 | GC4105 | 25 x 25.25 x 37 | 1.75 | 250 | 54 | 17 | \$1232 |
| | | | | | | | \$97 |
| | | | | | | | \$120 |
| 1 | GC4134AT | 23 x 24 x 1 | -- | 250 | 12 | 3.40 | \$399 |
| 1 | GC4118NA | 25 x 45.5 x 37 | 3.75 | 300 | 86 | 45.75 | \$1668 |
| | | | | | | | \$120 |

**Standard Armcap (Black Urethane)
Optional Leg Cap (Aluminum)**

PACKAGE TOTAL \$3636
(* Please Note: List Prices shown are for the standard Grade 4 vinyl/standard laminate.)

INTERLOCK



model GC4101

model GC4114

FEATURES

- Single, two or three seater styles with or without arms ensure that the perfect configuration is possible no matter the size or shape of the space.
- Seat and back textile may vary if desired. Please contact your GlobalCare sales representative for further details.
- Not available in Leather or Leather/Mock Leather combination.
- High back and medium back cushions are interchangeable and can be placed as desired, at time of installation.
- Single frame units used as a modular solution will allow for re-configuration of product if required.
- Bariatric chair(s) can be used in a single or linked application. Full height arm frames must be used at all times for safety and to assist a user when entering or exiting the chair. Bariatric seating is rated for use by persons up to 750 lbs.
- Maximum Seat Run - For specifications using single seat frames connected without center support legs, the maximum run is three and must include the upper arm unit (models GC4112HA/WHA) between each single frame. (See complete unit GC4115W for example.) The application can be repeated when a full height frame is used to link every 3rd position.
- Tablet Tops (for use in linked applications) are 1" thick and available in the following high pressure laminates with matching 3mm PVC edge; Avant Cherry (W357), Avant Honey (W356), Brushed Cobalt (BCH), Clear Maple (CMB), Constellation Java (CJH), Dark Espresso (W142), Empire Mahogany (EMB), Quartered Mahogany (W313), Shaker Cherry (SKB), Tiger Fruitwood (W821), Tiger Maple (W820), and Tiger Walnut (W819).

- High density Ultracell foam is standard. Moisture Barrier (Seat Only) - **Add \$85.00** list upcharge per seat. For GC4125, GC4125W, GC4125F, GC4125L, GC4125HB, GC4125WHB, GC4125FHB and GC4125LHB Bariatric models - **Add \$131.00** list upcharge per seat.
- Call Customer Service for **CAL133** approved textiles.
- For addition of a Fire Barrier Lining - **Add \$65.00** list upcharge per yard.
- The seat and back are removable and field replaceable.
- Left and Right Position Reference is determined based on being seated in the chair.
- Order Placement - For layouts that require any linking units, a layout must be provided at the time of order placement. If no drawing is included the order can not be processed.
- Specification and Layout Assistance - Contact your GlobalCare Sales representative for assistance.
- Orders must be accompanied with a layout if multiple units are being connected.
- Shipping Information - Pricing provided is based on the standard shipping method. Standard shipping for Stand Alone Units is Semi-Knock Down (SK) (backs off). Standard shipping for Modular Units is Knock Down (KD). For Fully Assembled, please contact your GlobalCare Sales Representative for a special quotation.

SUGGESTED APPLICATIONS

- Waiting Areas
- Patient Rooms
- Lobbies
- Exam Rooms

ALUMINUM ARM AND LEG FRAME INSERT OPTIONS

- Aluminum arm/leg frames are available in Platinum (PLT), Toast (TOA), Tungsten (TUN), Cappuccino (T20), Mocha (J52) and Kalua (KAL). Please Specify.
- **Armcaps:**
SSU - Available in Black (BLK), Platinum (PLT), Toast (TOA), Cappuccino (T20), Mocha (J52) and Kalua (KAL). Please Specify.
Wood - Available in the following finishes; Absolute (AAM), Brandy Peppercorn (BPM), Charcoal Java (CJM), Cherry (ACM), Cherry Latte (CLM), Cocoa Vanilla (CVM), Empire Mahogany (EMM), English Oak (EOM), Espresso Cafe (ECM), Fruitwood (TFM), Gray (HGM), Harvest Oak (HOM), Honey (AHM), Jet Onyx (JOM), Light Honey (LHM), Mahogany (TMM), Maple (AVM), Medium Walnut (MWM), Night (ASM), Sandy Beach (SBM), Shaker Cherry (SKM), Silver Oak (SOM), Walnut (TWM), White (WHM), WC Cream (WTM) and Winter Cherry (WCM).
See individual models for specific upcharge.
- **Leg Cap:** The Half-Leg option refers to the armless leg. The **Full Leg** option refers to the arm and leg combination (with standard black, urethane armcap).
Standard - Urethane Ribbed Leg Insert - Available in Black (BK) Only.
Aluminum Ribbed Leg Inserts are available in - Silver (AU), Champagne (CP) and Bronze (LB).
Non-Ribbed Leg Inserts are available in - Silver (PS), Platinum (PLT), Toast (TOA), Cappuccino (T20), Mocha (J52) and Kalua (KAL).
See individual models for specific upcharge. MUST Specify Ribbed or Non-Ribbed when ordering.
- Wood - Available in the following finishes; Absolute (AAM), Brandy Peppercorn (BPM), Charcoal Java (CJM), Cherry (ACM), Cherry Latte (CLM), Cocoa Vanilla (CVM), Empire Mahogany (EMM), English Oak (EOM), Espresso Cafe (ECM), Fruitwood (TFM), Gray (HGM), Harvest Oak (HOM), Honey (AHM), Jet Onyx (JOM), Light Honey (LHM), Mahogany (TMM), Maple (AVM), Medium Walnut (MWM), Night (ASM), Sandy Beach (SBM), Shaker Cherry (SKM), Silver Oak (SOM), Walnut (TWM), White (WHM), WC Cream (WTM) and Winter Cherry (WCM).
See individual models for specific upcharge.
- Maple faced veneers and solids are used for all finishes.

STANDARD



Armcap - Self-Skinned Urethane
Leg Cap - Black (Ribbed), PVC front leg cap

OPTION



Armcap - Self-Skinned Urethane
Leg Cap - Aluminum (Ribbed or non-Ribbed - Silver only) front leg cap

OPTION

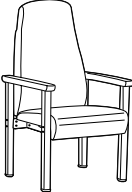

Armcap - Wood
Leg Cap - Wood, front leg cap

| DESCRIPTION | MODEL# | STANDARD FABRIC GRADES | | | | | | | | | | | |
|---|--------|---------------------------|--------|--------|------------------------|--------|--------|------------------------|--------|--------|--------|--------|--------|
| | | COM | 2 | 3 | 4 | 5 | 6 | 7 | 8 | 9 | 10 | 11 | 12 |
|  | GC4101 | \$1251 | \$1291 | \$1389 | \$1438 | \$1508 | \$1545 | \$1611 | \$1706 | \$1794 | \$1872 | \$2065 | \$2065 |
| | | OVERALL DIMENSIONS | | | SEAT DIMENSIONS | | | BACK DIMENSIONS | | | | | |
| | | W | D | H | W | D | H | W | H | | | | |
| | | 25.25 | 25 | 46.5 | 21.5 | 18 | 18.5 | 19.5 | 28 | | | | |

High Back Single Seat Armchair
 COM Yardage: 2
 Freight Class: 250
 Product Weight (lbs.): 57
 Cubic Feet Per Carton: 20

Aluminum Arms/Leg Frame
 Armcap/Leg Cap Black Urethane: No Upcharge
 Armcap Option - Wood: **Add 97.00**
 Leg Cap Option - Wood: **Add 120.00**
 Leg Cap Option - Aluminum: **Add 217.00**

• For users up to 500 lbs.

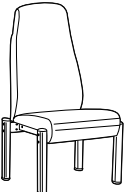
| DESCRIPTION | MODEL# | STANDARD FABRIC GRADES | | | | | | | | | | | |
|---|----------|---------------------------|--------|--------|------------------------|--------|--------|------------------------|--------|--------|--------|--------|--------|
| | | COM | 2 | 3 | 4 | 5 | 6 | 7 | 8 | 9 | 10 | 11 | 12 |
|  | GC4101NA | \$1039 | \$1078 | \$1167 | \$1215 | \$1285 | \$1322 | \$1388 | \$1481 | \$1570 | \$1646 | \$1842 | \$1842 |
| | | OVERALL DIMENSIONS | | | SEAT DIMENSIONS | | | BACK DIMENSIONS | | | | | |
| | | W | D | H | W | D | H | W | H | | | | |
| | | 25.25 | 25 | 46.5 | 21.5 | 18 | 18.5 | 19.5 | 28 | | | | |

High Back Single Seat Armchair
 COM Yardage: 2
 Freight Class: 250
 Product Weight (lbs.): 44
 Cubic Feet Per Carton: 20

Aluminum Leg Frame
 Leg Cap Black Urethane: No Upcharge
 Leg Cap Option - Wood: **Add 120.00**
 Leg Cap Option - Aluminum: **Add 189.00**

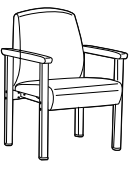
| DESCRIPTION | MODEL# | STANDARD FABRIC GRADES | | | | | | | | | | | |
|--|--------|---------------------------|--------|--------|------------------------|--------|--------|------------------------|--------|--------|--------|--------|--------|
| | | COM | 2 | 3 | 4 | 5 | 6 | 7 | 8 | 9 | 10 | 11 | 12 |
|  | GC4105 | \$1198 | \$1232 | \$1323 | \$1367 | \$1426 | \$1460 | \$1517 | \$1599 | \$1677 | \$1744 | \$1915 | \$1915 |
| | | OVERALL DIMENSIONS | | | SEAT DIMENSIONS | | | BACK DIMENSIONS | | | | | |
| | | W | D | H | W | D | H | W | H | | | | |
| | | 25.25 | 25 | 37 | 21.5 | 18 | 18.5 | 19.5 | 18.5 | | | | |

Medium Back Single Seat Armchair
 COM Yardage: 1.75
 Freight Class: 250
 Product Weight (lbs.): 54
 Cubic Feet Per Carton: 17

Aluminum Arms/Leg Frame
 Armcap/Leg Cap Black Urethane: No Upcharge
 Armcap Option - Wood: **Add 97.00**
 Leg Cap Option - Wood: **Add 120.00**
 Leg Cap Option - Aluminum: **Add 217.00**

• For users up to 500 lbs.

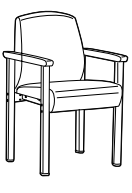
| DESCRIPTION | MODEL# | STANDARD FABRIC GRADES | | | | | | | | | | | |
|---|-----------|---------------------------|--------|--------|------------------------|--------|--------|------------------------|--------|--------|--------|--------|--------|
| | | COM | 2 | 3 | 4 | 5 | 6 | 7 | 8 | 9 | 10 | 11 | 12 |
|  | GC4105-24 | \$1522 | \$1560 | \$1672 | \$1722 | \$1791 | \$1818 | \$1878 | \$1992 | \$2051 | \$2157 | \$2305 | \$2305 |
| | | OVERALL DIMENSIONS | | | SEAT DIMENSIONS | | | BACK DIMENSIONS | | | | | |
| | | W | D | H | W | D | H | W | H | | | | |
| | | 25.25 | 25 | 46.5 | 21.5 | 18 | 18.5 | 19.5 | 28 | | | | |

Medium Back Single Seat Armchair
 COM Yardage: 1.75
 Freight Class: 250
 Product Weight (lbs.): 56
 Cubic Feet Per Carton: 20

Aluminum Arms/Leg Frame, Post Surgery Height
 Armcap/Leg Cap Black Urethane: No Upcharge
 Armcap Option - Wood: **Add 97.00**
 Leg Cap Option - Wood: **Add 160.00**
 Leg Cap Option - Aluminum: **Add 217.00**

• For users up to 500 lbs.

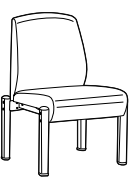
| DESCRIPTION | MODEL# | STANDARD FABRIC GRADES | | | | | | | | | | | |
|---|----------|---------------------------|--------|--------|------------------------|--------|--------|------------------------|--------|--------|--------|--------|--------|
| | | COM | 2 | 3 | 4 | 5 | 6 | 7 | 8 | 9 | 10 | 11 | 12 |
|  | GC4105NA | \$985 | \$1018 | \$1100 | \$1144 | \$1204 | \$1236 | \$1293 | \$1377 | \$1453 | \$1522 | \$1689 | \$1689 |
| | | OVERALL DIMENSIONS | | | SEAT DIMENSIONS | | | BACK DIMENSIONS | | | | | |
| | | W | D | H | W | D | H | W | H | | | | |
| | | 25.25 | 25 | 37 | 21.5 | 18 | 18.5 | 19.5 | 18.5 | | | | |

Medium Back Single Seat Armchair
 COM Yardage: 1.75
 Freight Class: 250
 Product Weight (lbs.): 44
 Cubic Feet Per Carton: 17

Aluminum Leg Frame
 Leg Cap Black Urethane: No Upcharge
 Leg Cap Option - Wood: **Add 120.00**
 Leg Cap Option - Aluminum: **Add 189.00**

| DESCRIPTION | MODEL# | STANDARD FABRIC GRADES | | | | | | | | | | | |
|-------------|--------|------------------------|---|---|---|---|---|---|---|---|----|----|----|
| | | COM | 2 | 3 | 4 | 5 | 6 | 7 | 8 | 9 | 10 | 11 | 12 |

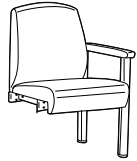

GC4106L

| | | | | | | | | | | | |
|-------|-------|--------|--------|--------|--------|--------|--------|--------|--------|--------|--------|
| \$949 | \$983 | \$1062 | \$1106 | \$1167 | \$1198 | \$1256 | \$1337 | \$1415 | \$1483 | \$1653 | \$1653 |
|-------|-------|--------|--------|--------|--------|--------|--------|--------|--------|--------|--------|

| OVERALL DIMENSIONS | | | SEAT DIMENSIONS | | | BACK DIMENSIONS | |
|--------------------|----|----|-----------------|----|------|-----------------|------|
| W | D | H | W | D | H | W | H |
| 25.25 | 25 | 37 | 21.5 | 18 | 18.5 | 19.5 | 18.5 |

Medium Back Single Seat Armchair
 COM Yardage: 1.75
 Freight Class: 250
 Product Weight (lbs.): 45
 Cubic Feet Per Carton: 17

Aluminum Single Arms/Leg Frame - Left
 Armcap/Leg Cap Black Urethane: No Upcharge
 Armcap Option - Wood: **Add 50.00**
 Leg Cap Option - Wood: **Add 61.00**
 Leg Cap Option - Aluminum: **Add 110.00**



GC4106HBL

| | | | | | | | | | | | |
|--------|--------|--------|--------|--------|--------|--------|--------|--------|--------|--------|--------|
| \$1004 | \$1042 | \$1129 | \$1178 | \$1248 | \$1285 | \$1351 | \$1446 | \$1534 | \$1611 | \$1805 | \$1805 |
|--------|--------|--------|--------|--------|--------|--------|--------|--------|--------|--------|--------|

| OVERALL DIMENSIONS | | | SEAT DIMENSIONS | | | BACK DIMENSIONS | |
|--------------------|----|----|-----------------|----|------|-----------------|------|
| W | D | H | W | D | H | W | H |
| 25.25 | 25 | 37 | 21.5 | 18 | 18.5 | 19.5 | 18.5 |

Medium Back Single Seat Armchair
 COM Yardage: 2
 Freight Class: 250
 Product Weight (lbs.): 48
 Cubic Feet Per Carton: 20

Aluminum Single Arms/Leg Frame - Left
 Armcap/Leg Cap Black Urethane: No Upcharge
 Armcap Option - Wood: **Add 50.00**
 Leg Cap Option - Wood: **Add 61.00**
 Leg Cap Option - Aluminum: **Add 110.00**

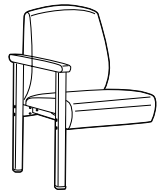

GC4106R

| | | | | | | | | | | | |
|-------|-------|--------|--------|--------|--------|--------|--------|--------|--------|--------|--------|
| \$949 | \$983 | \$1062 | \$1106 | \$1167 | \$1198 | \$1256 | \$1337 | \$1415 | \$1483 | \$1653 | \$1653 |
|-------|-------|--------|--------|--------|--------|--------|--------|--------|--------|--------|--------|

| OVERALL DIMENSIONS | | | SEAT DIMENSIONS | | | BACK DIMENSIONS | |
|--------------------|----|----|-----------------|----|------|-----------------|------|
| W | D | H | W | D | H | W | H |
| 23 | 25 | 37 | 21.5 | 18 | 18.5 | 19.5 | 18.5 |

Medium Back Single Seat Armchair
 COM Yardage: 1.75
 Freight Class: 250
 Product Weight (lbs.): 45
 Cubic Feet Per Carton: 17

Aluminum Single Arms/Leg Frame - Right
 Armcap/Leg Cap Black Urethane: No Upcharge
 Armcap Option - Wood: **Add 50.00**
 Leg Cap Option - Wood: **Add 61.00**
 Leg Cap Option - Aluminum: **Add 110.00**



GC4106HBR

| | | | | | | | | | | | |
|--------|--------|--------|--------|--------|--------|--------|--------|--------|--------|--------|--------|
| \$1004 | \$1042 | \$1129 | \$1178 | \$1248 | \$1285 | \$1351 | \$1446 | \$1534 | \$1611 | \$1805 | \$1805 |
|--------|--------|--------|--------|--------|--------|--------|--------|--------|--------|--------|--------|

| OVERALL DIMENSIONS | | | SEAT DIMENSIONS | | | BACK DIMENSIONS | |
|--------------------|----|------|-----------------|----|------|-----------------|----|
| W | D | H | W | D | H | W | H |
| 23 | 25 | 46.5 | 21.5 | 18 | 18.5 | 19.5 | 28 |

High Back Single Seat Armchair
 COM Yardage: 2
 Freight Class: 250
 Product Weight (lbs.): 48
 Cubic Feet Per Carton: 20

Aluminum Single Arms/Leg Frame - Right
 Armcap/Leg Cap Black Urethane: No Upcharge
 Armcap Option - Wood: **Add 50.00**
 Leg Cap Option - Wood: **Add 61.00**
 Leg Cap Option - Aluminum: **Add 110.00**

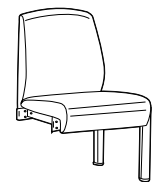

GC4106LNA

| | | | | | | | | | | | |
|-------|-------|-------|-------|--------|--------|--------|--------|--------|--------|--------|--------|
| \$844 | \$876 | \$951 | \$994 | \$1056 | \$1086 | \$1145 | \$1228 | \$1305 | \$1373 | \$1542 | \$1542 |
|-------|-------|-------|-------|--------|--------|--------|--------|--------|--------|--------|--------|

| OVERALL DIMENSIONS | | | SEAT DIMENSIONS | | | BACK DIMENSIONS | |
|--------------------|----|----|-----------------|----|------|-----------------|------|
| W | D | H | W | D | H | W | H |
| 23 | 25 | 37 | 21.5 | 18 | 18.5 | 19.5 | 18.5 |

Medium Back Single Seat Chair
 COM Yardage: 1.75
 Freight Class: 250
 Product Weight (lbs.): 42
 Cubic Feet Per Carton: 17

Aluminum Single Arms/Leg Frame - Left
 Leg Cap Black Urethane: No Upcharge
 Leg Cap Option - Wood: **Add 61.00**
 Leg Cap Option - Aluminum: **Add 97.00**

| DESCRIPTION | MODEL# | STANDARD FABRIC GRADES | | | | | | | | | | | |
|---|-------------|---------------------------|-------|--------|------------------------|--------|--------|------------------------|--------|--------|--------|--------|--------|
| | | COM | 2 | 3 | 4 | 5 | 6 | 7 | 8 | 9 | 10 | 11 | 12 |
|  | GC4106HBLNA | \$897 | \$936 | \$1017 | \$1065 | \$1135 | \$1173 | \$1238 | \$1334 | \$1421 | \$1499 | \$1692 | \$1692 |
| | | OVERALL DIMENSIONS | | | SEAT DIMENSIONS | | | BACK DIMENSIONS | | | | | |
| | | W | D | H | W | D | H | W | H | | | | |
| | | 23 | 25 | 46.5 | 21.5 | 18 | 18.5 | 19.5 | 28 | | | | |

High Back Single Seat Chair
 COM Yardage: 2
 Freight Class: 250
 Product Weight (lbs.): 48
 Cubic Feet Per Carton: 20

Aluminum Single Arms/Leg Frame - Left
 Leg Cap Black Urethane: No Upcharge
 Leg Cap Option - Wood: **Add 61.00**
 Leg Cap Option - Aluminum: **Add 97.00**

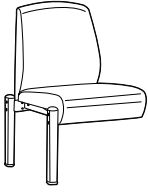
| DESCRIPTION | MODEL# | STANDARD FABRIC GRADES | | | | | | | | | | | |
|---|-----------|---------------------------|-------|-------|------------------------|--------|--------|------------------------|--------|--------|--------|--------|--------|
| | | COM | 2 | 3 | 4 | 5 | 6 | 7 | 8 | 9 | 10 | 11 | 12 |
|  | GC4106RNA | \$844 | \$876 | \$951 | \$994 | \$1056 | \$1086 | \$1145 | \$1228 | \$1305 | \$1373 | \$1542 | \$1542 |
| | | OVERALL DIMENSIONS | | | SEAT DIMENSIONS | | | BACK DIMENSIONS | | | | | |
| | | W | D | H | W | D | H | W | H | | | | |
| | | 23 | 25 | 37 | 21.5 | 18 | 18.5 | 19.5 | 18.5 | | | | |

Medium Back Single Seat Chair
 COM Yardage: 1.75
 Freight Class: 250
 Product Weight (lbs.): 42
 Cubic Feet Per Carton: 17

Aluminum Leg Frame - Right
 Leg Cap Black Urethane: No Upcharge
 Leg Cap Option - Wood: **Add 61.00**
 Leg Cap Option - Aluminum: **Add 97.00**

| DESCRIPTION | MODEL# | STANDARD FABRIC GRADES | | | | | | | | | | | |
|--|-------------|---------------------------|-------|--------|------------------------|--------|--------|------------------------|--------|--------|--------|--------|--------|
| | | COM | 2 | 3 | 4 | 5 | 6 | 7 | 8 | 9 | 10 | 11 | 12 |
|  | GC4106HBRNA | \$897 | \$936 | \$1017 | \$1065 | \$1135 | \$1173 | \$1238 | \$1334 | \$1421 | \$1499 | \$1692 | \$1692 |
| | | OVERALL DIMENSIONS | | | SEAT DIMENSIONS | | | BACK DIMENSIONS | | | | | |
| | | W | D | H | W | D | H | W | H | | | | |
| | | 23 | 25 | 46.5 | 21.5 | 18 | 18.5 | 19.5 | 28 | | | | |

High Back Single Seat Chair
 COM Yardage: 2
 Freight Class: 250
 Product Weight (lbs.): 48
 Cubic Feet Per Carton: 20

Aluminum Leg Frame - Right
 Leg Cap Black Urethane: No Upcharge
 Leg Cap Option - Wood: **Add 61.00**
 Leg Cap Option - Aluminum: **Add 97.00**

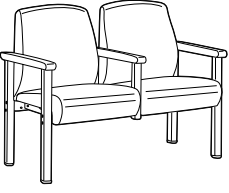
| DESCRIPTION | MODEL# | STANDARD FABRIC GRADES | | | | | | | | | | | |
|---|--------|---------------------------|--------|--------|------------------------|--------|--------|------------------------|--------|--------|--------|--------|--------|
| | | COM | 2 | 3 | 4 | 5 | 6 | 7 | 8 | 9 | 10 | 11 | 12 |
|  | GC4114 | \$2131 | \$2218 | \$2289 | \$2394 | \$2543 | \$2600 | \$2730 | \$2976 | \$3098 | \$3327 | \$3644 | \$3644 |
| | | OVERALL DIMENSIONS | | | SEAT DIMENSIONS | | | BACK DIMENSIONS | | | | | |
| | | W | D | H | W | D | H | W | H | | | | |
| | | 48.25 | 25 | 37 | 21.5 | 18 | 18.5 | 19.5 | 18.5 | | | | |

Medium Back Two Seat Chair Half Center Arm
 COM Yardage: 3.75
 Freight Class: 250
 Product Weight (lbs.): 102
 Cubic Feet Per Carton: 45.75

Aluminum Arms/Leg Frame
 Armcap/Leg Cap Black Urethane: No Upcharge
 Armcap Option - Wood: **Add 142.00**
 Leg Cap Option - Wood: **Add 179.00**
 Leg Cap Option - Aluminum: **Add 310.00**

| DESCRIPTION | MODEL# | STANDARD FABRIC GRADES | | | | | | | | | | | |
|---|----------|---------------------------|--------|--------|------------------------|--------|--------|------------------------|--------|--------|--------|--------|--------|
| | | COM | 2 | 3 | 4 | 5 | 6 | 7 | 8 | 9 | 10 | 11 | 12 |
|  | GC4114HB | \$2262 | \$2361 | \$2441 | \$2560 | \$2729 | \$2793 | \$2941 | \$3220 | \$3359 | \$3618 | \$3977 | \$3977 |
| | | OVERALL DIMENSIONS | | | SEAT DIMENSIONS | | | BACK DIMENSIONS | | | | | |
| | | W | D | H | W | D | H | W | H | | | | |
| | | 48.25 | 25 | 46.5 | 21.5 | 18 | 18.5 | 19.5 | 28 | | | | |

High Back Two Seat Chair Half Center Arm
 COM Yardage: 4.25
 Freight Class: 300
 Product Weight (lbs.): 110
 Cubic Feet Per Carton: 56.50

Aluminum Arms/Leg Frame
 Armcap/Leg Cap Black Urethane: No Upcharge
 Armcap Option - Wood: **Add 142.00**
 Leg Cap Option - Wood: **Add 179.00**
 Leg Cap Option - Aluminum: **Add 310.00**

DESCRIPTION MODEL# STANDARD FABRIC GRADES

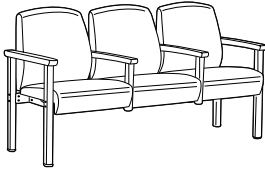

Medium Back Three Seat Chair Half Center Arm
 COM Yardage: 5.50
 Freight Class: 250
 Product Weight (lbs.): 141
 Cubic Feet Per Carton: 65.25

Aluminum Arms/Leg Frame
 Armcap/Leg Cap Black Urethane: No Upcharge
 Armcap Option - Wood: **Add 189.00**
 Leg Cap Option - Wood: **Add 237.00**
 Leg Cap Option - Aluminum: **Add 402.00**

| COM | 2 | 3 | 4 | 5 | 6 | 7 | 8 | 9 | 10 | 11 | 12 |
|---------------|---------------|---------------|---------------|---------------|---------------|---------------|---------------|---------------|---------------|---------------|---------------|
| \$3062 | \$3190 | \$3294 | \$3448 | \$3666 | \$3749 | \$3941 | \$4301 | \$4481 | \$4816 | \$5281 | \$5281 |

| OVERALL DIMENSIONS | | | SEAT DIMENSIONS | | | BACK DIMENSIONS | |
|--------------------|----|----|-----------------|----|------|-----------------|------|
| W | D | H | W | D | H | W | H |
| 71 | 25 | 37 | 21.5 | 18 | 18.5 | 19.5 | 18.5 |



High Back Three Seat Chair Half Center Arm
 COM Yardage: 6.50
 Freight Class: 300
 Product Weight (lbs.): 153
 Cubic Feet Per Carton: 80.75

Aluminum Arms/Leg Frame
 Armcap/Leg Cap Black Urethane: No Upcharge
 Armcap Option - Wood: **Add 189.00**
 Leg Cap Option - Wood: **Add 237.00**
 Leg Cap Option - Aluminum: **Add 402.00**

| COM | 2 | 3 | 4 | 5 | 6 | 7 | 8 | 9 | 10 | 11 | 12 |
|---------------|---------------|---------------|---------------|---------------|---------------|---------------|---------------|---------------|---------------|---------------|---------------|
| \$3266 | \$3418 | \$3540 | \$3723 | \$3981 | \$4079 | \$4305 | \$4731 | \$4944 | \$5339 | \$5889 | \$5889 |

| OVERALL DIMENSIONS | | | SEAT DIMENSIONS | | | BACK DIMENSIONS | |
|--------------------|----|----|-----------------|----|------|-----------------|------|
| W | D | H | W | D | H | W | H |
| 71 | 25 | 37 | 21.5 | 18 | 18.5 | 19.5 | 18.5 |

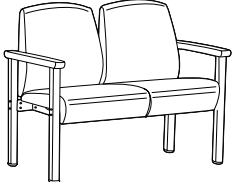

Medium Back Two Seat Chair No Center Arm
 COM Yardage: 3.75
 Freight Class: 250
 Product Weight (lbs.): 98
 Cubic Feet Per Carton: 45.75

Aluminum Arms/Leg Frame
 Armcap/Leg Cap Black Urethane: No Upcharge
 Armcap Option - Wood: **Add 97.00**
 Leg Cap Option - Wood: **Add 120.00**
 Leg Cap Option - Aluminum: **Add 217.00**

| COM | 2 | 3 | 4 | 5 | 6 | 7 | 8 | 9 | 10 | 11 | 12 |
|---------------|---------------|---------------|---------------|---------------|---------------|---------------|---------------|---------------|---------------|---------------|---------------|
| \$1816 | \$1903 | \$1974 | \$2079 | \$2228 | \$2285 | \$2415 | \$2661 | \$2784 | \$3012 | \$3329 | \$3329 |

| OVERALL DIMENSIONS | | | SEAT DIMENSIONS | | | BACK DIMENSIONS | |
|--------------------|----|----|-----------------|----|------|-----------------|------|
| W | D | H | W | D | H | W | H |
| 46.5 | 25 | 37 | 43 | 18 | 18.5 | 39 | 18.5 |

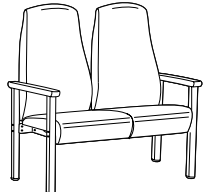

High Back Two Seat Chair No Center Arm
 COM Yardage: 4.25
 Freight Class: 300
 Product Weight (lbs.): 102
 Cubic Feet Per Carton: 56.50

Aluminum Arms/Leg Frame
 Armcap/Leg Cap Black Urethane: No Upcharge
 Armcap Option - Wood: **Add 98.00**
 Leg Cap Option - Wood: **Add 123.00**
 Leg Cap Option - Aluminum: **Add 220.00**

| COM | 2 | 3 | 4 | 5 | 6 | 7 | 8 | 9 | 10 | 11 | 12 |
|---------------|---------------|---------------|---------------|---------------|---------------|---------------|---------------|---------------|---------------|---------------|---------------|
| \$1947 | \$2046 | \$2126 | \$2245 | \$2414 | \$2478 | \$2626 | \$2905 | \$3044 | \$3302 | \$3662 | \$3662 |

| OVERALL DIMENSIONS | | | SEAT DIMENSIONS | | | BACK DIMENSIONS | |
|--------------------|----|------|-----------------|----|------|-----------------|----|
| W | D | H | W | D | H | W | H |
| 46.5 | 25 | 46.5 | 43 | 18 | 18.5 | 39 | 28 |

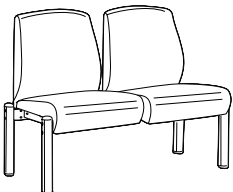

Medium Back Two Seat Chair Armless
 COM Yardage: 3.75
 Freight Class: 300
 Product Weight (lbs.): 86
 Cubic Feet Per Carton: 45.75

Aluminum Leg Frame
 Leg Cap Black Urethane: No Upcharge
 Leg Cap Option - Wood: **Add 120.00**
 Leg Cap Option - Aluminum: **Add 189.00**

| COM | 2 | 3 | 4 | 5 | 6 | 7 | 8 | 9 | 10 | 11 | 12 |
|---------------|---------------|---------------|---------------|---------------|---------------|---------------|---------------|---------------|---------------|---------------|---------------|
| \$1581 | \$1668 | \$1739 | \$1844 | \$1993 | \$2050 | \$2180 | \$2426 | \$2548 | \$2777 | \$3094 | \$3094 |

| OVERALL DIMENSIONS | | | SEAT DIMENSIONS | | | BACK DIMENSIONS | |
|--------------------|----|----|-----------------|----|------|-----------------|------|
| W | D | H | W | D | H | W | H |
| 45.5 | 25 | 37 | 43 | 18 | 18.5 | 39 | 18.5 |

| DESCRIPTION | MODEL# | STANDARD FABRIC GRADES | | | | | | | | | | | |
|-------------|--------|------------------------|---|---|---|---|---|---|---|---|----|----|----|
| | | COM | 2 | 3 | 4 | 5 | 6 | 7 | 8 | 9 | 10 | 11 | 12 |

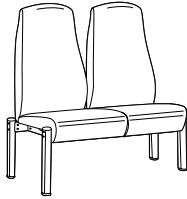

GC4118HBNA

| | | | | | | | | | | | |
|--------|--------|--------|--------|--------|--------|--------|--------|--------|--------|--------|--------|
| COM | 2 | 3 | 4 | 5 | 6 | 7 | 8 | 9 | 10 | 11 | 12 |
| \$1711 | \$1810 | \$1890 | \$2009 | \$2178 | \$2242 | \$2390 | \$2669 | \$2808 | \$3066 | \$3426 | \$3426 |

| OVERALL DIMENSIONS | | | SEAT DIMENSIONS | | | BACK DIMENSIONS | |
|--------------------|---|---|-----------------|---|---|-----------------|---|
| W | D | H | W | D | H | W | H |

| | | | | | | | |
|------|----|------|----|----|------|----|----|
| 45.5 | 25 | 46.5 | 43 | 18 | 18.5 | 39 | 28 |
|------|----|------|----|----|------|----|----|

High Back Two Seat Chair Armless
 COM Yardage: 4.25
 Freight Class: 300
 Product Weight (lbs.): 90
 Cubic Feet Per Carton: 56.50

Aluminum Leg Frame
 Leg Cap Black Urethane: No Upcharge
 Leg Cap Option - Wood: **Add 123.00**
 Leg Cap Option - Aluminum: **Add 194.00**

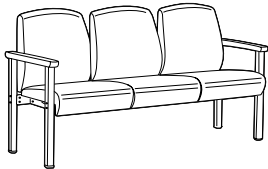

GC4119

| | | | | | | | | | | | |
|--------|--------|--------|--------|--------|--------|--------|--------|--------|--------|--------|--------|
| COM | 2 | 3 | 4 | 5 | 6 | 7 | 8 | 9 | 10 | 11 | 12 |
| \$2467 | \$2595 | \$2699 | \$2853 | \$3072 | \$3154 | \$3346 | \$3706 | \$3886 | \$4221 | \$4686 | \$4686 |

| OVERALL DIMENSIONS | | | SEAT DIMENSIONS | | | BACK DIMENSIONS | |
|--------------------|---|---|-----------------|---|---|-----------------|---|
| W | D | H | W | D | H | W | H |

| | | | | | | | |
|----|----|----|------|----|------|------|------|
| 68 | 25 | 37 | 64.5 | 18 | 18.5 | 60.5 | 18.5 |
|----|----|----|------|----|------|------|------|

Medium Back Three Seat Chair No Center Arm
 COM Yardage: 5.50
 Freight Class: 250
 Product Weight (lbs.): 135
 Cubic Feet Per Carton: 65.25

Aluminum Arms/Leg Frame
 Armcap/Leg Cap Black Urethane: No Upcharge
 Armcap Option - Wood: **Add 97.00**
 Leg Cap Option - Wood: **Add 120.00**
 Leg Cap Option - Aluminum: **Add 217.00**

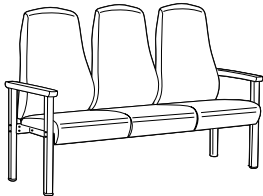

GC4119HB

| | | | | | | | | | | | |
|--------|--------|--------|--------|--------|--------|--------|--------|--------|--------|--------|--------|
| COM | 2 | 3 | 4 | 5 | 6 | 7 | 8 | 9 | 10 | 11 | 12 |
| \$2670 | \$2822 | \$2944 | \$3127 | \$3385 | \$3483 | \$3709 | \$4135 | \$4348 | \$4743 | \$5293 | \$5293 |

| OVERALL DIMENSIONS | | | SEAT DIMENSIONS | | | BACK DIMENSIONS | |
|--------------------|---|---|-----------------|---|---|-----------------|---|
| W | D | H | W | D | H | W | H |

| | | | | | | | |
|----|----|------|------|----|------|------|----|
| 68 | 25 | 46.5 | 64.5 | 18 | 18.5 | 60.5 | 28 |
|----|----|------|------|----|------|------|----|

High Back Three Seat Chair No Center Arm
 COM Yardage: 6.50
 Freight Class: 300
 Product Weight (lbs.): 141
 Cubic Feet Per Carton: 80.75

Aluminum Arms/Leg Frame
 Armcap/Leg Cap Black Urethane: No Upcharge
 Armcap Option - Wood: **Add 98.00**
 Leg Cap Option - Wood: **Add 123.00**
 Leg Cap Option - Aluminum: **Add 220.00**

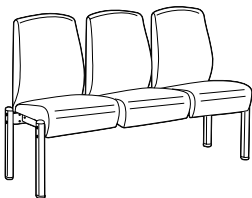

GC4119NA

| | | | | | | | | | | | |
|--------|--------|--------|--------|--------|--------|--------|--------|--------|--------|--------|--------|
| COM | 2 | 3 | 4 | 5 | 6 | 7 | 8 | 9 | 10 | 11 | 12 |
| \$2232 | \$2360 | \$2464 | \$2618 | \$2836 | \$2919 | \$3111 | \$3471 | \$3651 | \$3986 | \$4451 | \$4451 |

| OVERALL DIMENSIONS | | | SEAT DIMENSIONS | | | BACK DIMENSIONS | |
|--------------------|---|---|-----------------|---|---|-----------------|---|
| W | D | H | W | D | H | W | H |

| | | | | | | | |
|----|----|----|------|----|------|------|------|
| 67 | 25 | 37 | 64.5 | 18 | 18.5 | 60.5 | 18.5 |
|----|----|----|------|----|------|------|------|

Medium Back Three Seat Chair Armless
 COM Yardage: 5.50
 Freight Class: 300
 Product Weight (lbs.): 123
 Cubic Feet Per Carton: 65.25

Aluminum Leg Frame
 Leg Cap Black Urethane: No Upcharge
 Leg Cap Option - Wood: **Add 120.00**
 Leg Cap Option - Aluminum: **Add 189.00**

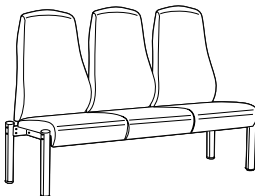

GC4119HBNA

| | | | | | | | | | | | |
|--------|--------|--------|--------|--------|--------|--------|--------|--------|--------|--------|--------|
| COM | 2 | 3 | 4 | 5 | 6 | 7 | 8 | 9 | 10 | 11 | 12 |
| \$2436 | \$2587 | \$2709 | \$2892 | \$3150 | \$3248 | \$3474 | \$3900 | \$4113 | \$4508 | \$5058 | \$5058 |

| OVERALL DIMENSIONS | | | SEAT DIMENSIONS | | | BACK DIMENSIONS | |
|--------------------|---|---|-----------------|---|---|-----------------|---|
| W | D | H | W | D | H | W | H |

| | | | | | | | |
|----|----|------|------|----|------|------|----|
| 67 | 25 | 46.5 | 64.5 | 18 | 18.5 | 60.5 | 28 |
|----|----|------|------|----|------|------|----|

High Back Three Seat Chair Armless
 COM Yardage: 6.50
 Freight Class: 300
 Product Weight (lbs.): 137
 Cubic Feet Per Carton: 80.75

Aluminum Leg Frame
 Leg Cap Black Urethane: No Upcharge
 Leg Cap Option - Wood: **Add 124.00**
 Leg Cap Option - Aluminum: **Add 189.00**

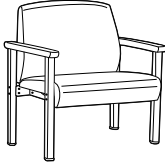
| DESCRIPTION | MODEL# | STANDARD FABRIC GRADES | | | | | | | | | | | |
|--|--------|---|--------|--------|---------------------------------|--------|--------|-------------------------------|--------|--------|--------|--------|--------|
| | | COM | 2 | 3 | 4 | 5 | 6 | 7 | 8 | 9 | 10 | 11 | 12 |
|  <p>Bariatric Medium Back Single Seat Armchair COM Yardage: 3.75 Freight Class: 250 Product Weight (lbs.): 74 Cubic Feet Per Carton: 26.50</p> | GC4125 | \$1550 | \$1624 | \$1768 | \$1861 | \$1992 | \$2062 | \$2184 | \$2361 | \$2526 | \$2670 | \$3036 | \$3036 |
| | | OVERALL DIMENSIONS W D H | | | SEAT DIMENSIONS W D H | | | BACK DIMENSIONS W H | | | | | |
| <p>Aluminum Arms/Leg Frame Armcap/Leg Cap Black Urethane: No Upcharge Armcap Option - Wood: Add 98.00 Leg Cap Option - Wood: Add 123.00 Leg Cap Option - Aluminum: Add 220.00</p> | | 35 | 25 | 37 | | 31.5 | 18 | 18.5 | | 30 | 18.5 | | |
| | | • For users up to 750 lbs. Armless Bariatric models are <u>not</u> available. | | | | | | | | | | | |

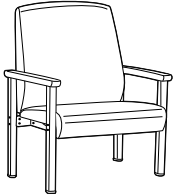
| | | | | | | | | | | | | | |
|--|----------|---|--------|--------|---------------------------------|--------|--------|-------------------------------|--------|--------|--------|--------|--------|
|  <p>Bariatric High Back Single Seat Armchair COM Yardage: 4.50 Freight Class: 250 Product Weight (lbs.): 80 Cubic Feet Per Carton: 30.50</p> | GC4125HB | \$1627 | \$1714 | \$1876 | \$1987 | \$2144 | \$2228 | \$2374 | \$2587 | \$2785 | \$2958 | \$3396 | \$3396 |
| | | OVERALL DIMENSIONS W D H | | | SEAT DIMENSIONS W D H | | | BACK DIMENSIONS W H | | | | | |
| <p>Aluminum Arms/Leg Frame Armcap/Leg Cap Black Urethane: No Upcharge Armcap Option - Wood: Add 98.00 Leg Cap Option - Wood: Add 123.00 Leg Cap Option - Aluminum: Add 220.00</p> | | 35 | 25 | 43 | | 31.5 | 18 | 18.5 | | 30 | 24.5 | | |
| | | • For users up to 750 lbs. Armless Bariatric models are <u>not</u> available. | | | | | | | | | | | |

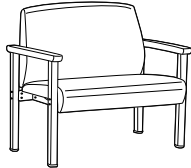
| | | | | | | | | | | | | | |
|---|--------|---|--------|--------|---------------------------------|--------|--------|-------------------------------|--------|--------|--------|--------|--------|
|  <p>Bariatric Medium Back Single Seat Armchair COM Yardage: 3.75 Freight Class: 300 Product Weight (lbs.): 90 Cubic Feet Per Carton: 45.75</p> | GC4135 | \$1964 | \$2051 | \$2122 | \$2226 | \$2376 | \$2432 | \$2563 | \$2808 | \$2932 | \$3160 | \$3476 | \$3476 |
| | | OVERALL DIMENSIONS W D H | | | SEAT DIMENSIONS W D H | | | BACK DIMENSIONS W H | | | | | |
| <p>Aluminum Arms/Leg Frame Armcap/Leg Cap Black Urethane: No Upcharge Armcap Option - Wood: Add 98.00 Leg Cap Option - Wood: Add 123.00 Leg Cap Option - Aluminum: Add 220.00</p> | | 46.5 | 25 | 37 | | 41.5 | 18 | 18.5 | | 41 | 18.5 | | |
| | | • For users up to 750 lbs. Armless Bariatric models are <u>not</u> available. | | | | | | | | | | | |

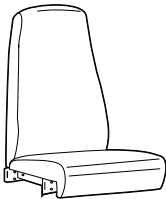
| | | | | | | | | | | | | | |
|--|-----------|------------------------------------|-------|-------|---------------------------------|--------|--------|-------------------------------|--------|--------|--------|--------|--------|
|  <p>High Back Single Seat Armless Top COM Yardage: 2 Freight Class: 150 Product Weight (lbs.): 38 Cubic Feet Per Carton: 9</p> | GC4101TOP | \$808 | \$847 | \$921 | \$972 | \$1042 | \$1080 | \$1145 | \$1240 | \$1327 | \$1404 | \$1598 | \$1598 |
| | | OVERALL DIMENSIONS W D H | | | SEAT DIMENSIONS W D H | | | BACK DIMENSIONS W H | | | | | |
| <p>All hardware required for assembly of this unit is included.</p> | | 21.5 | 23 | 30 | | 21.5 | 18 | -- | | 19.5 | 28 | | |

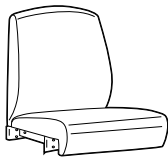
| | | | | | | | | | | | | | |
|--|-----------|------------------------------------|-------|-------|---------------------------------|-------|-------|-------------------------------|--------|--------|--------|--------|--------|
|  <p>Medium Back Single Seat Armless Top COM Yardage: 1.75 Freight Class: 150 Product Weight (lbs.): 36 Cubic Feet Per Carton: 7.50</p> | GC4105TOP | \$754 | \$787 | \$855 | \$899 | \$960 | \$993 | \$1049 | \$1133 | \$1211 | \$1279 | \$1447 | \$1447 |
| | | OVERALL DIMENSIONS W D H | | | SEAT DIMENSIONS W D H | | | BACK DIMENSIONS W H | | | | | |
| <p>All hardware required for assembly of this unit is included.</p> | | 21.5 | 23 | 20.5 | | 21.5 | 18 | -- | | 19.5 | 18.5 | | |

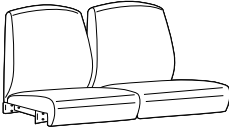
| DESCRIPTION | MODEL# | STANDARD FABRIC GRADES | | | | | | | | | | | |
|--|---------------------------|------------------------|----------|------------------------|----------|----------|------------------------|----------|--------|--------|--------|--------|--------|
| | | COM | 2 | 3 | 4 | 5 | 6 | 7 | 8 | 9 | 10 | 11 | 12 |
|  <p>Medium Back Two Seat Armless Top COM Yardage: 3.75 Freight Class: 150 Product Weight (lbs.): 75 Cubic Feet Per Carton: 13.50</p> | GC4118TOP | \$1443 | \$1530 | \$1601 | \$1706 | \$1855 | \$1912 | \$2042 | \$2288 | \$2410 | \$2639 | \$2956 | \$2956 |
| | OVERALL DIMENSIONS | | | SEAT DIMENSIONS | | | BACK DIMENSIONS | | | | | | |
| | W | D | H | W | D | H | W | H | | | | | |
| | 43 | 23 | 20.5 | 43 | 18 | -- | 39 | 18.5 | | | | | |

All hardware required for assembly of this unit is included.

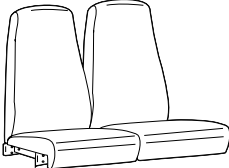
| | | | | | | | | | | | | | |
|---|---------------------------|----------|----------|------------------------|----------|----------|------------------------|----------|--------|--------|--------|--------|--------|
|  <p>High Back Two Seat Armless Top COM Yardage: 4.25 Freight Class: 150 Product Weight (lbs.): 83 Cubic Feet Per Carton: 16</p> | GC4118HBTOP | \$1549 | \$1648 | \$1728 | \$1847 | \$2016 | \$2080 | \$2228 | \$2507 | \$2646 | \$2904 | \$3264 | \$3264 |
| | OVERALL DIMENSIONS | | | SEAT DIMENSIONS | | | BACK DIMENSIONS | | | | | | |
| | W | D | H | W | D | H | W | H | | | | | |
| | 43 | 23 | 30 | 43 | 18 | -- | 39 | 28 | | | | | |

All hardware required for assembly of this unit is included.

| | | | | | | | | | | | | | |
|---|---------------------------|----------|----------|------------------------|----------|----------|------------------------|----------|--------|--------|--------|--------|--------|
|  <p>Medium Back Three Seat Armless Top COM Yardage: 5.50 Freight Class: 150 Product Weight (lbs.): 86 Cubic Feet Per Carton: 19.50</p> | GC4119TOP | \$2156 | \$2284 | \$2388 | \$2542 | \$2760 | \$2843 | \$3035 | \$3395 | \$3575 | \$3910 | \$4375 | \$4375 |
| | OVERALL DIMENSIONS | | | SEAT DIMENSIONS | | | BACK DIMENSIONS | | | | | | |
| | W | D | H | W | D | H | W | H | | | | | |
| | 64.5 | 23 | 20.5 | 64.5 | 18 | -- | 60.5 | 18.5 | | | | | |

All hardware required for assembly of this unit is included.

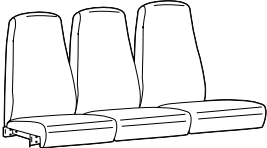
| | | | | | | | | | | | | | |
|--|---------------------------|----------|----------|------------------------|----------|----------|------------------------|----------|--------|--------|--------|--------|--------|
|  <p>High Back Three Seat Armless Top COM Yardage: 6.50 Freight Class: 150 Product Weight (lbs.): 113 Cubic Feet Per Carton: 23</p> | GC4119HBTOP | \$2362 | \$2513 | \$2635 | \$2818 | \$3076 | \$3174 | \$3400 | \$3826 | \$4039 | \$4434 | \$4984 | \$4984 |
| | OVERALL DIMENSIONS | | | SEAT DIMENSIONS | | | BACK DIMENSIONS | | | | | | |
| | W | D | H | W | D | H | W | H | | | | | |
| | 64.5 | 23 | 30 | 64.5 | 18 | -- | 60.5 | 28 | | | | | |

All hardware required for assembly of this unit is included.

| | | | | | | | | | | | | | |
|--|---------------------------|----------|----------|------------------------|----------|----------|------------------------|----------|--------|--------|--------|--------|--------|
|  <p>Bariatric Medium Back Single Seat Armless Top COM Yardage: 3.75 Freight Class: 150 Product Weight (lbs.): 55 Cubic Feet Per Carton: 10</p> | GC4125TOP | \$1094 | \$1169 | \$1286 | \$1381 | \$1513 | \$1584 | \$1704 | \$1881 | \$2047 | \$2447 | \$2556 | \$2556 |
| | OVERALL DIMENSIONS | | | SEAT DIMENSIONS | | | BACK DIMENSIONS | | | | | | |
| | W | D | H | W | D | H | W | H | | | | | |
| | 31.5 | 23 | 20.5 | 31.5 | 18 | -- | 30 | 18.5 | | | | | |

All hardware required for assembly of this unit is included.

• **Must be connected to a full arm/leg frame**

| DESCRIPTION | MODEL# | STANDARD FABRIC GRADES | | | | | | | | | | | |
|--|---------------------------|------------------------|----------|------------------------|----------|----------|------------------------|----------|--------|--------|--------|--------|--------|
| | | COM | 2 | 3 | 4 | 5 | 6 | 7 | 8 | 9 | 10 | 11 | 12 |
|  <p>Bariatric High Back Single Seat Armless Top COM Yardage: 4.50 Freight Class: 150 Product Weight (lbs.): 60 Cubic Feet Per Carton: 12</p> | GC4125HBTOP | \$1170 | \$1258 | \$1397 | \$1507 | \$1664 | \$1749 | \$1894 | \$2107 | \$2307 | \$2478 | \$2916 | \$2916 |
| | OVERALL DIMENSIONS | | | SEAT DIMENSIONS | | | BACK DIMENSIONS | | | | | | |
| | W | D | H | W | D | H | W | H | | | | | |
| | | | | | | | | | | | | | |
| | | | | | | | | | | | | | |

All hardware required for assembly of this unit is included.
 • **Must be connected to a full arm/leg frame**

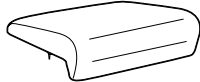
| DESCRIPTION | MODEL# | STANDARD FABRIC GRADES | | | | | | | | | | | |
|--|---------------------------|------------------------|----------|------------------------|----------|----------|------------------------|----------|-------|-------|-------|-------|-------|
| | | COM | 2 | 3 | 4 | 5 | 6 | 7 | 8 | 9 | 10 | 11 | 12 |
|  <p>Seat Cushion COM Yardage: 1.50 Freight Class: 250 Product Weight (lbs.): 6 Cubic Feet Per Carton: 2.90</p> | GC4110ST | \$184 | \$219 | \$248 | \$290 | \$349 | \$372 | \$424 | \$522 | \$572 | \$663 | \$790 | \$790 |
| | OVERALL DIMENSIONS | | | SEAT DIMENSIONS | | | BACK DIMENSIONS | | | | | | |
| | W | D | H | W | D | H | W | H | | | | | |
| | | | | | | | | | | | | | |
| | | | | | | | | | | | | | |

Velcro fasteners for attachment to seat frame are standard.
 • Frame not included. Must be ordered separately.

| DESCRIPTION | MODEL# | STANDARD FABRIC GRADES | | | | | | | | | | | |
|---|---------------------------|------------------------|----------|------------------------|----------|----------|------------------------|----------|-------|-------|-------|-------|-------|
| | | COM | 2 | 3 | 4 | 5 | 6 | 7 | 8 | 9 | 10 | 11 | 12 |
|  <p>Bariatric Seat Cushion COM Yardage: 1.75 Freight Class: 300 Product Weight (lbs.): 8 Cubic Feet Per Carton: 5.50</p> | GC4125ST | \$261 | \$295 | \$340 | \$383 | \$445 | \$476 | \$534 | \$617 | \$692 | \$761 | \$931 | \$931 |
| | OVERALL DIMENSIONS | | | SEAT DIMENSIONS | | | BACK DIMENSIONS | | | | | | |
| | W | D | H | W | D | H | W | H | | | | | |
| | | | | | | | | | | | | | |
| | | | | | | | | | | | | | |

Velcro fasteners for attachment to seat frame are standard.
 • Frame not included. Must be ordered separately.

| DESCRIPTION | MODEL# | STANDARD FABRIC GRADES | | | | | | | | | | | |
|--|---------------------------|------------------------|----------|------------------------|----------|----------|------------------------|----------|-------|-------|-------|-------|-------|
| | | COM | 2 | 3 | 4 | 5 | 6 | 7 | 8 | 9 | 10 | 11 | 12 |
|  <p>High Back Cushion COM Yardage: 1.25 Freight Class: 125 Product Weight (lbs.): 18 Cubic Feet Per Carton: 2.90</p> | GC4111HB | \$311 | \$335 | \$374 | \$404 | \$448 | \$472 | \$513 | \$571 | \$626 | \$675 | \$796 | \$796 |
| | OVERALL DIMENSIONS | | | SEAT DIMENSIONS | | | BACK DIMENSIONS | | | | | | |
| | W | D | H | W | D | H | W | H | | | | | |
| | | | | | | | | | | | | | |
| | | | | | | | | | | | | | |

Velcro fasteners for attachment to seat frame are standard.

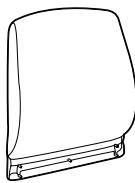
| DESCRIPTION | MODEL# | STANDARD FABRIC GRADES | | | | | | | | | | | |
|---|---------------------------|------------------------|----------|------------------------|----------|----------|------------------------|----------|-------|-------|-------|-------|-------|
| | | COM | 2 | 3 | 4 | 5 | 6 | 7 | 8 | 9 | 10 | 11 | 12 |
|  <p>Medium Back Cushion COM Yardage: 1 Freight Class: 150 Product Weight (lbs.): 15 Cubic Feet Per Carton: 2.90</p> | GC4111MB | \$258 | \$276 | \$307 | \$333 | \$366 | \$386 | \$417 | \$466 | \$510 | \$547 | \$644 | \$644 |
| | OVERALL DIMENSIONS | | | SEAT DIMENSIONS | | | BACK DIMENSIONS | | | | | | |
| | W | D | H | W | D | H | W | H | | | | | |
| | | | | | | | | | | | | | |
| | | | | | | | | | | | | | |

Velcro fasteners for attachment to seat frame are standard.

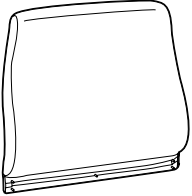
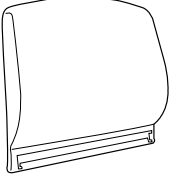
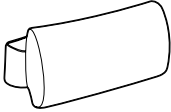
| DESCRIPTION | MODEL# | STANDARD FABRIC GRADES | | | | | | | | | | | |
|--|------------|------------------------|-------|-------|---|-------|-------|-----------------|-------|-------|--------|--------|--------|
| | | COM | 2 | 3 | 4 | 5 | 6 | 7 | 8 | 9 | 10 | 11 | 12 |
|  <p>Bariatric High Back Cushion COM Yardage: 2 Freight Class: 150 Product Weight (lbs.): 24 Cubic Feet Per Carton: 4.30</p> | GC4125HBBC | \$464 | \$510 | \$548 | \$604 | \$684 | \$714 | \$783 | \$914 | \$980 | \$1102 | \$1271 | \$1271 |
| | | OVERALL DIMENSIONS | | | SEAT DIMENSIONS | | | BACK DIMENSIONS | | | | | |
| | | W | D | H | W | D | H | W | H | | | | |
| | | 30 | 5.75 | 24.5 | Velcro fasteners for attachment to seat frame are standard. | | | | | | | | |
|  <p>Bariatric Medium Back Cushion COM Yardage: 1.75 Freight Class: 150 Product Weight (lbs.): 23 Cubic Feet Per Carton: 5.50</p> | GC4125MB | \$396 | \$436 | \$469 | \$518 | \$588 | \$614 | \$675 | \$790 | \$847 | \$954 | \$1102 | \$1102 |
| | | OVERALL DIMENSIONS | | | SEAT DIMENSIONS | | | BACK DIMENSIONS | | | | | |
| | | W | D | H | W | D | H | W | H | | | | |
| | | 30 | 5.75 | 24.5 | Velcro fasteners for attachment to seat frame are standard. | | | | | | | | |
|  <p>Headrest COM Yardage: .75 Freight Class: 70 Product Weight (lbs.): 1 Cubic Feet Per Carton: .40</p> | GC4139 | \$116 | \$130 | \$150 | \$168 | \$195 | \$209 | \$232 | \$270 | \$301 | \$332 | \$403 | \$403 |
| | | OVERALL DIMENSIONS | | | SEAT DIMENSIONS | | | BACK DIMENSIONS | | | | | |
| | | W | D | H | W | D | H | W | H | | | | |
| | | 15.5 | 7 | 3 | For Interlock High Back Models. Adjustable elastic band. | | | | | | | | |

| SEATING COMPONENT PARTS | MODEL# | DIMENSIONS | FREIGHT CLASS | WT/LBS. | CUBIC FT. | LIST PRICE |
|---|---------------------------|-------------------|---------------|---------|-----------|--------------|
|  | GC4101S1 (single seat) | 21 x 19.5 x 2.5 | 65 | 18 | .80 | \$404 |
| | GC4116S2 (two seat) | 42.5 x 19.5 x 2.5 | 65 | 36 | 1.60 | \$706 |

Seat Frame

For seating units. Mounting hardware for all 4 sides are included. Tungsten finish.
 • Seat cushion(s) not included. Must be ordered separately.

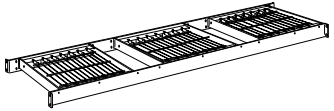
| | | | | | | |
|---|--------------------------|-----------------|----|----|------|---------------|
|  | GC4117S3 (three seat) | 64 x 19.5 x 2.5 | 70 | 52 | 2.40 | \$1052 |
|---|--------------------------|-----------------|----|----|------|---------------|

Seat Frame

For seating units. Mounting hardware for all 4 sides are included. Tungsten finish.
 • Seat cushion(s) not included. Must be ordered separately.

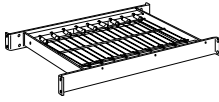
| | | | | | | |
|--|---------------------------|-----------------|----|----|------|--------------|
|  | GC4125S1 (single seat) | 31 x 19.5 x 2.5 | 65 | 27 | 1.20 | \$493 |
|--|---------------------------|-----------------|----|----|------|--------------|

Bariatric Seat Frame

For Bariatric seating units. Mounting hardware for all 4 sides are included. Tungsten finish.
 • Seat cushion(s) not included. Must be ordered separately.
 • Must be linked using full height frame only

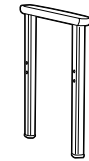
| | | | | | | |
|---|----------|-------------------|-----|----|------|--------------|
|  | GC4101FA | 2.5 x 23.5 x 26.5 | 100 | 11 | 1.20 | \$335 |
|---|----------|-------------------|-----|----|------|--------------|

Arm and Leg Frame - Aluminum
Full Height, Outside Position

For seating units only. Complete arm and leg frame. For use in a **linking** position (seat, bench or table frames can attach to this unit). Black SSU armcap. Aluminum legs with Black PVC front half leg cap.
 • Arm Cap/Leg Cap Black Urethane: No Upcharge
 • Arm Cap Option - Wood: Add 47.00.
 • Leg Cap Option - Wood: Add 31.00.
 • Leg Cap Option - Aluminum: Add 95.00.

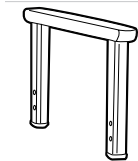
| | | | | | | |
|---|----------|-----------------|------|---|-----|--------------|
|  | GC4112HA | 2.5 x 23.5 x 15 | 92.5 | 7 | .70 | \$276 |
|---|----------|-----------------|------|---|-----|--------------|

Arm Frame - Aluminum
Half Height, Connecting Position

Complete upper arm frame with black SSU armcap. For use in a **linking** position (seat, bench or table frames can attach to this unit). Must be used when linking 2 frames with no lower legs. *Cannot be used on one piece multiple frame units.*
 • Arm Cap/Leg Cap Black Urethane: No Upcharge
 • Arm Cap Option - Wood: **Add 50.00**
 • Leg Cap Option - Wood: **Add 33.00**
 • Leg Cap Option - Aluminum: **Add 100.00**

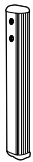
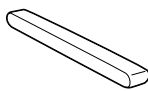
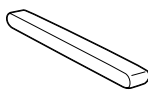
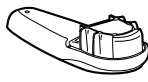
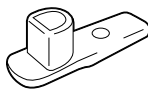
| SEATING COMPONENT PARTS | MODEL# | DIMENSIONS | FREIGHT CLASS | WT/LBS. | CUBIC FT. | LIST PRICE |
|---|-----------|-------------------|---------------|---------|-----------|--------------|
|  <p>Leg - Aluminum, Half Height, Connecting Position</p> <p>For all seat or bench frames. Complete armless lower leg. Aluminum leg with Black PVC front leg cap. Hardware included. For use in a linking position.</p> <ul style="list-style-type: none"> • Leg Cap Black Urethane: No Upcharge • Leg Cap Option - Wood: Add 33.00 • Leg Cap Option - Aluminum: Add 51.00 | GC4120SL | 1.75 x 2.5 x 15 | 70 | 4 | .20 | \$100 |
|  <p>Armcap - Urethane</p> <p>Self-skinned urethane (SSU) armcap in Black only. Hardware included.</p> <ul style="list-style-type: none"> • No charge if ordered as a substitute for wood armcap when ordering a complete arm frame unit | GC4137 | 2.5 x 23.5 x 1.75 | 70 | 3 | .20 | \$79 |
|  <p>Armcap - Wood</p> <p>Solid wood armcap. Hardware included.</p> <ul style="list-style-type: none"> • Available in a variety of wood finishes | GC4138 | 2.5 x 23.5 x 1.75 | 70 | 3 | .20 | \$115 |
|  <p>Wallsaver Glide</p> <p>For back legs. Keeps chair from touching the wall. Sold individually.</p> <ul style="list-style-type: none"> • Available on Aluminum arm/leg frame models only | GC4101WSG | 1.75 x 5.75 x 1 | 70 | 1 | .20 | \$36 |
|  <p>Floor Mount Bracket</p> <p>For Aluminum framed units only. Keeps chair anchored to the floor. Sold as a pair.</p> | GC4101FMG | 1.75 x 5.75 x 2 | 70 | 1 | .20 | \$84 |

INTERLOCK - BENCHES



model GC4132

model GC4134CT

Shown with urethane leg caps in Silver (AU - optional)

FEATURES

- Single, two or three seater frames can be used as a stand alone bench or can connect to seating, bench or table options (Aluminum frame models only).
- Bench units have no front or back facing distinction.
- Maximum seat run without center support legs is three.
- Tablet Tops (for use in linked applications) are 1" thick and available in the following high pressure laminates with matching 3mm PVC edge; Avant Cherry (W357), Avant Honey (W356), Brushed Cobalt (BCH), Clear Maple (CMB), Constellation Java (CJH), Dark Espresso (W142), Empire Mahogany (EMB), Quartered

Mahogany (W313), Shaker Cherry (SKB), Tiger Fruitwood (W821), Tiger Maple (W820), and Tiger Walnut (W819).

- High density Ultracell foam is standard. Moisture Barrier - Seat Only - **Add \$85.00** list upcharge per seat.
- For addition of a Fire Barrier Lining - **Add \$65.00** list upcharge per yard.
- Call Customer Care for **CAL133** approved textiles.

SUGGESTED APPLICATIONS

- Waiting Areas
- Lobbies

ALUMINUM ARM AND LEG FRAME INSERT OPTIONS

- Aluminum arm/leg frames are available in Platinum (PLT), Toast (TOA), Tungsten (TUN), Cappuccino (T20), Mocha (J52) and Kalua (KAL). Please Specify.
- **Leg Cap:** The Half-Leg option refers to the armless leg. The **Full Leg** option refers to the arm and leg combination (with standard black, urethane armcap).
Standard - Urethane Ribbed Leg Insert - Available in Black (BK) Only.
Aluminum Ribbed Leg Inserts are available in - Silver (AU), Champagne (CP) and Bronze (LB).
Non-Ribbed Leg Inserts are available in - Silver (PS), Platinum (PLT), Toast (TOA), Cappuccino (T20), Mocha (J52) and Kalua (KAL).
See individual models for specific upcharge. MUST Specify Ribbed or Non-Ribbed when ordering.
- Wood - Available in the following finishes; Absolute (AAM), Brandy Peppercorn (BPM), Charcoal Java (CJM), Cherry (ACM), Cherry Latte (CLM), Cocoa Vanilla (CVM), Empire Mahogany (EMM), English Oak (EOM), Espresso Cafe (ECM), Fruitwood (TFM), Gray (HGM), Harvest Oak (HOM), Honey (AHM), Jet Onyx (JOM), Light Honey (LHM), Mahogany (TMM), Maple (AVM), Medium Walnut (MVM), Night (ASM), Sandy Beach (SBM), Shaker Cherry (SKM), Silver Oak (SOM), Walnut (TWM), White (WHM), WC Cream (WTM) and Winter Cherry (WCM). **See individual models for specific upcharge.**
- Maple faced veneers and solids are used for all finishes.

STANDARD



Armcap - Black Self-Skinned Urethane
Leg Cap - Black (Ribbed), PVC front leg cap

OPTION



Armcap - Black Self-Skinned Urethane
Leg Cap - Aluminum (Ribbed or non-Ribbed - Silver only) front leg cap

OPTION



Armcap - Wood
Leg Cap - Wood, front leg cap

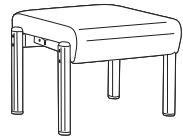

Single Seat Bench

COM Yardage: 1.50
Freight Class: 150
Product Weight (lbs.): 34
Cubic Feet Per Carton: 8.50

Aluminum Leg Frame

Leg Cap Black Urethane: No Upcharge
Leg Cap Option - Wood: **Add 120.00**
Leg Cap Option - Aluminum: **Add 189.00**

GC4131

| COM | 2 | 3 | 4 | 5 | 6 | 7 | 8 | 9 | 10 | 11 | 12 |
|--------|--------|--------|--------|--------|--------|--------|--------|--------|--------|--------|--------|
| \$1083 | \$1112 | \$1194 | \$1232 | \$1284 | \$1312 | \$1359 | \$1432 | \$1499 | \$1557 | \$1702 | \$1702 |

OVERALL DIMENSIONS SEAT DIMENSIONS BACK DIMENSIONS

| OVERALL DIMENSIONS | | | SEAT DIMENSIONS | | | BACK DIMENSIONS | |
|--------------------|----|----|-----------------|----|----|-----------------|---|
| W | D | H | W | D | H | W | H |
| 24.5 | 26 | 19 | 21.5 | -- | 19 | | |

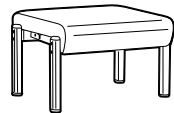

Bariatric Single Seat Bench

COM Yardage: 2.25
Freight Class: 250
Product Weight (lbs.): 48
Cubic Feet Per Carton: 12.25

Aluminum Leg Frame

Leg Cap Black Urethane: No Upcharge
Leg Cap Option - Wood: **Add 120.00**
Leg Cap Option - Aluminum: **Add 189.00**



- For users up to 750 lbs.

GC4142

| COM | 2 | 3 | 4 | 5 | 6 | 7 | 8 | 9 | 10 | 11 | 12 |
|--------|--------|--------|--------|--------|--------|--------|--------|--------|--------|--------|--------|
| \$1357 | \$1409 | \$1452 | \$1515 | \$1605 | \$1638 | \$1716 | \$1864 | \$1938 | \$2075 | \$2265 | \$2265 |

OVERALL DIMENSIONS SEAT DIMENSIONS BACK DIMENSIONS

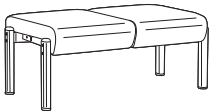
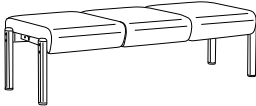
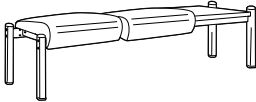
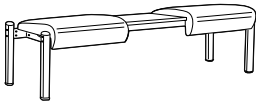
| OVERALL DIMENSIONS | | | SEAT DIMENSIONS | | | BACK DIMENSIONS | |
|--------------------|----|----|-----------------|----|----|-----------------|---|
| W | D | H | W | D | H | W | H |
| 34.5 | 26 | 19 | 31 | -- | 19 | | |

| DESCRIPTION | MODEL# | STANDARD FABRIC GRADES | | | | | | | | | | | |
|--|-----------|---------------------------|--------|--------|------------------------|--------|--------|------------------------|--------|--------|--------|--------|--------|
| | | COM | 2 | 3 | 4 | 5 | 6 | 7 | 8 | 9 | 10 | 11 | 12 |
|  <p>Two Seat Bench COM Yardage: 2.50 Freight Class: 250 Product Weight (lbs.): 65 Cubic Feet Per Carton: 23</p> | GC4132 | \$1447 | \$1505 | \$1552 | \$1623 | \$1722 | \$1760 | \$1847 | \$2010 | \$2092 | \$2244 | \$2456 | \$2456 |
| | | OVERALL DIMENSIONS | | | SEAT DIMENSIONS | | | BACK DIMENSIONS | | | | | |
| | | W | D | H | W | D | H | W | H | | | | |
| <p>Aluminum Leg Frame Leg Cap Black Urethane: No Upcharge Leg Cap Option - Wood: Add 120.00 Leg Cap Option - Aluminum: Add 189.00</p> | | 46 | 26 | 19 | 43 | -- | 19 | | | | | | |
|  <p>Three Seat Bench COM Yardage: 3.75 Freight Class: 250 Product Weight (lbs.): 90 Cubic Feet Per Carton: 33.25</p> | GC4133 | \$2455 | \$2542 | \$2613 | \$2718 | \$2867 | \$2924 | \$3054 | \$3300 | \$3422 | \$3651 | \$3968 | \$3968 |
| | | OVERALL DIMENSIONS | | | SEAT DIMENSIONS | | | BACK DIMENSIONS | | | | | |
| | | W | D | H | W | D | H | W | H | | | | |
| <p>Aluminum Leg Frame Leg Cap Black Urethane: No Upcharge Leg Cap Option - Wood: Add 120.00 Leg Cap Option - Aluminum: Add 189.00</p> | | 67.5 | 26 | 19 | 64.5 | -- | 19 | | | | | | |
|  <p>Two Seat Bench with Left Square Tablet COM Yardage: 2.50 Freight Class: 250 Product Weight (lbs.): 97 Cubic Feet Per Carton: 33.25</p> | GC41340T | \$2385 | \$2443 | \$2490 | \$2561 | \$2660 | \$2698 | \$2785 | \$2948 | \$3030 | \$3182 | \$3394 | \$3394 |
| | | OVERALL DIMENSIONS | | | SEAT DIMENSIONS | | | BACK DIMENSIONS | | | | | |
| | | W | D | H | W | D | H | W | H | | | | |
| <p>Aluminum Leg Frame Leg Cap Black Urethane: No Upcharge Leg Cap Option - Wood: Add 120.00 Leg Cap Option - Aluminum: Add 189.00</p> <ul style="list-style-type: none"> High pressure laminate tablet is available in a variety of finishes | | 67.5 | 26 | 19 | 21.5 | -- | 19 | | | | | | |
|  <p>Two Seat Bench with Center Square Tablet COM Yardage: 2.50 Freight Class: 250 Product Weight (lbs.): 97 Cubic Feet Per Carton: 33.25</p> | GC4134CT | \$2385 | \$2443 | \$2490 | \$2561 | \$2660 | \$2698 | \$2785 | \$2948 | \$3030 | \$3182 | \$3394 | \$3394 |
| | | OVERALL DIMENSIONS | | | SEAT DIMENSIONS | | | BACK DIMENSIONS | | | | | |
| | | W | D | H | W | D | H | W | H | | | | |
| <p>Aluminum Leg Frame Leg Cap Black Urethane: No Upcharge Leg Cap Option - Wood: Add 120.00 Leg Cap Option - Aluminum: Add 189.00</p> <ul style="list-style-type: none"> High pressure laminate tablet is available in a variety of finishes | | 67.5 | 26 | 19 | 21.5 | -- | 19 | | | | | | |
|  <p>Single Seat Bench Top COM Yardage: 1.50 Freight Class: 100 Product Weight (lbs.): 28 Cubic Feet Per Carton: 2.90</p> | GC4131TOP | \$844 | \$873 | \$941 | \$979 | \$1031 | \$1060 | \$1107 | \$1179 | \$1246 | \$1304 | \$1448 | \$1448 |
| | | OVERALL DIMENSIONS | | | SEAT DIMENSIONS | | | BACK DIMENSIONS | | | | | |
| | | W | D | H | W | D | H | W | H | | | | |
| <p>Includes Perma-Mesh™ suspension with 2" steel interior frame. All hardware required for assembly of this unit is included.</p> | | 21.5 | 26 | 6.5 | | | | | | | | | |

| DESCRIPTION | MODEL# | STANDARD FABRIC GRADES | | | | | | | | | | | |
|-------------|--------|------------------------|---|---|---|---|---|---|---|---|----|----|----|
| | | COM | 2 | 3 | 4 | 5 | 6 | 7 | 8 | 9 | 10 | 11 | 12 |



Two Seat Bench Top
 COM Yardage: 2.50
 Freight Class: 125
 Product Weight (lbs.): 55
 Cubic Feet Per Carton: 7.50

Includes Perma-Mesh™ suspension with 2" steel interior frame.
 All hardware required for assembly of this unit is included.

| OVERALL DIMENSIONS | | | SEAT DIMENSIONS | | | BACK DIMENSIONS | |
|--------------------|---|---|-----------------|---|---|-----------------|---|
| W | D | H | W | D | H | W | H |

43 26 6.5

| DESCRIPTION | MODEL# | STANDARD FABRIC GRADES | | | | | | | | | | | |
|-------------|--------|------------------------|---|---|---|---|---|---|---|---|----|----|----|
| | | COM | 2 | 3 | 4 | 5 | 6 | 7 | 8 | 9 | 10 | 11 | 12 |



Three Seat Bench Top
 COM Yardage: 3.75
 Freight Class: 125
 Product Weight (lbs.): 78
 Cubic Feet Per Carton: 11.25

Includes Perma-Mesh™ suspension with 2" steel interior frame.
 All hardware required for assembly of this unit is included.

| OVERALL DIMENSIONS | | | SEAT DIMENSIONS | | | BACK DIMENSIONS | |
|--------------------|---|---|-----------------|---|---|-----------------|---|
| W | D | H | W | D | H | W | H |

64.5 26 6.5

| DESCRIPTION | MODEL# | STANDARD FABRIC GRADES | | | | | | | | | | | |
|-------------|--------|------------------------|---|---|---|---|---|---|---|---|----|----|----|
| | | COM | 2 | 3 | 4 | 5 | 6 | 7 | 8 | 9 | 10 | 11 | 12 |



Seat Cushion
 COM Yardage: 1.50
 Freight Class: 250
 Product Weight (lbs.): 8
 Cubic Feet Per Carton: 2.90

For Bench units.
 Velcro fasteners for attachment to seat frame are standard.
 • Frame not included. Must be ordered separately.

| OVERALL DIMENSIONS | | | SEAT DIMENSIONS | | | BACK DIMENSIONS | |
|--------------------|---|---|-----------------|---|---|-----------------|---|
| W | D | H | W | D | H | W | H |

21.5 26 6.5

| | | | | | |
|---------------------------|-----------------|----|----|-----|--------------|
| GC4131S1 (single seat) | 21 x 19.5 x 2.5 | 65 | 21 | .80 | \$630 |
|---------------------------|-----------------|----|----|-----|--------------|



Seat Frame

For benches. Mounting hardware for all 4 sides are included. Tungsten finish.
 • Seat cushion(s) not included. Must be ordered separately.

| | | | | | |
|--------------------------|-----------------|----|----|------|---------------|
| GC4133S3 (three seat) | 64 x 19.5 x 2.5 | 65 | 55 | 2.40 | \$1054 |
|--------------------------|-----------------|----|----|------|---------------|

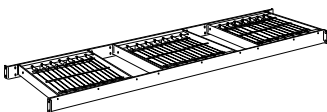

Seat Frame

For benches. Mounting hardware for all 4 sides are included. Tungsten finish.
 • Seat cushion(s) not included. Must be ordered separately.

- Tables can be mounted to seating or bench units to create a unique configuration.
- Square and rectangular shaped occasional tables offer the added convenience of a magazine rack.
- All tables are shipped Knock Down (KD), complete with the bolts and the plates attached to the legs.
- A Fully Assembled Shipping option is available. Please contact your GlobalCare Sales Representative for a special quotation.
- Tops are 1" thick and available in thermally fused laminate (LP) or high pressure laminate. Please select the appropriate model number for the finish you prefer.
- 3mm edging color coordinated with laminate finish is standard for all tops. Finish **MUST BE** specified at the time of order.
- For custom laminate or contrasting edge, please contact your Global sales representative for special quotation.

Thermally Fused Laminate (L)

- (ACJ) Absolute Acajou
- (ASN) Asian Night
- (AWC) Avant Cherry
- (AWH) Avant Honey
- (BRC) Brushed Cobalt
- (CSJ) Constellation Java
- (DES) Dark Espresso
- (HGT) Hayden Grey
- (QTM) Quartered Mahogany
- (SKC) Shaker Cherry
- (TFW) Tiger Fruitwood
- (TMA) Tiger Mahogany
- (TMP) Tiger Maple
- (TWL) Tiger Walnut
- (WHT) White
- (WHC) White Chocolate
- (WCR) Winter Cherry

High Pressure Laminate (H)

- (W357) Avant Cherry
- (W356) Avant Honey
- (BCH) Brushed Cobalt
- (CJH) Constellation Java
- (W142) Dark Espresso
- (W313) Quartered Mahogany
- (SKB) Shaker Cherry
- (W821) Tiger Fruitwood
- (W822) Tiger Mahogany
- (W820) Tiger Maple
- (W819) Tiger Walnut
- (S645) White
- (W149) Winter Cherry

- (CMB) Clear Maple
- (EMB) Empire Mahogany



ALUMINUM Frame Leg Insert Options

- Aluminum leg frames are available in Platinum (**PLT**), Toast (**TOA**), Tungsten (**TUN**), Cappuccino (**T20**), Mocha (**J52**) and Kalua (**KAL**). Please Specify.
- **Leg Cap:** The **Half-Leg** option is available in the following finishes:
 - **Standard** - Urethane Ribbed Leg Insert - Available in Black (**BK**) Only.
 - **Aluminum** - Ribbed Leg Inserts are available in - Silver (**AU**), Champagne (**CP**) and Bronze (**LB**).
Non-Ribbed Leg Inserts are available in - Silver (**PS**), Platinum (**PLT**), Toast (**TOA**), Cappuccino (**T20**), Mocha (**J52**) and Kalua (**KAL**).
See individual models for specific upcharge. MUST Specify Ribbed or Non-Ribbed when ordering.
 - **Wood** - Available in the following finishes: **Add \$120.00.**
Absolute (AAM), Brandy Peppercorn (BPM), Charcoal Java (CJM), Cherry (ACM), Cherry Latte (CLM), Cocoa Vanilla (CVM), Empire Mahogany (EMM), English Oak (EOM), Espresso Cafe (ECM), Fruitwood (TFM), Gray (HGM), Harvest Oak (HOM), Honey (AHM), Jet Onyx (JOM), Light Honey (LHM), Mahogany (TMM), Maple (AVM), Medium Walnut (MWM), Night (ASM), Sandy Beach (SBM), Shaker Cherry (SKM), Silver Oak (SOM), Walnut (TWM), White (WHM), WC Cream (WTM) and Winter Cherry (WCM).
Maple faced veneers and solids are used for all finishes.

LEG CAPS

Standard

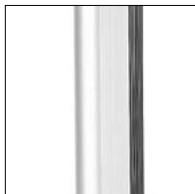

Black (ribbed), PVC front leg cap

Option

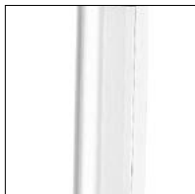

Aluminum (ribbed or non-ribbed)
- Silver only, front leg cap

Option

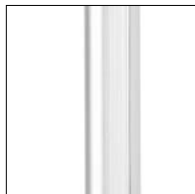

Wood front leg cap

Suggested Applications

- Waiting Areas
- Lobbies



Square End Table - Aluminum Legs
23" Square

| MODEL# | DIMENSIONS | FREIGHT CLASS | WT/LBS. | CUBIC FT. | LIST PRICE |
|------------|--------------|---------------|---------|-----------|--------------|
| GC4103S | 23 x 23 x 16 | 125 | 25 | 3.40 | \$823 |
| GC4103S-LP | 23 x 23 x 16 | 125 | 23 | 3.40 | \$792 |

- For a thermally fused top (LP), specify model GC4103S-LP.
- For a high pressure laminate top, specify model GC4103S.

- Coordinating 3 mm edge.
- Leg Cap Black Urethane: No Upcharge
 - Leg Cap Option - Wood: **Add 120.00**
 - Leg Cap Option - Aluminum: **Add 189.00**



Square End Table - Aluminum Legs
21" Square

| | | | | | |
|------------|--------------|-----|----|------|--------------|
| GC4104S | 21 x 21 x 16 | 125 | 24 | 3.40 | \$823 |
| GC4104S-LP | 21 x 21 x 16 | 125 | 22 | 3.40 | \$792 |

- For a thermally fused top (LP), specify model GC4104S-LP.
- For a high pressure laminate top, specify model GC4104S.

- Coordinating 3 mm edge.
- Leg Cap Black Urethane: No Upcharge
 - Leg Cap Option - Wood: **Add 120.00**
 - Leg Cap Option - Aluminum: **Add 189.00**

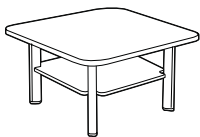

Square End Table w/Magazine Shelf
Aluminum Legs, 23" Square

| | | | | | |
|--------------|--------------|------|----|------|--------------|
| GC4103SMR | 23 x 23 x 16 | 92.5 | 34 | 3.40 | \$991 |
| GC4103SMR-LP | 23 x 23 x 16 | 100 | 32 | 3.40 | \$975 |

- For a thermally fused top (LP), specify model GC4103SMR-LP.
- For a high pressure laminate top, specify model GC4103SMR.

- Coordinating 3 mm edge.
- Leg Cap Black Urethane: No Upcharge
 - Leg Cap Option - Wood: **Add 120.00**
 - Leg Cap Option - Aluminum: **Add 189.00**

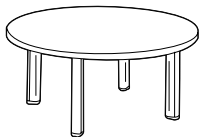

Round Coffee Table - Aluminum Legs

| | | | | | |
|------------|--------------|-----|----|---|--------------|
| GC4108C | 36 x 36 x 16 | 125 | 37 | 6 | \$831 |
| GC4108C-LP | 36 x 36 x 16 | 150 | 34 | 6 | \$770 |

- For a thermally fused top (LP), specify model GC4108C-LP.
- For a high pressure laminate top, specify model GC4108C.

- Coordinating 3 mm edge.
- Leg Cap Black Urethane: No Upcharge
 - Leg Cap Option - Wood: **Add 120.00**
 - Leg Cap Option - Aluminum: **Add 189.00**

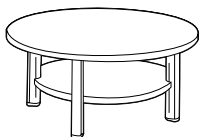

Round Coffee Table w/Magazine Shelf
Aluminum Legs

| | | | | | |
|--------------|--------------|-----|----|---|---------------|
| GC4108CMR | 36 x 36 x 16 | 100 | 57 | 6 | \$1292 |
| GC4108CMR-LP | 36 x 36 x 16 | 100 | 54 | 6 | \$1168 |

- For a thermally fused top (LP), specify model GC4108CMR-LP.
- For a high pressure laminate top, specify model GC4108CMR.

- Coordinating 3 mm edge.
- Leg Cap Black Urethane: No Upcharge
 - Leg Cap Option - Wood: **Add 120.00**
 - Leg Cap Option - Aluminum: **Add 189.00**

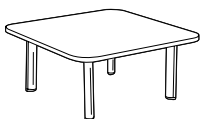

Square Coffee Table - Aluminum Legs

| | | | | | |
|------------|--------------|-----|----|---|--------------|
| GC4108S | 36 x 36 x 16 | 125 | 43 | 6 | \$831 |
| GC4108S-LP | 36 x 36 x 16 | 125 | 40 | 6 | \$770 |

- For a thermally fused top (LP), specify model GC4108S-LP.
- For a high pressure laminate top, specify model GC4108S.

- Coordinating 3 mm edge.
- Leg Cap Black Urethane: No Upcharge
 - Leg Cap Option - Wood: **Add 120.00**
 - Leg Cap Option - Aluminum: **Add 189.00**

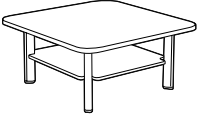
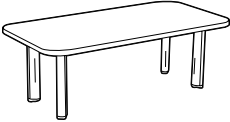
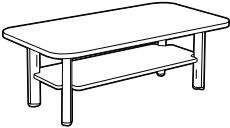
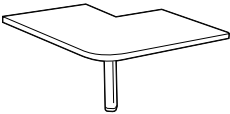
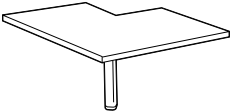
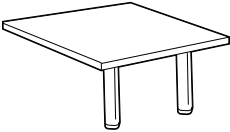
| | MODEL# | DIMENSIONS | FREIGHT CLASS | WT./LBS. | CUBIC FT. | LIST PRICE |
|---|--------------|---|---------------|----------|-----------|---------------|
|  <p>Square Coffee Table w/Magazine Shelf Aluminum Legs</p> | GC4108SMR | 36 x 36 x 16 | 92.5 | 63 | 6 | \$1292 |
| | GC4108SMR-LP | 36 x 36 x 16 | 92.5 | 60 | 6 | \$1168 |
| | | <ul style="list-style-type: none"> • For a thermally fused top (LP), specify model GC4108SMR-LP. • For a high pressure laminate top, specify model GC4108SMR. | | | | |
| | | <p>Coordinating 3 mm edge.</p> <ul style="list-style-type: none"> • Leg Cap Black Urethane: No Upcharge • Leg Cap Option - Wood: Add 120.00 • Leg Cap Option - Aluminum: Add 189.00 | | | | |
|  <p>Rectangular Coffee Table Aluminum Legs</p> | GC4109R | 24 x 48 x 16 | 125 | 39 | 5.75 | \$831 |
| | GC4109R-LP | 24 x 48 x 16 | 125 | 36 | 5.75 | \$782 |
| | | <ul style="list-style-type: none"> • For a thermally fused top (LP), specify model GC4109R-LP. • For a high pressure laminate top, specify model GC4109R. | | | | |
| | | <p>Coordinating 3 mm edge.</p> <ul style="list-style-type: none"> • Leg Cap Black Urethane: No Upcharge • Leg Cap Option - Wood: Add 120.00 • Leg Cap Option - Aluminum: Add 189.00 | | | | |
|  <p>Rectangular Coffee Table w/Magazine Shelf - Aluminum Legs</p> | GC4109RMR | 24 x 48 x 16 | 100 | 53 | 5.75 | \$1292 |
| | GC4109RMR-LP | 24 x 48 x 16 | 100 | 50 | 5.75 | \$1222 |
| | | <ul style="list-style-type: none"> • For a thermally fused top (LP), specify model GC4109RMR-LP. • For a high pressure laminate top, specify model GC4109RMR. | | | | |
| | | <p>Coordinating 3 mm edge.</p> <ul style="list-style-type: none"> • Leg Cap Black Urethane: No Upcharge • Leg Cap Option - Wood: Add 120.00 • Leg Cap Option - Aluminum: Add 189.00 | | | | |
|  <p>90° Corner Table - Aluminum Leg, Radius</p> | GC4100RC | 35 x 35 x 16 | 125 | 45 | 6 | \$746 |
| | GC4100RC-LP | 35 x 35 x 16 | 125 | 45 | 6 | \$684 |
| | | <ul style="list-style-type: none"> • For a thermally fused top (LP), specify model GC4100RC-LP. • For a high pressure laminate top, specify model GC4100RC. | | | | |
| | | <p>Coordinating 3 mm edge. Mounting hardware for all 4 sides is included. Allows for knee space when specifying chairs in a corner position. (Must be connected to full height or lower half frame unit.)</p> <ul style="list-style-type: none"> • Leg Cap Black Urethane: No Upcharge • Leg Cap Option - Wood: Add 33.00 • Leg Cap Option - Aluminum: Add 51.00 | | | | |
|  <p>90° Corner Table - Aluminum Leg, Square</p> | GC4100SC | 35 x 35 x 16 | 125 | 45 | 6 | \$746 |
| | GC4100SC-LP | 35 x 35 x 16 | 125 | 45 | 6 | \$684 |
| | | <ul style="list-style-type: none"> • For a thermally fused top (LP), specify model GC4100SC-LP. • For a high pressure laminate top, specify model GC4100SC. | | | | |
| | | <p>Coordinating 3 mm edge. Mounting hardware for all 4 sides is included. Allows for knee space when specifying chairs in a corner position. (Must be connected to full height or lower half frame unit.)</p> <ul style="list-style-type: none"> • Leg Cap Black Urethane: No Upcharge • Leg Cap Option - Wood: Add 33.00 • Leg Cap Option - Aluminum: Add 51.00 | | | | |
|  <p>End Run Table - Aluminum Legs</p> | GC4100SE | 23 x 23 x 16 | 150 | 17 | 3.40 | \$588 |
| | GC4100SE-LP | 23 x 23 x 16 | 150 | 17 | 3.40 | \$582 |
| | | <ul style="list-style-type: none"> • For a thermally fused top (LP), specify model GC4100SE-LP. • For a high pressure laminate top, specify model GC4100SE. | | | | |
| | | <p>Coordinating 3 mm edge. Mounting hardware for all 4 sides is included. (Must be connected to full height or lower half frame unit.)</p> <ul style="list-style-type: none"> • Leg Cap Black Urethane: No Upcharge • Leg Cap Option - Wood: Add 61.00 • Leg Cap Option - Aluminum: Add 97.00 | | | | |

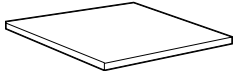
| TABLE COMPONENT PARTS | MODEL# | DIMENSIONS | FREIGHT CLASS | WT/LBS. | CUBIC FT. | LIST PRICE |
|---|--------------|-------------|---------------|---------|-----------|--------------|
|  | GC4100SET | 23 x 23 x 1 | 150 | 15 | 3.40 | \$377 |
| | GC4100SET-LP | 23 x 23 x 1 | 150 | 15 | 3.40 | \$353 |

- For a thermally fused top (LP), specify model GC4100SET-LP.
- For a high pressure laminate top, specify model GC4100SET.

Square Table Top

Coordinating 3 mm edge. Mounting hardware for all 4 sides is included. (Must be connected to full height or lower half frame unit on each side.)

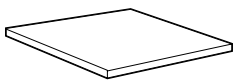
| | | | | | | |
|---|-------------|-------------|-----|----|------|--------------|
|  | GC4104ST | 21 x 21 x 1 | 150 | 14 | 3.40 | \$377 |
| | GC4104ST-LP | 21 x 21 x 1 | 150 | 14 | 3.40 | \$353 |

- For a thermally fused top (LP), specify model GC4104ST-LP.
- For a high pressure laminate top, specify model GC4104ST.

Square Table Top

Replaces seat position within one piece frame. Coordinating 3 mm edge. Mounting hardware for all 4 sides is included.

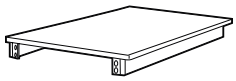
| | | | | | | |
|---|--------------|-------------|-----|----|------|--------------|
|  | GC4104WST | 21 x 21 x 1 | 150 | 18 | 3.40 | \$453 |
| | GC4104WST-LP | 21 x 21 x 1 | 150 | 18 | 3.40 | \$430 |

- For a thermally fused top (LP), specify model GC4104WST-LP.
- For a high pressure laminate top, specify model GC4104WST.

Square Table Top with Skirt

Replaces seat position within one piece frame. Coordinating 3 mm edge. Mounting hardware for all 4 sides is included.

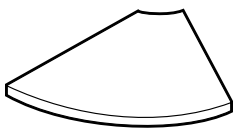
| | | | | | | |
|--|-------------|-------------|-----|----|------|--------------|
|  | GC4134AT | 23 x 24 x 1 | 250 | 12 | 3.40 | \$399 |
| | GC4134AT-LP | 23 x 24 x 1 | 250 | 12 | 3.40 | \$393 |

- For a thermally fused top (LP), specify model GC4134AT-LP.
- For a high pressure laminate top, specify model GC4134AT.

45° Table Top

Coordinating 3 mm edge. Mounting hardware for all 4 sides is included. (Must be connected to full height or lower half frame unit on both sides of the top.) Can not be suspended between 2 frames with no lower leg frame.

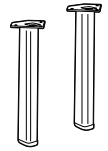
| | | | | | | |
|---|----------|------------|------|------|-----|--------------|
|  | GC4100SL | 4 x 4 x 15 | 92.5 | 3.50 | .30 | \$127 |
|---|----------|------------|------|------|-----|--------------|

Half Leg - Aluminum

For Tables. Aluminum leg with Black front half leg cap. Mounting plate and hardware. Per unit.

- Leg Cap Black Urethane: No Upcharge
- Leg Cap Option - Wood: **Add 33.00**
- Leg Cap Option - Aluminum: **Add 51.00**

JANNA





model GC7609

STANDARD FEATURES

- Features a folding frame that is ideal for temporary seating and unexpected guests.
- In folded form, Janna models require 7" depth for storage.
- Optional wall bracket (model GC7607) allows chairs to be conveniently stored while not in use. (Underside of chair seat is predrilled to accept wall bracket.)
- Wood frame is available in a variety of finishes. **Available in Maple Wood Only.**
- For Globalcare textiles and wood finish options, visit the web site at www.thinkglobalcare.com.
- This product can be upholstered in standard Global textiles only if Healthcare compliance is not required.
- This product is shipped fully assembled.
- Non-marking nylon glides are standard. Optional cushion glide is available - **Add \$9.00** list upcharge.
- Seat is made from Ultracell foam for added comfort. Moisture Barrier (Seat Only) - **Add \$85.00** list upcharge.
- For addition of a Fire Barrier Lining - **Add \$65.00** list upcharge per yard.
- Call Customer Service for **CAL133** approved textiles.

SUGGESTED APPLICATIONS

- Patient Rooms
- Guest Seating
- Exam Rooms
- Resident Rooms
- Waiting Areas
- Dining Rooms

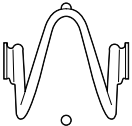
| DESCRIPTION | MODEL# | STANDARD FABRIC GRADES | | | | | | | | | | | |
|---|--------|------------------------|-------|-------|-----------------|-------|-------|-----------------|-------|-------|-------|-------|-------|
| | | COM | 2 | 3 | 4 | 5 | 6 | 7 | 8 | 9 | 10 | 11 | 12 |
|  <p>Folding Chair Upholstered Back COM Yardage: 1 Freight Class: 150 Product Weight (lbs.): 19 Cubic Feet Per Carton: 3.50</p> | GC7609 | \$448 | \$471 | \$490 | \$518 | \$558 | \$573 | \$608 | \$673 | \$706 | \$767 | \$852 | \$852 |
| | | OVERALL DIMENSIONS | | | SEAT DIMENSIONS | | | BACK DIMENSIONS | | | | | |
| | | W | D | H | W | D | H | W | H | | | | |
| | | 19 | 22.5 | 32.5 | 16 | 17.5 | 18.5 | 16 | 13.5 | | | | |
|  <p>Folding Chair Wood Back COM Yardage: 1 Freight Class: 150 Product Weight (lbs.): 19 Cubic Feet Per Carton: 3.50</p> | GC7611 | \$532 | \$555 | \$574 | \$602 | \$642 | \$657 | \$692 | \$757 | \$790 | \$851 | \$936 | \$936 |
| | | OVERALL DIMENSIONS | | | SEAT DIMENSIONS | | | BACK DIMENSIONS | | | | | |
| | | W | D | H | W | D | H | W | H | | | | |
| | | 19 | 22.5 | 32.5 | 16 | 17.5 | 18.5 | 16 | 13.5 | | | | |
|  <p>Wall Mounting Bracket. For Janna series only. Allows for hanging a chair on the wall or behind a door. COM Yardage: -- Freight Class: 70 Product Weight (lbs.): 1.50 Cubic Feet Per Carton: .10</p> | GC7607 | List Price | | | | | | | | | | | |
| | | \$41 | | | | | | | | | | | |
| | | OVERALL DIMENSIONS | | | SEAT DIMENSIONS | | | BACK DIMENSIONS | | | | | |
| | | W | D | H | W | D | H | W | H | | | | |
| | | | 3 | 1.5 | 3.5 | | | | | | | | |

If ordering after the original purchase, specify GC7607.

For complete set at time of order - specify WH. Add \$42

Two (one pair) per package in chrome finish. One bracket connects to the underside of the chair seat. The second bracket connects to the wall or door.

KENSINGTON



model GC4160

STANDARD FEATURES

- A creative wood design enhances the picture frame style back.
- Contoured arms with a firm grip extension assist users in the entry and exit from the chair.
- Strength and stability are increased with the use of an 'H' brace in the frame.
- For Globalcare textiles and wood finish options, visit the web site at www.thinkglobalcare.com. **Available in European Beech Wood Only (Refer to finishes that end with an "M").**
- This product is shipped fully assembled.

- Standard glide is plastic. For Non-slip glides specify (NS) - **Add \$21.00** list upcharge.
- Seat is made from Ultracell foam for added comfort. Moisture Barrier (Seat Only) - **Add \$85.00** list upcharge.
- For addition of a Fire Barrier Lining - **Add \$65.00** list upcharge per yard.
- Call Customer Service for **CAL133** approved textiles.

SUGGESTED APPLICATIONS

- Dining Rooms

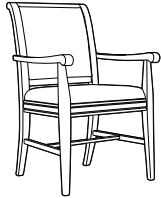

GC4160

| COM | 2 | 3 | 4 | 5 | 6 | 7 | 8 | 9 | 10 | 11 | 12 |
|--------|--------|--------|--------|--------|--------|--------|--------|--------|--------|--------|--------|
| \$1228 | \$1256 | \$1343 | \$1377 | \$1426 | \$1446 | \$1490 | \$1571 | \$1612 | \$1687 | \$1794 | \$1794 |

| OVERALL DIMENSIONS | | | SEAT DIMENSIONS | | | BACK DIMENSIONS | |
|--------------------|------|----|-----------------|----|------|-----------------|------|
| W | D | H | W | D | H | W | H |
| 22.5 | 23.5 | 37 | 20 | 17 | 18.5 | 19.5 | 18.5 |

Armchair
 COM Yardage: 1.25
 Freight Class: 300
 Product Weight (lbs.): 26
 Cubic Feet Per Carton: 14.50

MAJESTY



model GC3776

STANDARD FEATURES

- Traditional styling and details combined with modern healthcare function.
- Open sealed frame below cushions and raised front panel for cleaning access.
- Wood frame and legs in a variety of finishes. **Available in Maple wood Only.**
- For Globalcare textiles and wood finish options, visit the web site at www.thinkglobalcare.com.
- This product can be upholstered in standard Global textiles only if Healthcare compliance is not required.
- This product is shipped fully assembled.

- Standard glide is plastic. For Non-slip glides specify (NS) - **Add \$21.00** list upcharge.
- Seat is made from Ultracell foam for added comfort. Moisture Barrier (Seat Only) - **Add \$85.00** list upcharge.
- For addition of a Fire Barrier Lining - **Add \$65.00** list upcharge per yard.
- Call Customer Service for **CAL133** approved textiles.

SUGGESTED APPLICATIONS

- Waiting Areas
- Dining Rooms
- Resident Rooms
- Lounges
- Lobbies
- Guest Seating

| DESCRIPTION | MODEL# | STANDARD FABRIC GRADES | | | | | | | | | | | |
|---|-------------------------------------|---------------------------|---------------|---------------|------------------------|---------------|---------------|------------------------|---------------|---------------|---------------|---------------|---------------|
| | | COM | 2 | 3 | 4 | 5 | 6 | 7 | 8 | 9 | 10 | 11 | 12 |
|  | GC3776 | \$1003 | \$1054 | \$1152 | \$1221 | \$1319 | \$1356 | \$1442 | \$1600 | \$1681 | \$1830 | \$2037 | \$2037 |
| | GC3776-20 20" seat height | \$1442 | \$1493 | \$1614 | \$1683 | \$1780 | \$1817 | \$1902 | \$2062 | \$2143 | \$2292 | \$2498 | \$2498 |
| | | OVERALL DIMENSIONS | | | SEAT DIMENSIONS | | | BACK DIMENSIONS | | | | | |
| | | W | D | H | W | D | H | W | H | | | | |
| | | 25.5 | 25.5 | 37.5 | 20.5 | 17 | 18 | 20.5 | 19 | | | | |
| | | 25.5 | 25.5 | 39.5 | 20.5 | 17 | 20 | 20.5 | 19 | | | | |

High Back Armchair Wood Arms
COM Yardage: 2.50
Freight Class: 300
Product Weight (lbs.): 28
Cubic Feet Per Carton: 20.25

Loose seat cushion.

| DESCRIPTION | MODEL# | STANDARD FABRIC GRADES | | | | | | | | | | | |
|--|-------------------------------------|---------------------------|---------------|---------------|------------------------|---------------|---------------|------------------------|---------------|---------------|---------------|---------------|---------------|
| | | COM | 2 | 3 | 4 | 5 | 6 | 7 | 8 | 9 | 10 | 11 | 12 |
|  | GC3777 | \$902 | \$954 | \$1048 | \$1118 | \$1215 | \$1250 | \$1336 | \$1496 | \$1576 | \$1725 | \$1931 | \$1931 |
| | GC3777-20 20" seat height | \$1309 | \$1359 | \$1475 | \$1544 | \$1641 | \$1678 | \$1763 | \$1923 | \$2003 | \$2153 | \$2360 | \$2360 |
| | | OVERALL DIMENSIONS | | | SEAT DIMENSIONS | | | BACK DIMENSIONS | | | | | |
| | | W | D | H | W | D | H | W | H | | | | |
| | | 25.5 | 25.5 | 34 | 20.5 | 17 | 18 | 20.5 | 15 | | | | |
| | | 25.5 | 25.5 | 36 | 20.5 | 17 | 20 | 20.5 | 15 | | | | |

Low Back Armchair Wood Arms
COM Yardage: 2.50
Freight Class: 300
Product Weight (lbs.): 28
Cubic Feet Per Carton: 15.50

Loose seat cushion.

| DESCRIPTION | MODEL# | STANDARD FABRIC GRADES | | | | | | | | | | | |
|---|-------------------------------------|---------------------------|---------------|---------------|------------------------|---------------|---------------|------------------------|---------------|---------------|---------------|---------------|---------------|
| | | COM | 2 | 3 | 4 | 5 | 6 | 7 | 8 | 9 | 10 | 11 | 12 |
|  | GC3785 | \$961 | \$1019 | \$1066 | \$1137 | \$1236 | \$1274 | \$1361 | \$1524 | \$1606 | \$1758 | \$1970 | \$1970 |
| | GC3785-20 20" seat height | \$1089 | \$1147 | \$1194 | \$1265 | \$1364 | \$1402 | \$1489 | \$1652 | \$1734 | \$1886 | \$2098 | \$2098 |
| | | OVERALL DIMENSIONS | | | SEAT DIMENSIONS | | | BACK DIMENSIONS | | | | | |
| | | W | D | H | W | D | H | W | H | | | | |
| | | 26 | 25 | 38 | 20.5 | 17 | 18 | 20.5 | 20 | | | | |
| | | 26 | 25 | 40 | 20.5 | 17 | 20 | 20.5 | 20 | | | | |

High Back Armchair Upholstered Arms
COM Yardage: 2.50
Freight Class: 300
Product Weight (lbs.): 32
Cubic Feet Per Carton: 20.25

Loose seat cushion.

| DESCRIPTION | MODEL# | STANDARD FABRIC GRADES | | | | | | | | | | | |
|---|-------------------------------------|---------------------------|---------------|---------------|------------------------|---------------|---------------|------------------------|---------------|---------------|---------------|---------------|---------------|
| | | COM | 2 | 3 | 4 | 5 | 6 | 7 | 8 | 9 | 10 | 11 | 12 |
|  | GC3786 | \$887 | \$939 | \$982 | \$1045 | \$1134 | \$1168 | \$1246 | \$1394 | \$1468 | \$1604 | \$1795 | \$1795 |
| | GC3786-20 20" seat height | \$983 | \$1035 | \$1078 | \$1141 | \$1230 | \$1264 | \$1342 | \$1490 | \$1564 | \$1700 | \$1891 | \$1891 |
| | | OVERALL DIMENSIONS | | | SEAT DIMENSIONS | | | BACK DIMENSIONS | | | | | |
| | | W | D | H | W | D | H | W | H | | | | |
| | | 26 | 25 | 32.5 | 20.5 | 17 | 18 | 20.5 | 15 | | | | |
| | | 26 | 25 | 34.5 | 20.5 | 17 | 20 | 20.5 | 15 | | | | |

Low Back Armchair Upholstered Arms
COM Yardage: 2.25
Freight Class: 300
Product Weight (lbs.): 27
Cubic Feet Per Carton: 2.25

Loose seat cushion.

NOURISH



model GC3683F



model GC3685



Headrest adjustment handle



Casters and height adjustable legs



Transfer arm



FEATURES

- Nourish is an innovative state of the art patient chair, developed in consultation with leading Healthcare professionals. It embraces the body, cultivating comfort during periods of recovery. Housekeeping and infection control will appreciate the hassle-free maintenance and clean design.
- All chair models have a pair of **transfer arms** that are very easy to operate. Transfer arms increase ease of access for those less mobile users who need transfer to or from a wheelchair, while substantially fostering caregiver safety when patient assistance is required.
- Height adjustable legs** are standard on all models (except Bariatric chair, ottoman and GC3698 - 4 caster model). Legs can be conveniently adapted to provide patients with a seat height range of 17" to 20" for maximum fit. Additional models (-20) provide a seat height range of 20" to 23" ensuring the perfect seating solution is available for multiple applications. Front and back legs can be adjusted separately allowing modification of seat pitch, forward or rearward.
- Models with **rear casters** allow for 'tip and move' so the chair can be conveniently and easily repositioned without lifting.
- Easy grip Push Bar** is optional on Nourish patient chairs to assist in ease of movement of the chair. Available for all height adjustable leg models in Toast (TOA), Platinum (PLT), Tungsten (TUN), Cappuccino (T20), Mocha (J52), Kalua (KAL) and Black (BLK). Please specify - **Add \$99.00** list upcharge.
- On selected models, a unique **depth adjustable headrest** solution is integrated into the upper back area, preventing any possible loss or misplacement of the headrest and making cleaning and disinfecting easier. The Schukra depth adjustment is placed under the upholstery in the neck region. The depth is controlled by a handle on the lower outer back cushion. The ability to set the intensity of the headrest promotes a healthier, more personal level of comfort during the convalescence period.

- Schukra Depth adjustable lumbar support** for additional comfort is standard on selected models.
- Metal frame is available in Black (BLK), Platinum (PLT), Toast (TOA), Tungsten (TUN), Cappuccino (T20), Mocha (J52), and Kalua (KAL). Please specify.
- Self-skinned urethane armcaps are available in Black (BLK), Platinum (PLT), Toast (TOA), Cappuccino (T20), Mocha (J52), and Kalua (KAL). Please Specify.
- Arm body is standard in Tungsten only. No other colors are available.
- All seats are standard with High Density Ultracell foam.
- As an option, seams can be sealed to prevent penetration of fluids through the stitching. For High Back models - **Add \$104.00** list upcharge. For Bariatric models - **Add \$122.00** list upcharge. For Ottoman - **Add \$122.00** list upcharge. Contact CustomerCare for approved textiles.
- Moisture Barrier (Seat Only) - **Add \$85.00** list upcharge per seat. For Bariatric models - **Add \$122.00** list upcharge per seat.
- Active weight capacity for standard single seat is 350 lbs. and 750 lbs for Bariatric Seating.
- For addition of a Fire Barrier Lining - **Add \$65.00** list upcharge per yard.
- For Globalcare textile options, visit the web site at www.thinkglobalcare.com.
- This product can be upholstered in standard Global textiles only if Healthcare compliance is not required.
- Call Customer Care for **CAL133** approved textiles.

SUGGESTED APPLICATIONS

- Patient Rooms
- Resident Rooms
- Exam Rooms

| DESCRIPTION | MODEL# | STANDARD FABRIC GRADES | | | | | | | | | | | | | | | | | | | | | | | | | | | | | | | |
|---|---|------------------------|--------------------|--------|--------|-----------------|--------|--------|-----------------|--------|--------|--------|--------|---|---|---|---|---|------|----|------|----|------|-------|----|----|------|----|------|----|------|-------|----|
| | | COM | 2 | 3 | 4 | 5 | 6 | 7 | 8 | 9 | 10 | 11 | 12 | | | | | | | | | | | | | | | | | | | | |
|  <p>High Back Patient Chair COM Yardage: 2 Freight Class: 300 Product Weight (lbs.): 56 Cubic Feet Per Carton: 33.50</p> | GC3681 | \$1786 | \$1832 | \$1870 | \$1926 | \$2006 | \$2036 | \$2105 | \$2237 | \$2302 | \$2424 | \$2593 | \$2593 | | | | | | | | | | | | | | | | | | | | |
| | GC3681-20 20" seat height | \$1828 | \$1874 | \$1912 | \$1968 | \$2048 | \$2078 | \$2148 | \$2279 | \$2344 | \$2466 | \$2635 | \$2635 | | | | | | | | | | | | | | | | | | | | |
| | <table border="1"> <thead> <tr> <th colspan="3">OVERALL DIMENSIONS</th> <th colspan="3">SEAT DIMENSIONS</th> <th colspan="2">BACK DIMENSIONS</th> </tr> <tr> <th>W</th> <th>D</th> <th>H</th> <th>W</th> <th>D</th> <th>H</th> <th>W</th> <th>H</th> </tr> </thead> <tbody> <tr> <td>28.5</td> <td>29</td> <td>45.5</td> <td>20</td> <td>18.5</td> <td>17-20</td> <td>20</td> <td>29</td> </tr> <tr> <td>28.5</td> <td>29</td> <td>48.5</td> <td>20</td> <td>18.5</td> <td>20-23</td> <td>20</td> <td>29</td> </tr> </tbody> </table> | | OVERALL DIMENSIONS | | | SEAT DIMENSIONS | | | BACK DIMENSIONS | | W | D | H | W | D | H | W | H | 28.5 | 29 | 45.5 | 20 | 18.5 | 17-20 | 20 | 29 | 28.5 | 29 | 48.5 | 20 | 18.5 | 20-23 | 20 |
| OVERALL DIMENSIONS | | | SEAT DIMENSIONS | | | BACK DIMENSIONS | | | | | | | | | | | | | | | | | | | | | | | | | | | |
| W | D | H | W | D | H | W | H | | | | | | | | | | | | | | | | | | | | | | | | | | |
| 28.5 | 29 | 45.5 | 20 | 18.5 | 17-20 | 20 | 29 | | | | | | | | | | | | | | | | | | | | | | | | | | |
| 28.5 | 29 | 48.5 | 20 | 18.5 | 20-23 | 20 | 29 | | | | | | | | | | | | | | | | | | | | | | | | | | |
|  <p>High Back Patient Chair with Schukra depth adjustable lumbar COM Yardage: 2 Freight Class: 300 Product Weight (lbs.): 56 Cubic Feet Per Carton: 33.50</p> | GC3682 | \$1893 | \$1939 | \$1977 | \$2033 | \$2112 | \$2143 | \$2212 | \$2343 | \$2408 | \$2530 | \$2700 | \$2700 | | | | | | | | | | | | | | | | | | | | |
| | GC3682-20 20" seat height | \$1935 | \$1981 | \$2018 | \$2075 | \$2154 | \$2185 | \$2255 | \$2385 | \$2451 | \$2572 | \$2742 | \$2742 | | | | | | | | | | | | | | | | | | | | |
| | <table border="1"> <thead> <tr> <th colspan="3">OVERALL DIMENSIONS</th> <th colspan="3">SEAT DIMENSIONS</th> <th colspan="2">BACK DIMENSIONS</th> </tr> <tr> <th>W</th> <th>D</th> <th>H</th> <th>W</th> <th>D</th> <th>H</th> <th>W</th> <th>H</th> </tr> </thead> <tbody> <tr> <td>28.5</td> <td>29</td> <td>45.5</td> <td>20</td> <td>18.5</td> <td>17-20</td> <td>20</td> <td>29</td> </tr> <tr> <td>28.5</td> <td>29</td> <td>48.5</td> <td>20</td> <td>18.5</td> <td>20-23</td> <td>20</td> <td>29</td> </tr> </tbody> </table> | | OVERALL DIMENSIONS | | | SEAT DIMENSIONS | | | BACK DIMENSIONS | | W | D | H | W | D | H | W | H | 28.5 | 29 | 45.5 | 20 | 18.5 | 17-20 | 20 | 29 | 28.5 | 29 | 48.5 | 20 | 18.5 | 20-23 | 20 |
| OVERALL DIMENSIONS | | | SEAT DIMENSIONS | | | BACK DIMENSIONS | | | | | | | | | | | | | | | | | | | | | | | | | | | |
| W | D | H | W | D | H | W | H | | | | | | | | | | | | | | | | | | | | | | | | | | |
| 28.5 | 29 | 45.5 | 20 | 18.5 | 17-20 | 20 | 29 | | | | | | | | | | | | | | | | | | | | | | | | | | |
| 28.5 | 29 | 48.5 | 20 | 18.5 | 20-23 | 20 | 29 | | | | | | | | | | | | | | | | | | | | | | | | | | |

| DESCRIPTION | MODEL# | STANDARD FABRIC GRADES | | | | | | | | | | | | | | | | | | | | | | | | | | | | | | | | | |
|---|---|------------------------|-----------------|--------------------|--------|-----------------|-----------------|--------|--------|-----------------|--------|--------|--------|---|---|---|---|---|---|---|------|----|------|----|------|-------|----|----|------|----|------|----|------|-------|----|
| | | COM | 2 | 3 | 4 | 5 | 6 | 7 | 8 | 9 | 10 | 11 | 12 | | | | | | | | | | | | | | | | | | | | | | |
|  <p>High Back Patient Chair with Schukra depth adjustable headrest COM Yardage: 2 Freight Class: 300 Product Weight (lbs.): 56 Cubic Feet Per Carton: 33.50</p> | GC3683 | \$2000 | \$2046 | \$2084 | \$2140 | \$2219 | \$2249 | \$2319 | \$2450 | \$2516 | \$2637 | \$2806 | \$2806 | | | | | | | | | | | | | | | | | | | | | | |
| | GC3683-20 20" seat height | \$2041 | \$2087 | \$2125 | \$2181 | \$2261 | \$2291 | \$2361 | \$2492 | \$2558 | \$2679 | \$2848 | \$2848 | | | | | | | | | | | | | | | | | | | | | | |
| | <table border="1"> <thead> <tr> <th colspan="3">OVERALL DIMENSIONS</th> <th colspan="3">SEAT DIMENSIONS</th> <th colspan="3">BACK DIMENSIONS</th> </tr> <tr> <th>W</th> <th>D</th> <th>H</th> <th>W</th> <th>D</th> <th>H</th> <th>W</th> <th>H</th> </tr> </thead> <tbody> <tr> <td>28.5</td> <td>29</td> <td>45.5</td> <td>20</td> <td>18.5</td> <td>17-20</td> <td>20</td> <td>29</td> </tr> <tr> <td>28.5</td> <td>29</td> <td>48.5</td> <td>20</td> <td>18.5</td> <td>20-23</td> <td>20</td> <td>29</td> </tr> </tbody> </table> | | | OVERALL DIMENSIONS | | | SEAT DIMENSIONS | | | BACK DIMENSIONS | | | W | D | H | W | D | H | W | H | 28.5 | 29 | 45.5 | 20 | 18.5 | 17-20 | 20 | 29 | 28.5 | 29 | 48.5 | 20 | 18.5 | 20-23 | 20 |
| OVERALL DIMENSIONS | | | SEAT DIMENSIONS | | | BACK DIMENSIONS | | | | | | | | | | | | | | | | | | | | | | | | | | | | | |
| W | D | H | W | D | H | W | H | | | | | | | | | | | | | | | | | | | | | | | | | | | | |
| 28.5 | 29 | 45.5 | 20 | 18.5 | 17-20 | 20 | 29 | | | | | | | | | | | | | | | | | | | | | | | | | | | | |
| 28.5 | 29 | 48.5 | 20 | 18.5 | 20-23 | 20 | 29 | | | | | | | | | | | | | | | | | | | | | | | | | | | | |

|  <p>High Back Patient Chair with Schukra depth adjustable lumbar & headrest COM Yardage: 2 Freight Class: 300 Product Weight (lbs.): 56 Cubic Feet Per Carton: 33.50</p> | GC3684 | \$2213 | \$2259 | \$2297 | \$2353 | \$2432 | \$2463 | \$2533 | \$2663 | \$2729 | \$2850 | \$3020 | \$3020 | | | | | | | | | | | | | | | | | | | | | | |
|--|---|--------|-----------------|--------------------|--------|-----------------|-----------------|--------|--------|-----------------|--------|--------|--------|---|---|---|---|---|---|---|------|----|------|----|------|-------|----|----|------|----|------|----|------|-------|----|
| | GC3684-20 20" seat height | \$2254 | \$2299 | \$2337 | \$2394 | \$2473 | \$2503 | \$2573 | \$2704 | \$2770 | \$2891 | \$3060 | \$3060 | | | | | | | | | | | | | | | | | | | | | | |
| | <table border="1"> <thead> <tr> <th colspan="3">OVERALL DIMENSIONS</th> <th colspan="3">SEAT DIMENSIONS</th> <th colspan="3">BACK DIMENSIONS</th> </tr> <tr> <th>W</th> <th>D</th> <th>H</th> <th>W</th> <th>D</th> <th>H</th> <th>W</th> <th>H</th> </tr> </thead> <tbody> <tr> <td>28.5</td> <td>29</td> <td>45.5</td> <td>20</td> <td>18.5</td> <td>17-20</td> <td>20</td> <td>29</td> </tr> <tr> <td>28.5</td> <td>29</td> <td>48.5</td> <td>20</td> <td>18.5</td> <td>20-23</td> <td>20</td> <td>29</td> </tr> </tbody> </table> | | | OVERALL DIMENSIONS | | | SEAT DIMENSIONS | | | BACK DIMENSIONS | | | W | D | H | W | D | H | W | H | 28.5 | 29 | 45.5 | 20 | 18.5 | 17-20 | 20 | 29 | 28.5 | 29 | 48.5 | 20 | 18.5 | 20-23 | 20 |
| OVERALL DIMENSIONS | | | SEAT DIMENSIONS | | | BACK DIMENSIONS | | | | | | | | | | | | | | | | | | | | | | | | | | | | | |
| W | D | H | W | D | H | W | H | | | | | | | | | | | | | | | | | | | | | | | | | | | | |
| 28.5 | 29 | 45.5 | 20 | 18.5 | 17-20 | 20 | 29 | | | | | | | | | | | | | | | | | | | | | | | | | | | | |
| 28.5 | 29 | 48.5 | 20 | 18.5 | 20-23 | 20 | 29 | | | | | | | | | | | | | | | | | | | | | | | | | | | | |

|  <p>Bariatric High Back Patient Chair COM Yardage: 3.25 Freight Class: 300 Product Weight (lbs.): 70 Cubic Feet Per Carton: 45</p> | GC3685 | \$2195 | \$2270 | \$2332 | \$2423 | \$2552 | \$2600 | \$2714 | \$2926 | \$3033 | \$3232 | \$3505 | \$3505 | | | | | | | | | | | | | | |
|---|--|--------|-----------------|--------------------|--------|-----------------|-----------------|--------|--------|-----------------|--------|--------|--------|---|---|---|---|---|---|---|----|----|----|----|------|------|----|
| | Fixed height legs. • For users up to 750 lbs. | | | | | | | | | | | | | | | | | | | | | | | | | | |
| | <table border="1"> <thead> <tr> <th colspan="3">OVERALL DIMENSIONS</th> <th colspan="3">SEAT DIMENSIONS</th> <th colspan="3">BACK DIMENSIONS</th> </tr> <tr> <th>W</th> <th>D</th> <th>H</th> <th>W</th> <th>D</th> <th>H</th> <th>W</th> <th>H</th> </tr> </thead> <tbody> <tr> <td>40</td> <td>29</td> <td>47</td> <td>35</td> <td>18.5</td> <td>18.5</td> <td>35</td> <td>29</td> </tr> </tbody> </table> | | | OVERALL DIMENSIONS | | | SEAT DIMENSIONS | | | BACK DIMENSIONS | | | W | D | H | W | D | H | W | H | 40 | 29 | 47 | 35 | 18.5 | 18.5 | 35 |
| OVERALL DIMENSIONS | | | SEAT DIMENSIONS | | | BACK DIMENSIONS | | | | | | | | | | | | | | | | | | | | | |
| W | D | H | W | D | H | W | H | | | | | | | | | | | | | | | | | | | | |
| 40 | 29 | 47 | 35 | 18.5 | 18.5 | 35 | 29 | | | | | | | | | | | | | | | | | | | | |

|  <p>Ottoman COM Yardage: 1 Freight Class: 150 Product Weight (lbs.): 18 Cubic Feet Per Carton: 3.60</p> | GC3686 | \$548 | \$571 | \$590 | \$618 | \$658 | \$673 | \$708 | \$774 | \$806 | \$867 | \$951 | \$951 | | | | | | | | | | | | | | |
|---|--|-------|-----------------|--------------------|-------|-----------------|-----------------|-------|-------|-----------------|-------|-------|-------|---|---|---|---|---|---|---|----|------|------|--|--|--|--|
| | Can be stored beneath any Nourish chair when not in use. | | | | | | | | | | | | | | | | | | | | | | | | | | |
| | <table border="1"> <thead> <tr> <th colspan="3">OVERALL DIMENSIONS</th> <th colspan="3">SEAT DIMENSIONS</th> <th colspan="3">BACK DIMENSIONS</th> </tr> <tr> <th>W</th> <th>D</th> <th>H</th> <th>W</th> <th>D</th> <th>H</th> <th>W</th> <th>H</th> </tr> </thead> <tbody> <tr> <td>17</td> <td>17.5</td> <td>12.5</td> <td></td> <td></td> <td></td> <td></td> <td></td> </tr> </tbody> </table> | | | OVERALL DIMENSIONS | | | SEAT DIMENSIONS | | | BACK DIMENSIONS | | | W | D | H | W | D | H | W | H | 17 | 17.5 | 12.5 | | | | |
| OVERALL DIMENSIONS | | | SEAT DIMENSIONS | | | BACK DIMENSIONS | | | | | | | | | | | | | | | | | | | | | |
| W | D | H | W | D | H | W | H | | | | | | | | | | | | | | | | | | | | |
| 17 | 17.5 | 12.5 | | | | | | | | | | | | | | | | | | | | | | | | | |

DESCRIPTION MODEL# STANDARD FABRIC GRADES

OTTOMANS



model GC3346

STANDARD FEATURES

- Designed to coordinate with GLOBALcare seating series.
- Seat cushions are easily removable for cleaning.
- Wood legs are available in a variety of finishes. **Available in Maple wood Only.**
- A steel leg is optionally available on GC3646. Offered in Black (BLK), Platinum (PLT), Toast (TOA), Tungsten (TUN), Cappuccino (T20), Mocha (J52), and Kalua (KAL). Please specify.
- For a complete list of Globalcare textiles and wood seating finishes, visit the web site at www.thinkglobalcare.com.

- Standard glide is plastic.
- For hardwood legs, non-slip glides specify (NS) - **Add \$21.00** list upcharge.
- For hardwood legs, opaque, non-marking glide is optional for hard surface flooring. No upcharge.
- This product is shipped fully assembled.
- This product can be upholstered in standard Global textiles only if Healthcare compliance is not required.

SUGGESTED APPLICATIONS

- Waiting Areas
- Resident Rooms
- Lounges

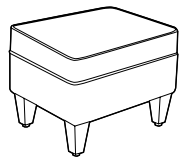

Ottoman Block Legs
COM Yardage: 1.25
Freight Class: 150
Product Weight (lbs.): 20
Cubic Feet Per Carton: 4.60

GC3346

| COM | 2 | 3 | 4 | 5 | 6 | 7 | 8 | 9 | 10 | 11 | 12 |
|-------|-------|-------|--------|--------|--------|--------|--------|--------|--------|--------|--------|
| \$933 | \$962 | \$986 | \$1021 | \$1071 | \$1090 | \$1133 | \$1215 | \$1256 | \$1332 | \$1438 | \$1438 |

| OVERALL DIMENSIONS | | | SEAT DIMENSIONS | | | BACK DIMENSIONS | |
|--------------------|------|----|-----------------|----|----|-----------------|---|
| W | D | H | W | D | H | W | H |
| 19.5 | 17.5 | 15 | -- | -- | 15 | | |

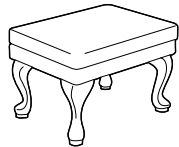

Ottoman Queen Anne Legs
COM Yardage: 1
Freight Class: 250
Product Weight (lbs.): 16
Cubic Feet Per Carton: 5.25

Legs are available in Maple wood only.

GC7536

| COM | 2 | 3 | 4 | 5 | 6 | 7 | 8 | 9 | 10 | 11 | 12 |
|-------|-------|-------|-------|-------|-------|-------|-------|-------|-------|-------|-------|
| \$473 | \$493 | \$538 | \$565 | \$603 | \$618 | \$652 | \$715 | \$749 | \$807 | \$890 | \$890 |

| OVERALL DIMENSIONS | | | SEAT DIMENSIONS | | | BACK DIMENSIONS | |
|--------------------|----|----|-----------------|----|----|-----------------|---|
| W | D | H | W | D | H | W | H |
| 21 | 16 | 15 | -- | -- | 15 | | |

DESCRIPTION

MODEL#

STANDARD FABRIC GRADES

PEMBROOKE



model GC3789

STANDARD FEATURES

- Attractive wood frame with a unique picture frame style back.
- Strength and stability are increased with the use of an 'H' brace in the frame.
- For Globalcare textiles and wood finish options, visit the web site at www.thinkglobalcare.com.

Available in Maple wood Only.

- This product is shipped fully assembled.
- Front Casters available on model ending with **FC**.
- Standard glide is plastic. For Non-slip glides specify (NS) - **Add \$21.00** list upcharge.

- High density Ultracell foam. Moisture Barrier (Seat Only) - **Add \$109.00** list upcharge.
- For addition of a Fire Barrier Lining - **Add \$65.00** list upcharge per yard.
- Call Customer Service for **CAL133** approved textiles.

SUGGESTED APPLICATIONS

- Dining Rooms
- Guest Seating
- Waiting Areas
- Resident Rooms

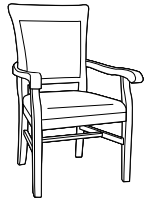

GC3789

| COM | 2 | 3 | 4 | 5 | 6 | 7 | 8 | 9 | 10 | 11 | 12 |
|--------|--------|--------|--------|--------|--------|--------|--------|--------|--------|--------|--------|
| \$1635 | \$1660 | \$1768 | \$1800 | \$1850 | \$1868 | \$1910 | \$1992 | \$2031 | \$2104 | \$2210 | \$2210 |

| OVERALL DIMENSIONS | | | SEAT DIMENSIONS | | | BACK DIMENSIONS | |
|--------------------|----|----|-----------------|------|----|-----------------|----|
| W | D | H | W | D | H | W | H |
| 24.5 | 24 | 39 | 20 | 17.5 | 18 | 17 | 22 |

Armchair

COM Yardage: 1.25
 Freight Class: 300
 Product Weight (lbs.): 34
 Cubic Feet Per Carton: 17.25

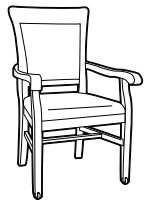

GC3789FC

| COM | 2 | 3 | 4 | 5 | 6 | 7 | 8 | 9 | 10 | 11 | 12 |
|--------|--------|--------|--------|--------|--------|--------|--------|--------|--------|--------|--------|
| \$1747 | \$1775 | \$1890 | \$1926 | \$1979 | \$1997 | \$2045 | \$2129 | \$2173 | \$2252 | \$2363 | \$2363 |

| OVERALL DIMENSIONS | | | SEAT DIMENSIONS | | | BACK DIMENSIONS | |
|--------------------|----|----|-----------------|------|----|-----------------|----|
| W | D | H | W | D | H | W | H |
| 24.5 | 24 | 39 | 20 | 17.5 | 18 | 17 | 22 |

Armchair Front Casters

COM Yardage: 1.25
 Freight Class: 300
 Product Weight (lbs.): 34
 Cubic Feet Per Carton: 17.25

DESCRIPTION MODEL# STANDARD FABRIC GRADES

PHOENIX



model GC4164

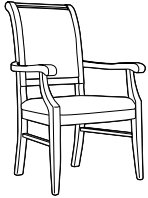

GC4164

STANDARD FEATURES

- Unique elements such as a rolled wood top rail.
- Armrests feature an accentuated curve with a firm grip extension to assist users in the entry and exit from the chair.
- Additional leg support bars complement the leg frame and ensure strength and durability.
- For Globalcare textiles and wood finish options, visit the web site at www.thinkglobalcare.com.
Available in European Beech Wood Only (Refer to finishes that end with an "M").
- This product is shipped fully assembled.
- Standard glide is plastic. For Non-slip glides specify (NS) - **Add \$21.00** list upcharge.
- High density Ultracell foam. Moisture Barrier (Seat Only) - **Add \$85.00** list upcharge.
- For addition of a Fire Barrier Lining - **Add \$65.00** list upcharge per yard.
- Call Customer Service for **CAL133** approved textiles.

SUGGESTED APPLICATIONS

- Dining Rooms

| COM | 2 | 3 | 4 | 5 | 6 | 7 | 8 | 9 | 10 | 11 | 12 |
|--------|--------|--------|--------|--------|--------|--------|--------|--------|--------|--------|--------|
| \$1221 | \$1248 | \$1335 | \$1370 | \$1420 | \$1439 | \$1482 | \$1564 | \$1605 | \$1680 | \$1786 | \$1786 |

| OVERALL DIMENSIONS | | | SEAT DIMENSIONS | | | BACK DIMENSIONS | |
|--------------------|------|------|-----------------|------|----|-----------------|----|
| W | D | H | W | D | H | W | H |
| 25 | 26.5 | 40.5 | 21.5 | 18.5 | 18 | 17.5 | 23 |

Armchair
 COM Yardage: 1.25
 Freight Class: 300
 Product Weight (lbs.): 30
 Cubic Feet Per Carton: 20

DESCRIPTION

MODEL#

STANDARD FABRIC GRADES



GC3616W Dining Armchair with open arms

Primacare™ is a new benchmark in healthcare seating. All the features, all the looks and quite possibly the most extensive offering of its kind for both acute care and long term care applications. As the name implies, Primacare is a first for both care givers and specifiers.

Under the skin of every Primacare chair is a heart of solid steel waiting to meet the rigorous demands of any environment. The Primacare series includes more than 40 models that extend from patient rooms to waiting areas, dining rooms to treatment centers and bariatric applications.

NEW | PRODUCT

FEATURES



Open Arms.



Closed Arms - fully upholstered side panels.



Arm Grip Extension - to assist getting in and out of the chair safely.

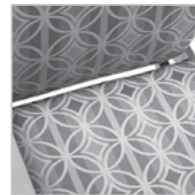

Separate Seat and Back - provides clean out for housekeeping staff.



Removable Headrest - to provide access for care giver assistance.



Removable Upholstery - for ease of cleaning and replacement.



Solid Wood Frame - in hardwood for long life and a warm look.



Metal to Metal Connector - provides unparalleled strength and durability.

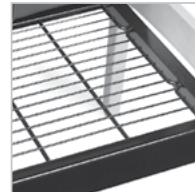

Metal Mesh Pan - superior comfort and hygiene for patient incontinence.



Wall Safe Legs - offer first contact to protect walls and chair back.

AVAILABLE TEXTILES & FINISHES

• Available in an extensive range of GLOBALcare Crypton and Vinyl upholstery fabrics. Please see the Textile and Finishes section at www.thinkglobalcare.com for all details including wood finishes.

SUGGESTED APPLICATIONS

- Patient Rooms and Treatment Areas
- Dining Rooms, Family and Common rooms
- Lounge, Reception and Waiting Areas
- Recovery, Maternity and Intensive Care

GUEST

LOW BACK SINGLE SEATER
GC3620W Open arms
GC3620WCA Closed arms
GC3620WF Flex back, Open arms
GC3620WFCA Flex back, Closed arms

LOW BACK BARIATRIC
GC3637W Open arms
GC3637WCA Closed arms

LOW BACK TWO SEATER
GC3621W Outside open arms
GC3621WCA Closed arms

LOW BACK THREE SEATER
GC3624W Outside open arms
GC3624WCA Closed arms

LOW BACK TWO SEATER
Half arm in the middle
GC3623W Outside open arms
GC3623WCA Closed arms

LOW BACK THREE SEATER
Half arms in the middle
GC3626W Outside open arms
GC3626WCA Closed arms

LOW BACK TWO SEATER
Full arm in the middle
GC3622W Outside open arms
GC3622WCA Closed arms

LOW BACK THREE SEATER
Full arms in the middle
GC3625W Outside open arms
GC3625WCA Closed arms

LOW BACK FOUR SEATER
Full arms in the middle
GC3628W Outside open arms
GC3628WCA Closed arms

LOW BACK FIVE SEATER
Full arms in the middle
GC3630W Outside open arms
GC3630WCA Closed arms

DINING

ARMCHAIR
GC3616W Open arms
GC3616WCA Closed arms

PATIENT

MID BACK
GC3631W Open arms
GC3631WCA Closed arms
GC3631WF Flex back, Open arms
GC3631WFCA Flex back, Closed arms

MID BACK BARIATRIC
GC3638W Open arms
GC3638WCA Closed arms

HIGH BACK
GC3655W Open arms
GC3655WCA Closed arms
GC3655WF Flex back, Open arms
GC3655WFCA Flex back, Closed arms

HIGH BACK BARIATRIC
GC3656W Open arms
GC3656WCA Closed arms

HIGH BACK with fold-away headrest
GC3632W Open arms
GC3632WCA Closed arms
GC3632WF Flex back, Open arms
GC3632WFCA Flex back, Closed arms

HIGH BACK BARIATRIC with fold-away headrest
GC3639W Open arms
GC3639WCA Closed arms

LOUNGE

SINGLE SEATER
GC3641W Open arms
GC3641WCA Closed arms

BARIATRIC
GC3640W Open arms
GC3640WCA Closed arms

TWO SEATER
GC3642W Open arms
GC3642WCA Closed arms

THREE SEATER
GC3643W Open arms
GC3643WCA Closed arms

SLEEPERS AND RECLINERS



SLEEPER
GC3610

DOUBLE SLEEPER
GC3612

WIDE BODY SLEEPER
GC3611

RECLINER
GC3605 Full wood arms
GC3606 Partial wood arms

MOTION RECLINER
GC3608 Full wood arms
GC3609 Partial wood arms

| GUEST | DINING |
|---|---|
|  <p>LOW BACK SINGLE SEATER GC3620 Open arms GC3620CA Closed arms GC3620F Flex back, Open arms GC3620FCA Flex back, Closed arms GC3620RC Rear Wheels, Open arms GC3620CARC Rear Wheels, Closed arms</p> <p>LOW BACK BARIATRIC GC3637 Open arms GC3637CA Closed arms</p> |  <p>ARMCHAIR GC3616 Open arms GC3616CA Closed arms</p> |
| <p>LOW BACK TWO SEATER GC3621 Outside open arms GC3621CA Closed arms</p> <p>LOW BACK THREE SEATER GC3624 Outside open arms GC3624CA Closed arms</p> <p>LOW BACK TWO SEATER Half arm in the middle GC3623 Outside open arms GC3623CA Closed arms</p> <p>LOW BACK THREE SEATER Half arms in the middle GC3626 Outside open arms GC3626CA Closed arms</p> <p>LOW BACK TWO SEATER Full arm in the middle GC3622 Outside open arms GC3622CA Closed arms</p> <p>LOW BACK THREE SEATER Full arms in the middle GC3625 Outside open arms GC3625CA Closed arms</p> <p>LOW BACK FOUR SEATER Full arms in the middle GC3628 Outside open arms GC3628CA Closed arms</p> <p>LOW BACK FIVE SEATER Full arms in the middle GC3630 Outside open arms GC3630CA Closed arms</p> | <p>MID BACK GC3631 Open arms GC3631CA Closed arms GC3631F Flex Back, Open arms GC3631FCA Flex Back, Closed arms GC3631RC Rear Wheels, Open arms GC3631CARC Rear Wheels, Closed arms</p> <p>MID BACK BARIATRIC GC3638 Open arms GC3638CA Closed arms</p> <p>HIGH BACK GC3655 Open arms GC3655CA Closed arms GC3655F Flex Back, Open arms GC3655FCA Flex Back, Closed arms GC3655RC Rear Wheels, Open arms GC3655CARC Rear Wheels, Closed arms</p> <p>HIGH BACK BARIATRIC GC3656 Open arms GC3656CA Closed arms</p> <p>HIGH BACK with fold-away headrest GC3632 Open arms GC3632CA Closed arms GC3632F Flex Back, Open arms GC3632FCA Flex Back, Closed arms GC3632RC Rear Wheels, Open arms GC3632CARC Rear Wheels, Closed arms</p> <p>HIGH BACK BARIATRIC with fold-away headrest GC3639 Open arms GC3639CA Closed arms</p> |
| LOUNGE | |
|  <p>SINGLE SEATER GC3641 Open arms GC3641CA Closed arms</p> <p>BARIATRIC GC3640 Open arms GC3640CA Closed arms</p> <p>TWO SEATER GC3642 Open arms GC3642CA Closed arms</p> <p>THREE SEATER GC3643 Open arms GC3643CA Closed arms</p> | |

PRIMACARE COLLECTION

FEATURES



model GC3620W



model GC3641W



model GC3605



model GC3610

- This collection adds a uniform look to any facility by offering over 40 versatile models.
- Single to five seater styles with or without arms ensure a perfect configuration, no matter the size of the space.
- **Solid hardwood frame** with die cast zinc connectors and metal to metal fastening. Available in the following finishes: Absolute (AAM), Brandy Peppercorn (BPM), Charcoal Java (CJM), Cherry (ACM), Cherry Latte (CLM), Cocoa Vanilla (CVM), Empire Mahogany (EMM), English Oak (EOM), Espresso Cafe (ECM), Fruitwood (TFM), Gray (HGM), Harvest Oak (HOM), Honey (AHM), Jet Onyx (JOM), Light Honey (LHM), Mahogany (TMM), Maple (AVM), Medium Walnut (MWM), Night (ASM), Sandy Beach (SBM), Shaker Cherry (SKM), Silver Oak (SOM), Walnut (TWM), White (WHM), WC Cream (WTM) and Winter Cherry (WCM).
- Dining, Guest, Patient and Lounge units include metal mesh seat deck.
- Contoured back with built-in lumbar support provides comfort and support.
- 350 lb. weight capacity for entire collection. Motion Recliners support 400lbs. Bariatric models support up to 500 lbs.
- Wallsaver legs offer first contact to protect walls and chair back. *Not available on Recliners.*
- Replaceable seat covers and replaceable and/or removable seat cushions.
- Easy grip forward extending armcap on models with arms.
- Anti-microbial and Anti-bacterial additive in top coat of wood finish.
- Waterfall cleanout between the seat and back cushions on all models.
- Wood armcaps and wood legs are available in a variety of finishes.
- Optional self-skinned urethane armcaps are available on select models in Black (BK), Toast (TOA), Platinum (PLT), Tungsten (TUN), Cappuccino (T20), Mocha (J52), and Kalua (KAL) at an upcharge. *Refer to individual models for availability and pricing.*
- Armcaps are securely fastened with metal to metal connectors which allow for field replacement if required.
- Seat and back are made from 3.5" Ultracell bio foam for added comfort.
- High density Ultracell foam is standard. **Moisture Barrier (Seat Only) - Add \$85.00** list upcharge per seat.
- For Bariatric Models: GC3637W, GC3637WCA, GC3638W, GC3638WCA, GC3639W, GC3639WCA, GC3640W, GC3640WCA, GC3656W and GC3656WCA - **Add \$131.00** list upcharge per seat.
- For Lounge Models: GC3641W, GC3641WCA, GC3642W, GC3642WCA, GC3643W and GC3643WCA - **Add \$127.00** list upcharge per seat.
- For Sleepers and Recliners - **Add \$127.00** list upcharge per seat.
- For Globalcare textiles and wood finish options, visit the web site at www.thinkglobalcare.com.
- This product can be upholstered in standard Global textiles if healthcare compliance is not required.
- All WCA models have closed upholstered arm cover at each arm position.

- This product shipped fully assembled, unless otherwise noted
- For addition of a fire barrier lining - **Add \$65.00** list upcharge per yard.
- Call Customer Care for **CAL133** approved textiles.
- All lounge seating is available with optional 3" higher seat back. Contact Customer Care for more information.
- Complementary tables are offered as part of this series in either high pressure or thermally fused laminate tops. Available in all Globalcare standard laminates.

RECLINERS & MOTION RECLINERS

- 3 position recliners
- Back, seat and leg platforms are slip covered so they can be easily removed for cleaning and replacement.
- Optional Black (BLK), Platinum (PLT), Toast (TOA), Cappuccino (T20), Mocha (J52), and Kalua (KAL) self-skinned urethane armcaps are available (models GC3605 and GC3608 Only) - **Add \$172.00** list upcharge. (Must be specified at time of order placement.)
- Shipped Semi-Knock Down (KD)
- The high back with built-in lumbar and three piece leg support benefit a user while in the seated or recline position

RECLINERS

(models GC3605, GC3606)

- Unique recline release handle is located below each armrest and is easy to use and reach.
- Back reclines to 60° angle maximum. Allow 11" wall clearance for full recline.
- Overall depth from back to front with foot recline extended is 50"
- Overall depth from back to front with foot recline extended and back at complete 60° recline is 70"
- Depth from seat front to end of foot recline extended is 17"

MOTION RECLINERS

(models GC3608, GC3609)

- Manual push back enables a user to easily adjust to the desired position. Allow 19" wall clearance for full recline.
- Overall depth from back to front with foot recline extended is 69½"
- Depth from the front of the seat to the extended leg rest is 18½"
- 400 lb. weight capacity
- Tablet arm (Right or/and Left hand) is optionally available. The tablet rotates so it can be positioned for any user activity and can fold down to store beside the chair when not being used. It is made of Phenolic material, which is an extremely dense polymer resin material. Although quite thin, the tablet is exceptionally strong. To order, please SPECIFY (LT) for left hand Tablet (from seated position) or (RT) for right hand tablet (from seated position) - **Add \$700.00** list upcharge.
- Mobility Option includes a Polished Chrome Rigid Push Bar Handle and Casters to aid in the movement of the chair. Specify (MRC) - no upcharge.
- Primacare Motion Recliner is not intended to be used as a Patient Transfer Chair

- Casters are non marring 4" medical grade wheel style casters. There are two 4" manual locking swivel casters on the front and two manual locking 4" non swivel casters on the back of the unit.

SLEEPERS

- Ideal for lounge and patient rooms where space is at a premium and additional sleeping accommodations may be needed.
- Hidden storage compartment for blankets and pillows uses Nylon runners sliding on welded heavy gauge steel channel to allow for easy movement when opening and closing.
- Zero wall clearance required for full extension, 77" open length
- Two coordinating textile covered Nylon straps are provided on the back to pull up and return the sleeping platform to a seating position.
- Optional Black (BLK), Platinum (PLT) and Toast (TOA), Cappuccino (T20), Mocha (J52), and Kalua (KAL) self-skinned urethane armcaps are available - **Add \$172.00** list upcharge. (Must be specified at time of order placement.)
- Armcaps are securely fastened with metal to metal connectors which allow for field replacement if required.
- Leg options are available with four wood tapered legs or manual locking casters

SUGGESTED APPLICATIONS

- Waiting Areas
- Dining Rooms
- Patient Rooms
- Lobbies
- Lounges
- Guest Seating
- Resident Rooms

| DESCRIPTION | MODEL# | STANDARD FABRIC GRADES | | | | | | | | | | | |
|---|--------|------------------------|--------|--------|-----------------|--------|--------|-----------------|--------|--------|--------|--------|--------|
| | | COM | 2 | 3 | 4 | 5 | 6 | 7 | 8 | 9 | 10 | 11 | 12 |
|  <p>Recliner Chair Solid Wood Armcaps, Full Span COM Yardage: 6.50 Freight Class: 150 Product Weight (lbs.): 110 Cubic Feet Per Carton: 22.75</p> <p>Head mat & loose seat cushion.</p> <p>SSU armcap option - Add \$172 list upcharge For users up to 350 lbs. • <i>Not available with casters</i></p> | GC3605 | \$2077 | \$2221 | \$2455 | \$2638 | \$2895 | \$2994 | \$3220 | \$3647 | \$3859 | \$4254 | \$4803 | \$4803 |
| | | OVERALL DIMENSIONS | | | SEAT DIMENSIONS | | | BACK DIMENSIONS | | | | | |
| | | W | D | H | W | D | H | W | H | | | | |
| | | 29.5 | 34.5 | 45.5 | 21.5 | 20 | 17 | 21.5 | 28 | | | | |

|  <p>Recliner Chair Solid Wood Armcaps, Front Only COM Yardage: 6.50 Freight Class: 150 Product Weight (lbs.): 110 Cubic Feet Per Carton: 22.75</p> <p>Head mat & loose seat cushion.</p> <p>For users up to 350 lbs. • <i>Not available with casters</i></p> | GC3606 | \$1969 | \$2113 | \$2341 | \$2524 | \$2782 | \$2881 | \$3106 | \$3532 | \$3746 | \$4141 | \$4690 | \$4690 |
|---|--------|--------------------|--------|--------|-----------------|--------|--------|-----------------|--------|--------|--------|--------|--------|
| | | OVERALL DIMENSIONS | | | SEAT DIMENSIONS | | | BACK DIMENSIONS | | | | | |
| | | W | D | H | W | D | H | W | H | | | | |
| | | 29.5 | 34.5 | 45.5 | 21.5 | 20 | 17 | 21.5 | 28 | | | | |

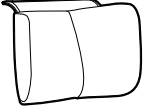
|  <p>Headrest for Primacare recliners COM Yardage: 1.25 Freight Class: 250 Product Weight (lbs.): 3 Cubic Feet Per Carton: 1</p> | GC3607 | \$83 | \$110 | \$141 | \$175 | \$225 | \$244 | \$288 | \$368 | \$410 | \$486 | \$591 | \$591 |
|---|--------|--------------------|-------|-------|-----------------|-------|-------|-----------------|-------|-------|-------|-------|-------|
| | | OVERALL DIMENSIONS | | | SEAT DIMENSIONS | | | BACK DIMENSIONS | | | | | |
| | | W | D | H | W | D | H | W | H | | | | |
| | | 14 | 4 | 9.5 | | | | | | | | | |

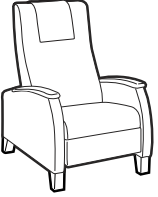
|  <p>Motion Recliner Chair Solid Wood Armcaps, Full Span COM Yardage: 6.50 Freight Class: 150 Product Weight (lbs.): 120 Cubic Feet Per Carton: 27.75</p> <p>SSU armcap option - Add \$172 list upcharge For users up to 400 lbs.</p> | GC3608 | \$2360 | \$2504 | \$2752 | \$2935 | \$3193 | \$3290 | \$3517 | \$3942 | \$4156 | \$4551 | \$5101 | \$5101 |
|--|--------|--------------------|--------|--------|-----------------|--------|--------|-----------------|--------|--------|--------|--------|--------|
| | | OVERALL DIMENSIONS | | | SEAT DIMENSIONS | | | BACK DIMENSIONS | | | | | |
| | | W | D | H | W | D | H | W | H | | | | |
| | | 30 | 39 | 46.5 | 23.5 | 20 | 19 | 22.5 | 29 | | | | |

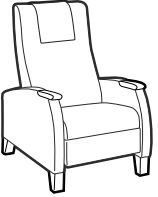
|  <p>Motion Recliner Chair Solid Wood Armcaps, Front Only COM Yardage: 6.50 Freight Class: 150 Product Weight (lbs.): 120 Cubic Feet Per Carton: 27.75</p> <p>For users up to 400 lbs.</p> | GC3609 | \$2254 | \$2398 | \$2640 | \$2823 | \$3081 | \$3178 | \$3405 | \$3830 | \$4045 | \$4440 | \$4989 | \$4989 |
|--|--------|--------------------|--------|--------|-----------------|--------|--------|-----------------|--------|--------|--------|--------|--------|
| | | OVERALL DIMENSIONS | | | SEAT DIMENSIONS | | | BACK DIMENSIONS | | | | | |
| | | W | D | H | W | D | H | W | H | | | | |
| | | 30 | 39 | 46.5 | 23.5 | 20 | 19 | 22.5 | 29 | | | | |

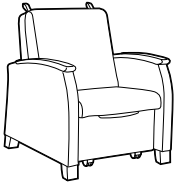
| DESCRIPTION | MODEL# | STANDARD FABRIC GRADES | | | | | | | | | | | |
|---|--------|------------------------------------|--------|--------|---------------------------------|--------|--------|-------------------------------|--------|--------|--------|--------|--------|
| | | COM | 2 | 3 | 4 | 5 | 6 | 7 | 8 | 9 | 10 | 11 | 12 |
|  <p>Lounge Chair/Sleeper Chair Single, Wood Legs COM Yardage: 7.50 Freight Class: 250 Product Weight (lbs.): 116 Cubic Feet Per Carton: 32.25</p> | GC3610 | \$2135 | \$2310 | \$2574 | \$2796 | \$3107 | \$3225 | \$3500 | \$4016 | \$4275 | \$4754 | \$5419 | \$5419 |
| | | OVERALL DIMENSIONS W D H | | | SEAT DIMENSIONS W D H | | | BACK DIMENSIONS W H | | | | | |
| | | 31.5 | 37.5 | 38 | 24 | 20 | 18 | 24 | 21 | | | | |

Sleep surface is 24.5"W x 77"L
SSU armcap option - **Add \$172 list upcharge**
For users up to 350 lbs.

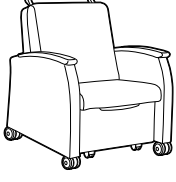
| DESCRIPTION | MODEL# | STANDARD FABRIC GRADES | | | | | | | | | | | |
|---|---------|------------------------------------|--------|--------|---------------------------------|--------|--------|-------------------------------|--------|--------|--------|--------|--------|
| | | COM | 2 | 3 | 4 | 5 | 6 | 7 | 8 | 9 | 10 | 11 | 12 |
|  <p>Lounge Chair/Sleeper Chair Single, Casters COM Yardage: 7.50 Freight Class: 250 Product Weight (lbs.): 116 Cubic Feet Per Carton: 32.25</p> | GC3610C | \$2135 | \$2310 | \$2574 | \$2796 | \$3107 | \$3225 | \$3500 | \$4016 | \$4275 | \$4754 | \$5419 | \$5419 |
| | | OVERALL DIMENSIONS W D H | | | SEAT DIMENSIONS W D H | | | BACK DIMENSIONS W H | | | | | |
| | | 31.5 | 37.5 | 38 | 24 | 20 | 18 | 24 | 21 | | | | |

Sleep surface is 24.5"W x 77"L
SSU armcap option - **Add \$172 list upcharge**
For users up to 350 lbs.

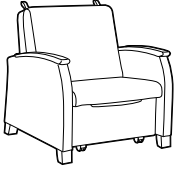
| DESCRIPTION | MODEL# | STANDARD FABRIC GRADES | | | | | | | | | | | |
|---|--------|------------------------------------|--------|--------|---------------------------------|--------|--------|-------------------------------|--------|--------|--------|--------|--------|
| | | COM | 2 | 3 | 4 | 5 | 6 | 7 | 8 | 9 | 10 | 11 | 12 |
|  <p>Lounge Chair/Sleeper Chair Single, Wide, Wood Legs COM Yardage: 9 Freight Class: 250 Product Weight (lbs.): 140 Cubic Feet Per Carton: 36.75</p> | GC3611 | \$2600 | \$2800 | \$3109 | \$3363 | \$3720 | \$3856 | \$4168 | \$4758 | \$5053 | \$5602 | \$6361 | \$6361 |
| | | OVERALL DIMENSIONS W D H | | | SEAT DIMENSIONS W D H | | | BACK DIMENSIONS W H | | | | | |
| | | 37 | 37.5 | 38 | 30 | 20 | 18 | 30 | 21 | | | | |

Sleep surface is 30"W x 77"L
SSU armcap option - **Add \$172 list upcharge**
For users up to 350 lbs.

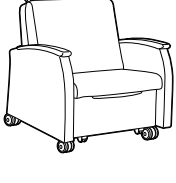
| DESCRIPTION | MODEL# | STANDARD FABRIC GRADES | | | | | | | | | | | |
|--|---------|------------------------------------|--------|--------|---------------------------------|--------|--------|-------------------------------|--------|--------|--------|--------|--------|
| | | COM | 2 | 3 | 4 | 5 | 6 | 7 | 8 | 9 | 10 | 11 | 12 |
|  <p>Lounge Chair/Sleeper Chair Single, Wide, Casters COM Yardage: 9 Freight Class: 250 Product Weight (lbs.): 140 Cubic Feet Per Carton: 36.75</p> | GC3611C | \$2600 | \$2800 | \$3109 | \$3363 | \$3720 | \$3856 | \$4168 | \$4758 | \$5053 | \$5602 | \$6361 | \$6361 |
| | | OVERALL DIMENSIONS W D H | | | SEAT DIMENSIONS W D H | | | BACK DIMENSIONS W H | | | | | |
| | | 37 | 37.5 | 38 | 30 | 20 | 18 | 30 | 21 | | | | |

Sleep surface is 30"W x 77"L
SSU armcap option - **Add \$172 list upcharge**
For users up to 350 lbs.

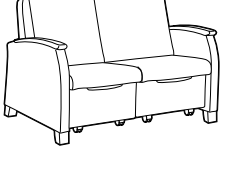
| DESCRIPTION | MODEL# | STANDARD FABRIC GRADES | | | | | | | | | | | |
|---|--------|------------------------------------|--------|--------|---------------------------------|--------|--------|-------------------------------|--------|--------|--------|--------|--------|
| | | COM | 2 | 3 | 4 | 5 | 6 | 7 | 8 | 9 | 10 | 11 | 12 |
|  <p>Lounge Chair/Sleeper Chair Double, Wood Legs COM Yardage: 11.75 Freight Class: 250 Product Weight (lbs.): 215 Cubic Feet Per Carton: 60</p> | GC3612 | \$3377 | \$3638 | \$4042 | \$4372 | \$4838 | \$5015 | \$5424 | \$6193 | \$6578 | \$7294 | \$8287 | \$8287 |
| | | OVERALL DIMENSIONS W D H | | | SEAT DIMENSIONS W D H | | | BACK DIMENSIONS W H | | | | | |
| | | 56 | 36 | 38 | 48 | 19.5 | 18 | 48 | 21 | | | | |

Sleep surface is 49"W x 77"L
SSU armcap option - **Add \$172 list upcharge**
For users up to 350 lbs. per seat position.

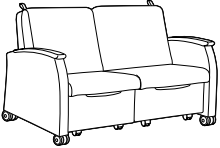
| DESCRIPTION | MODEL# | STANDARD FABRIC GRADES | | | | | | | | | | | |
|---|---------|------------------------------------|--------|--------|---------------------------------|--------|--------|-------------------------------|--------|--------|--------|--------|--------|
| | | COM | 2 | 3 | 4 | 5 | 6 | 7 | 8 | 9 | 10 | 11 | 12 |
|  Lounge Chair/Sleeper Chair Double, Casters COM Yardage: 11.75 Freight Class: 250 Product Weight (lbs.): 215 Cubic Feet Per Carton: 60 | GC3612C | \$3377 | \$3638 | \$4042 | \$4372 | \$4838 | \$5015 | \$5424 | \$6193 | \$6578 | \$7294 | \$8287 | \$8287 |
| | | OVERALL DIMENSIONS W D H | | | SEAT DIMENSIONS W D H | | | BACK DIMENSIONS W H | | | | | |
| | | 56 | 36 | 38 | 48 | 19.5 | 18 | 48 | 21 | | | | |

Sleep surface is 49"W x 77"L
SSU armcap option - **Add \$172 list upcharge**
For users up to 350 lbs. per seat position

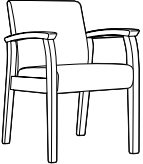
| DESCRIPTION | MODEL# | STANDARD FABRIC GRADES | | | | | | | | | | | |
|--|---------|------------------------------------|-------|-------|---------------------------------|--------|--------|-------------------------------|--------|--------|--------|--------|--------|
| | | COM | 2 | 3 | 4 | 5 | 6 | 7 | 8 | 9 | 10 | 11 | 12 |
|  Dining Chair Open Arms COM Yardage: 1.50 Freight Class: 250 Product Weight (lbs.): 30 Cubic Feet Per Carton: 13.25 | GC3616W | \$862 | \$896 | \$924 | \$967 | \$1027 | \$1049 | \$1101 | \$1199 | \$1248 | \$1340 | \$1467 | \$1467 |
| | | OVERALL DIMENSIONS W D H | | | SEAT DIMENSIONS W D H | | | BACK DIMENSIONS W H | | | | | |
| | | 23 | 23 | 34.5 | 19 | 17.5 | 18 | 19 | 16.5 | | | | |

SSU armcap option - **Add \$67 list upcharge**

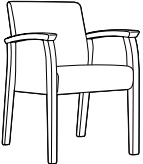
| DESCRIPTION | MODEL# | STANDARD FABRIC GRADES | | | | | | | | | | | |
|--|-----------|------------------------------------|--------|--------|---------------------------------|--------|--------|-------------------------------|--------|--------|--------|--------|--------|
| | | COM | 2 | 3 | 4 | 5 | 6 | 7 | 8 | 9 | 10 | 11 | 12 |
|  Dining Chair Closed Arms COM Yardage: 2 Freight Class: 250 Product Weight (lbs.): 40 Cubic Feet Per Carton: 13.25 | GC3616WCA | \$984 | \$1030 | \$1067 | \$1124 | \$1203 | \$1234 | \$1304 | \$1434 | \$1500 | \$1621 | \$1791 | \$1791 |
| | | OVERALL DIMENSIONS W D H | | | SEAT DIMENSIONS W D H | | | BACK DIMENSIONS W H | | | | | |
| | | 23 | 23 | 34.5 | 19 | 17.5 | 18 | 19 | 16.5 | | | | |

SSU armcap option - **Add \$67 list upcharge**

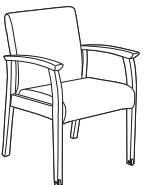
| DESCRIPTION | MODEL# | STANDARD FABRIC GRADES | | | | | | | | | | | |
|---|-----------|------------------------------------|-------|--------|---------------------------------|--------|--------|-------------------------------|--------|--------|--------|--------|--------|
| | | COM | 2 | 3 | 4 | 5 | 6 | 7 | 8 | 9 | 10 | 11 | 12 |
|  Dining Chair Open Arms, Front Casters COM Yardage: 1.50 Freight Class: 250 Product Weight (lbs.): 50 Cubic Feet Per Carton: 13.25 | GC3616WFC | \$959 | \$993 | \$1021 | \$1064 | \$1124 | \$1146 | \$1198 | \$1296 | \$1345 | \$1437 | \$1564 | \$1721 |
| | | OVERALL DIMENSIONS W D H | | | SEAT DIMENSIONS W D H | | | BACK DIMENSIONS W H | | | | | |
| | | 23 | 23 | 34.5 | 19 | 17.5 | 18 | 19 | 16.5 | | | | |

SSU armcap option - **Add \$67 list upcharge**

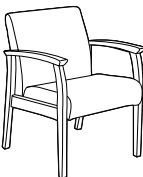
| DESCRIPTION | MODEL# | STANDARD FABRIC GRADES | | | | | | | | | | | |
|---|-----------------------|------------------------|---------------------------------|--------|--------|-------------------------------|--------|--------|--------|--------|--------|--------|--------|
| | | COM | 2 | 3 | 4 | 5 | 6 | 7 | 8 | 9 | 10 | 11 | 12 |
|  Low Back Single Seat Armchair Open Arms COM Yardage: 1.75 Freight Class: 250 Product Weight (lbs.): 36 Cubic Feet Per Carton: 17.50 | GC3620W | \$1023 | \$1063 | \$1097 | \$1146 | \$1215 | \$1242 | \$1303 | \$1418 | \$1474 | \$1581 | \$1729 | \$1729 |
| | GC3620WF Flex Back | \$1320 | \$1360 | \$1393 | \$1442 | \$1512 | \$1538 | \$1599 | \$1714 | \$1771 | \$1878 | \$2026 | \$2026 |
| OVERALL DIMENSIONS W D H | | | SEAT DIMENSIONS W D H | | | BACK DIMENSIONS W H | | | | | | | |
| | | 25 | 27 | 33 | 20.5 | 17.5 | 18 | 20.5 | 18 | | | | |

SSU armcap option - **Add \$67 list upcharge**

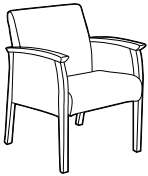
| DESCRIPTION | MODEL# | STANDARD FABRIC GRADES | | | | | | | | | | | |
|---|--------------------------------|---|--------|--------|-----------------|--------|--------|-----------------|--------|--------|--------|--------|--------|
| | | COM | 2 | 3 | 4 | 5 | 6 | 7 | 8 | 9 | 10 | 11 | 12 |
|  | GC3620WCA | \$1151 | \$1215 | \$1267 | \$1344 | \$1453 | \$1495 | \$1590 | \$1771 | \$1861 | \$2028 | \$2261 | \$2261 |
| | GC3620WFCA Flex Back | \$1447 | \$1511 | \$1563 | \$1640 | \$1749 | \$1791 | \$1887 | \$2067 | \$2157 | \$2324 | \$2557 | \$2557 |
| | | OVERALL DIMENSIONS | | | SEAT DIMENSIONS | | | BACK DIMENSIONS | | | | | |
| | | W | D | H | W | D | H | W | H | | | | |
| | | 25 | 27 | 33 | 20.5 | 17.5 | 18 | 20.5 | 18 | | | | |
| <p>Low Back Single Seat Armchair Closed Arms COM Yardage: 2.75 Freight Class: 250 Product Weight (lbs.): 44 Cubic Feet Per Carton: 17.50</p> | | SSU armcap option - Add \$67 list upcharge | | | | | | | | | | | |

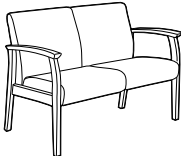
| DESCRIPTION | MODEL# | STANDARD FABRIC GRADES | | | | | | | | | | | |
|--|----------------|---|--------|--------|-----------------|--------|--------|-----------------|--------|--------|--------|--------|--------|
| | | COM | 2 | 3 | 4 | 5 | 6 | 7 | 8 | 9 | 10 | 11 | 12 |
|  | GC3621W | \$1667 | \$1743 | \$1804 | \$1895 | \$2025 | \$2074 | \$2187 | \$2399 | \$2505 | \$2704 | \$2978 | \$2978 |
| | | | | | | | | | | | | | |
| | | OVERALL DIMENSIONS | | | SEAT DIMENSIONS | | | BACK DIMENSIONS | | | | | |
| | | W | D | H | W | D | H | W | H | | | | |
| | | 45 | 27 | 33 | 40 | 17.5 | 18 | 40 | 18 | | | | |
| <p>Low Back Two Seat Chair No Center Arm, Open Arms COM Yardage: 3.25 Freight Class: 300 Product Weight (lbs.): 72 Cubic Feet Per Carton: 45.75</p> | | SSU armcap option - Add \$67 list upcharge | | | | | | | | | | | |

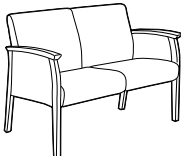
| DESCRIPTION | MODEL# | STANDARD FABRIC GRADES | | | | | | | | | | | |
|--|------------------|---|--------|--------|-----------------|--------|--------|-----------------|--------|--------|--------|--------|--------|
| | | COM | 2 | 3 | 4 | 5 | 6 | 7 | 8 | 9 | 10 | 11 | 12 |
|  | GC3621WCA | \$1806 | \$1894 | \$1965 | \$2070 | \$2219 | \$2275 | \$2406 | \$2652 | \$2775 | \$3003 | \$3319 | \$3319 |
| | | | | | | | | | | | | | |
| | | OVERALL DIMENSIONS | | | SEAT DIMENSIONS | | | BACK DIMENSIONS | | | | | |
| | | W | D | H | W | D | H | W | H | | | | |
| | | 45 | 27 | 33 | 40 | 17.5 | 18 | 40 | 18 | | | | |
| <p>Low Back Two Seat Chair No Center Arm, Closed Arms COM Yardage: 3.25 Freight Class: 300 Product Weight (lbs.): 84 Cubic Feet Per Carton: 45.75</p> | | SSU armcap option - Add \$67 list upcharge | | | | | | | | | | | |

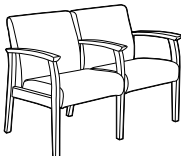
| DESCRIPTION | MODEL# | STANDARD FABRIC GRADES | | | | | | | | | | | |
|--|----------------|--|--------|--------|-----------------|--------|--------|-----------------|--------|--------|--------|--------|--------|
| | | COM | 2 | 3 | 4 | 5 | 6 | 7 | 8 | 9 | 10 | 11 | 12 |
|  | GC3622W | \$1876 | \$1952 | \$2013 | \$2105 | \$2234 | \$2283 | \$2396 | \$2609 | \$2715 | \$2913 | \$3188 | \$3188 |
| | | | | | | | | | | | | | |
| | | OVERALL DIMENSIONS | | | SEAT DIMENSIONS | | | BACK DIMENSIONS | | | | | |
| | | W | D | H | W | D | H | W | H | | | | |
| | | 46 | 27 | 33 | 20.5 | 17.5 | 18 | 20.5 | 18 | | | | |
| <p>Low Back Two Seat Chair Full Center Arm, Open Arms COM Yardage: 3.25 Freight Class: 300 Product Weight (lbs.): 58 Cubic Feet Per Carton: 45.75</p> | | SSU armcap option - Add \$101 list upcharge | | | | | | | | | | | |

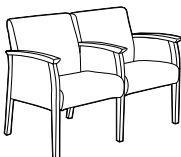
| DESCRIPTION | MODEL# | STANDARD FABRIC GRADES | | | | | | | | | | | |
|--|------------------|--|--------|--------|-----------------|--------|--------|-----------------|--------|--------|--------|--------|--------|
| | | COM | 2 | 3 | 4 | 5 | 6 | 7 | 8 | 9 | 10 | 11 | 12 |
|  | GC3622WCA | \$2075 | \$2179 | \$2264 | \$2390 | \$2569 | \$2637 | \$2794 | \$3088 | \$3236 | \$3510 | \$3890 | \$3890 |
| | | | | | | | | | | | | | |
| | | OVERALL DIMENSIONS | | | SEAT DIMENSIONS | | | BACK DIMENSIONS | | | | | |
| | | W | D | H | W | D | H | W | H | | | | |
| | | 46 | 27 | 33 | 20.5 | 17.5 | 18 | 20.5 | 18 | | | | |
| <p>Low Back Two Seat Chair Full Center Arm, Closed Arms COM Yardage: 4.50 Freight Class: 300 Product Weight (lbs.): 68 Cubic Feet Per Carton: 45.75</p> | | SSU armcap option - Add \$101 list upcharge | | | | | | | | | | | |

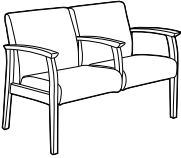
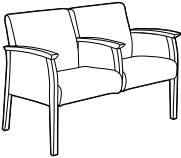
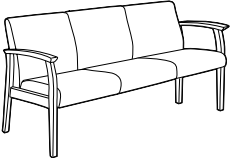
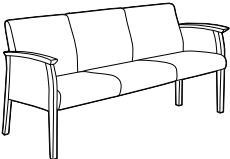
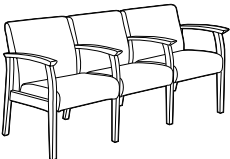
| DESCRIPTION | MODEL# | STANDARD FABRIC GRADES | | | | | | | | | | | |
|---|-----------|---|--------|--------|-----------------|--------|--------|-----------------|--------|--------|--------|--------|--------|
| | | COM | 2 | 3 | 4 | 5 | 6 | 7 | 8 | 9 | 10 | 11 | 12 |
|  <p>Low Back Two Seat Chair Half Center Arm, Open Arms COM Yardage: 3.25 Freight Class: 300 Product Weight (lbs.): 64 Cubic Feet Per Carton: 45.75</p> | GC3623W | \$1842 | \$1917 | \$1978 | \$2070 | \$2199 | \$2248 | \$2361 | \$2574 | \$2680 | \$2878 | \$3153 | \$3153 |
| | | OVERALL DIMENSIONS | | | SEAT DIMENSIONS | | | BACK DIMENSIONS | | | | | |
| | | W | D | H | W | D | H | W | H | | | | |
| | | 46 | 27 | 33 | 20.5 | 17.5 | 18 | 20.5 | 18 | | | | |
| | | SSU armcap option - Add \$101 list upcharge | | | | | | | | | | | |
|  <p>Low Back Two Seat Chair Half Center Arm, Closed Arms COM Yardage: 4.50 Freight Class: 300 Product Weight (lbs.): 74 Cubic Feet Per Carton: 45.75</p> | GC3623WCA | \$2040 | \$2145 | \$2229 | \$2356 | \$2535 | \$2603 | \$2759 | \$3054 | \$3201 | \$3475 | \$3856 | \$3856 |
| | | OVERALL DIMENSIONS | | | SEAT DIMENSIONS | | | BACK DIMENSIONS | | | | | |
| | | W | D | H | W | D | H | W | H | | | | |
| | | 46 | 27 | 33 | 20.5 | 17.5 | 18 | 20.5 | 18 | | | | |
| | | SSU armcap option - Add \$101 list upcharge | | | | | | | | | | | |
|  <p>Low Back Three Seat Chair No Center Arm, Open Arms COM Yardage: 4.25 Freight Class: 300 Product Weight (lbs.): 80 Cubic Feet Per Carton: 65.25</p> | GC3624W | \$2197 | \$2296 | \$2376 | \$2495 | \$2664 | \$2728 | \$2876 | \$3155 | \$3294 | \$3552 | \$3912 | \$3912 |
| | | OVERALL DIMENSIONS | | | SEAT DIMENSIONS | | | BACK DIMENSIONS | | | | | |
| | | W | D | H | W | D | H | W | H | | | | |
| | | 65 | 27 | 33 | 60 | 17.5 | 18 | 60 | 18 | | | | |
| | | SSU armcap option - Add \$67 list upcharge | | | | | | | | | | | |
|  <p>Low Back Three Seat Chair No Center Arm, Closed Arms COM Yardage: 5.25 Freight Class: 300 Product Weight (lbs.): 90 Cubic Feet Per Carton: 65.25</p> | GC3624WCA | \$2327 | \$2449 | \$2548 | \$2695 | \$2904 | \$2983 | \$3166 | \$3509 | \$3682 | \$4001 | \$4445 | \$4445 |
| | | OVERALL DIMENSIONS | | | SEAT DIMENSIONS | | | BACK DIMENSIONS | | | | | |
| | | W | D | H | W | D | H | W | H | | | | |
| | | 65 | 27 | 33 | 60 | 17.5 | 18 | 60 | 18 | | | | |
| | | SSU armcap option - Add \$67 list upcharge | | | | | | | | | | | |
|  <p>Low Back Three Seat Chair Full Center Arms, Open Arms COM Yardage: 4.75 Freight Class: 300 Product Weight (lbs.): 90 Cubic Feet Per Carton: 65.25</p> | GC3625W | \$2672 | \$2782 | \$2872 | \$3005 | \$3194 | \$3265 | \$3431 | \$3742 | \$3897 | \$4187 | \$4588 | \$4588 |
| | | OVERALL DIMENSIONS | | | SEAT DIMENSIONS | | | BACK DIMENSIONS | | | | | |
| | | W | D | H | W | D | H | W | H | | | | |
| | | 69 | 27 | 33 | 20.5 | 17.5 | 18 | 20.5 | 18 | | | | |
| | | SSU armcap option - Add \$134 list upcharge | | | | | | | | | | | |

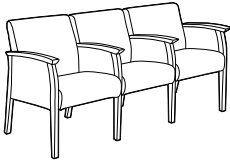
| DESCRIPTION | MODEL# | STANDARD FABRIC GRADES | | | | | | | | | | | |
|---|-----------|---------------------------|----------|----------|------------------------|----------|----------|------------------------|----------|----------|--------|--------|--------|
| | | COM | 2 | 3 | 4 | 5 | 6 | 7 | 8 | 9 | 10 | 11 | 12 |
|  | GC3625WCA | \$2941 | \$3086 | \$3204 | \$3379 | \$3628 | \$3722 | \$3939 | \$4349 | \$4554 | \$4934 | \$5463 | \$5463 |
| | | OVERALL DIMENSIONS | | | SEAT DIMENSIONS | | | BACK DIMENSIONS | | | | | |
| | | | W | D | H | W | D | H | W | H | | | |
| | | | 69 | 27 | 33 | 20.5 | 17.5 | 18 | 20.5 | 18 | | | |

Low Back Three Seat Chair Full Center Arms, Closed Arms
 COM Yardage: 6.25
 Freight Class: 300
 Product Weight (lbs.): 100
 Cubic Feet Per Carton: 65.25

SSU armcap option - **Add \$134 list upcharge**

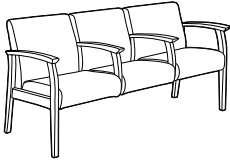
| DESCRIPTION | MODEL# | STANDARD FABRIC GRADES | | | | | | | | | | | |
|---|---------|---------------------------|----------|----------|------------------------|----------|----------|------------------------|----------|----------|--------|--------|--------|
| | | COM | 2 | 3 | 4 | 5 | 6 | 7 | 8 | 9 | 10 | 11 | 12 |
|  | GC3626W | \$2604 | \$2714 | \$2804 | \$2937 | \$3126 | \$3197 | \$3363 | \$3674 | \$3829 | \$4119 | \$4520 | \$4520 |
| | | OVERALL DIMENSIONS | | | SEAT DIMENSIONS | | | BACK DIMENSIONS | | | | | |
| | | | W | D | H | W | D | H | W | H | | | |
| | | | 69 | 27 | 33 | 20.5 | 17.5 | 18 | 20.5 | 18 | | | |

Low Back Three Seat Chair Half Center Arms, Open Arms
 COM Yardage: 4.75
 Freight Class: 300
 Product Weight (lbs.): 85
 Cubic Feet Per Carton: 65.25

SSU armcap option - **Add \$134 list upcharge**

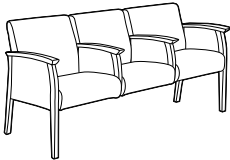
| DESCRIPTION | MODEL# | STANDARD FABRIC GRADES | | | | | | | | | | | |
|--|-----------|---------------------------|----------|----------|------------------------|----------|----------|------------------------|----------|----------|--------|--------|--------|
| | | COM | 2 | 3 | 4 | 5 | 6 | 7 | 8 | 9 | 10 | 11 | 12 |
|  | GC3626WCA | \$2872 | \$3017 | \$3135 | \$3311 | \$3559 | \$3654 | \$3871 | \$4280 | \$4485 | \$4865 | \$5394 | \$5394 |
| | | OVERALL DIMENSIONS | | | SEAT DIMENSIONS | | | BACK DIMENSIONS | | | | | |
| | | | W | D | H | W | D | H | W | H | | | |
| | | | 69 | 27 | 33 | 20.5 | 17.5 | 18 | 20.5 | 18 | | | |

Low Back Three Seat Chair Half Center Arms, Closed Arms
 COM Yardage: 6
 Freight Class: 300
 Product Weight (lbs.): 90
 Cubic Feet Per Carton: 65.25

SSU armcap option - **Add \$134 list upcharge**

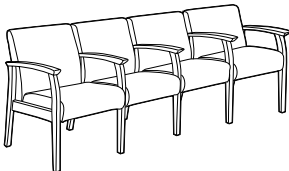
| DESCRIPTION | MODEL# | STANDARD FABRIC GRADES | | | | | | | | | | | |
|---|---------|---------------------------|----------|----------|------------------------|----------|----------|------------------------|----------|----------|--------|--------|--------|
| | | COM | 2 | 3 | 4 | 5 | 6 | 7 | 8 | 9 | 10 | 11 | 12 |
|  | GC3628W | \$3784 | \$3924 | \$4037 | \$4206 | \$4444 | \$4535 | \$4744 | \$5137 | \$5333 | \$5698 | \$6206 | \$6206 |
| | | OVERALL DIMENSIONS | | | SEAT DIMENSIONS | | | BACK DIMENSIONS | | | | | |
| | | | W | D | H | W | D | H | W | H | | | |
| | | | 93 | 27 | 33 | 20.5 | 17.5 | 18 | 20.5 | 18 | | | |

Low Back Four Seat Chair Full Center Arms, Open Arms
 COM Yardage: 6
 Freight Class: 400
 Product Weight (lbs.): 150
 Cubic Feet Per Carton: 183

SSU armcap option - **Add \$168 list upcharge**

- Shipped RTA (Ready to Assemble) in 2 cartons

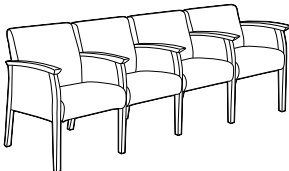
| DESCRIPTION | MODEL# | STANDARD FABRIC GRADES | | | | | | | | | | | |
|---|-----------|---------------------------|----------|----------|------------------------|----------|----------|------------------------|----------|----------|--------|--------|--------|
| | | COM | 2 | 3 | 4 | 5 | 6 | 7 | 8 | 9 | 10 | 11 | 12 |
|  | GC3628WCA | \$4117 | \$4304 | \$4455 | \$4679 | \$4997 | \$5118 | \$5396 | \$5920 | \$6182 | \$6669 | \$7345 | \$7345 |
| | | OVERALL DIMENSIONS | | | SEAT DIMENSIONS | | | BACK DIMENSIONS | | | | | |
| | | | W | D | H | W | D | H | W | H | | | |
| | | | 93 | 27 | 33 | 20.5 | 17.5 | 18 | 20.5 | 18 | | | |

Low Back Four Seat Chair Full Center Arms, Closed Arms
 COM Yardage: 8
 Freight Class: 400
 Product Weight (lbs.): 160
 Cubic Feet Per Carton: 183

SSU armcap option - **Add \$168 list upcharge**

- Shipped RTA (Ready to Assemble) in 2 cartons

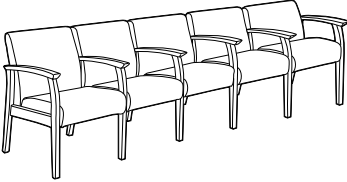
| DESCRIPTION | MODEL# | STANDARD FABRIC GRADES | | | | | | | | | | | |
|---|---------|------------------------|--------|--------|-----------------|--------|--------|-----------------|--------|--------|--------|--------|--------|
| | | COM | 2 | 3 | 4 | 5 | 6 | 7 | 8 | 9 | 10 | 11 | 12 |
|  <p>Low Back Five Seat Chair Full Center Arms, Open Arms COM Yardage: 7.50 Freight Class: 400 Product Weight (lbs.): 170 Cubic Feet Per Carton: 222</p> | GC3630W | COM | 2 | 3 | 4 | 5 | 6 | 7 | 8 | 9 | 10 | 11 | 12 |
| | | \$4145 | \$4319 | \$4461 | \$4671 | \$4968 | \$5082 | \$5343 | \$5834 | \$6080 | \$6536 | \$7170 | \$7170 |
| | | OVERALL DIMENSIONS | | | SEAT DIMENSIONS | | | BACK DIMENSIONS | | | | | |
| | | W | D | H | W | D | H | W | H | | | | |
| | | 115 | 27 | 33 | 20.5 | 17.5 | 18 | 20.5 | 18 | | | | |
| <p>SSU armcap option - Add \$201 list upcharge</p> <p>• Shipped RTA (Ready to Assemble) in 2 cartons</p> | | | | | | | | | | | | | |

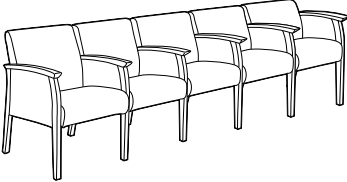
| | | | | | | | | | | | | | |
|---|-----------|--------------------|--------|--------|-----------------|--------|--------|-----------------|--------|--------|--------|--------|--------|
|  <p>Low Back Five Seat Chair Full Center Arms, Closed Arms COM Yardage: 10 Freight Class: 400 Product Weight (lbs.): 180 Cubic Feet Per Carton: 222</p> | GC3630WCA | COM | 2 | 3 | 4 | 5 | 6 | 7 | 8 | 9 | 10 | 11 | 12 |
| | | \$4541 | \$4774 | \$4962 | \$5243 | \$5640 | \$5791 | \$6139 | \$6794 | \$7121 | \$7730 | \$8575 | \$8575 |
| | | OVERALL DIMENSIONS | | | SEAT DIMENSIONS | | | BACK DIMENSIONS | | | | | |
| | | W | D | H | W | D | H | W | H | | | | |
| | | 115 | 27 | 33 | 20.5 | 17.5 | 18 | 20.5 | 18 | | | | |
| <p>SSU armcap option - Add \$201 list upcharge</p> <p>• Shipped RTA (Ready to Assemble) in 2 cartons</p> | | | | | | | | | | | | | |

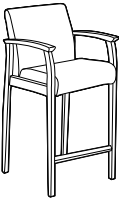
| | | | | | | | | | | | | | |
|--|---------|--------------------|--------|--------|-----------------|--------|--------|-----------------|--------|--------|--------|--------|--------|
|  <p>Low Back Single Seat Armchair Open Arms, Post Hip Surgery Height COM Yardage: 1.50 Freight Class: 250 Product Weight (lbs.): 57 Cubic Feet Per Carton: 20</p> | GC3636W | COM | 2 | 3 | 4 | 5 | 6 | 7 | 8 | 9 | 10 | 11 | 12 |
| | | \$1539 | \$1574 | \$1603 | \$1645 | \$1704 | \$1727 | \$1779 | \$1877 | \$1926 | \$2018 | \$2145 | \$2145 |
| | | OVERALL DIMENSIONS | | | SEAT DIMENSIONS | | | BACK DIMENSIONS | | | | | |
| | | W | D | H | W | D | H | W | H | | | | |
| | | 23 | 26 | 40.5 | 19 | 17.5 | 25.5 | 19 | 15.5 | | | | |
| <p>SSU armcap option - Add \$67 list upcharge</p> | | | | | | | | | | | | | |

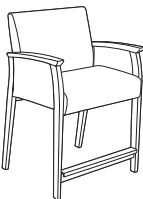
| | | | | | | | | | | | | | |
|--|-----------|--------------------|--------|--------|-----------------|--------|--------|-----------------|--------|--------|--------|--------|--------|
|  <p>Low Back Single Seat Armchair Closed Arms, Post Hip Surgery Height COM Yardage: 2 Freight Class: 250 Product Weight (lbs.): 62 Cubic Feet Per Carton: 20</p> | GC3636WCA | COM | 2 | 3 | 4 | 5 | 6 | 7 | 8 | 9 | 10 | 11 | 12 |
| | | \$1696 | \$1574 | \$1603 | \$1645 | \$1704 | \$1727 | \$1779 | \$1877 | \$1926 | \$2018 | \$2145 | \$2145 |
| | | OVERALL DIMENSIONS | | | SEAT DIMENSIONS | | | BACK DIMENSIONS | | | | | |
| | | W | D | H | W | D | H | W | H | | | | |
| | | 23 | 26 | 40.5 | 19 | 17.5 | 25.5 | 19 | 15.5 | | | | |
| <p>SSU armcap option - Add \$67 list upcharge</p> | | | | | | | | | | | | | |

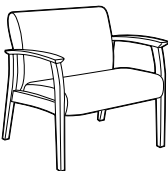
| | | | | | | | | | | | | | |
|---|---------|--------------------|--------|--------|-----------------|--------|--------|-----------------|--------|--------|--------|--------|--------|
|  <p>Bariatric Low Back Single Seat Armchair Open Arms COM Yardage: 2.50 Freight Class: 250 Product Weight (lbs.): 55 Cubic Feet Per Carton: 26.50</p> | GC3637W | COM | 2 | 3 | 4 | 5 | 6 | 7 | 8 | 9 | 10 | 11 | 12 |
| | | \$1359 | \$1416 | \$1463 | \$1534 | \$1634 | \$1671 | \$1758 | \$1922 | \$2004 | \$2156 | \$2367 | \$2367 |
| | | OVERALL DIMENSIONS | | | SEAT DIMENSIONS | | | BACK DIMENSIONS | | | | | |
| | | W | D | H | W | D | H | W | H | | | | |
| | | 35 | 27 | 33 | 30 | 17.5 | 18 | 30 | 18 | | | | |
| <p>SSU armcap option - Add \$67 list upcharge</p> <p>• For users up to 500 lbs.</p> | | | | | | | | | | | | | |

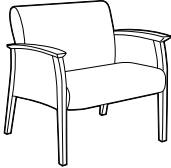
| DESCRIPTION | MODEL# | STANDARD FABRIC GRADES | | | | | | | | | | | |
|---|------------------|---|--------|--------|-----------------|--------|--------|-----------------|--------|--------|--------|--------|--------|
| | | COM | 2 | 3 | 4 | 5 | 6 | 7 | 8 | 9 | 10 | 11 | 12 |
|  <p>Bariatric Low Back Single Seat Armchair Closed Arms COM Yardage: 3.50 Freight Class: 250 Product Weight (lbs.): 65 Cubic Feet Per Carton: 26.50</p> | GC3637WCA | \$1486 | \$1568 | \$1634 | \$1732 | \$1871 | \$1924 | \$2046 | \$2275 | \$2390 | \$2603 | \$2899 | \$2899 |
| | | OVERALL DIMENSIONS | | | SEAT DIMENSIONS | | | BACK DIMENSIONS | | | | | |
| | | W | D | H | W | D | H | W | H | | | | |
| | | 35 | 27 | 33 | 30 | 17.5 | 18 | 30 | 18 | | | | |
| | | SSU armcap option - Add \$67 list upcharge | | | | | | | | | | | |
| | | • For users up to 500 lbs. | | | | | | | | | | | |

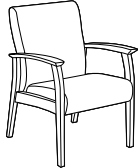
| | | | | | | | | | | | | | |
|---|------------------------------|---|--------|--------|-----------------|--------|--------|-----------------|--------|--------|--------|--------|--------|
|  <p>Medium Back Armchair Open Arms COM Yardage: 1.75 Freight Class: 300 Product Weight (lbs.): 38 Cubic Feet Per Carton: 20</p> | GC3631W | \$1113 | \$1154 | \$1188 | \$1237 | \$1306 | \$1333 | \$1393 | \$1508 | \$1565 | \$1671 | \$1820 | \$1820 |
| | GC3631WF Flex Back | \$1413 | \$1453 | \$1486 | \$1535 | \$1605 | \$1631 | \$1692 | \$1807 | \$1864 | \$1971 | \$2119 | \$2119 |
| | | OVERALL DIMENSIONS | | | SEAT DIMENSIONS | | | BACK DIMENSIONS | | | | | |
| | W | D | H | W | D | H | W | H | | | | | |
| | | 25 | 27 | 36.5 | 20.5 | 17.5 | 18 | 20.5 | 21 | | | | |
| | | SSU armcap option - Add \$67 list upcharge | | | | | | | | | | | |

| | | | | | | | | | | | | | |
|--|--------------------------------|---|--------|--------|-----------------|--------|--------|-----------------|--------|--------|--------|--------|--------|
|  <p>Medium Back Armchair Closed Arms COM Yardage: 2.75 Freight Class: 250 Product Weight (lbs.): 46 Cubic Feet Per Carton: 20</p> | GC3631WCA | \$1262 | \$1326 | \$1378 | \$1455 | \$1564 | \$1606 | \$1702 | \$1882 | \$1972 | \$2139 | \$2372 | \$2372 |
| | GC3631WFCA Flex Back | \$1559 | \$1623 | \$1675 | \$1752 | \$1861 | \$1903 | \$1999 | \$2179 | \$2269 | \$2436 | \$2669 | \$2669 |
| | | OVERALL DIMENSIONS | | | SEAT DIMENSIONS | | | BACK DIMENSIONS | | | | | |
| | W | D | H | W | D | H | W | H | | | | | |
| | | 25 | 27 | 36.5 | 20.5 | 17.5 | 18 | 20.5 | 21 | | | | |
| | | SSU armcap option - Add \$67 list upcharge | | | | | | | | | | | |

| | | | | | | | | | | | | | |
|--|------------------------------|--|--------|--------|-----------------|--------|--------|-----------------|--------|--------|--------|--------|--------|
|  <p>High Back Armchair Open Arms, Split Back COM Yardage: 2.25 Freight Class: 300 Product Weight (lbs.): 48 Cubic Feet Per Carton: 27.50</p> | GC3632W | \$1235 | \$1287 | \$1330 | \$1392 | \$1482 | \$1516 | \$1594 | \$1741 | \$1816 | \$1953 | \$2143 | \$2143 |
| | GC3632WF Flex Back | \$1533 | \$1585 | \$1628 | \$1691 | \$1780 | \$1814 | \$1892 | \$2040 | \$2113 | \$2250 | \$2441 | \$2441 |
| | | OVERALL DIMENSIONS | | | SEAT DIMENSIONS | | | BACK DIMENSIONS | | | | | |
| | W | D | H | W | D | H | W | H | | | | | |
| | | 25 | 27 | 48.5 | 20.5 | 17.5 | 18 | 20.5 | 30 | | | | |
| | | Fold away headrest. SSU armcap option - Add \$67 list upcharge | | | | | | | | | | | |

| | | | | | | | | | | | | | |
|---|--------------------------------|--|--------|--------|-----------------|--------|--------|-----------------|--------|--------|--------|--------|--------|
|  <p>High Back Armchair Closed Arms, Split Back COM Yardage: 3 Freight Class: 250 Product Weight (lbs.): 56 Cubic Feet Per Carton: 27.50</p> | GC3632WCA | \$1388 | \$1458 | \$1515 | \$1599 | \$1718 | \$1763 | \$1868 | \$2064 | \$2163 | \$2345 | \$2599 | \$2599 |
| | GC3632WFCA Flex Back | \$1685 | \$1755 | \$1812 | \$1896 | \$2015 | \$2060 | \$2165 | \$2361 | \$2459 | \$2642 | \$2896 | \$2896 |
| | | OVERALL DIMENSIONS | | | SEAT DIMENSIONS | | | BACK DIMENSIONS | | | | | |
| | W | D | H | W | D | H | W | H | | | | | |
| | | 25 | 27 | 48.5 | 20.5 | 17.5 | 18 | 20.5 | 30 | | | | |
| | | Fold away headrest. SSU armcap option - Add \$67 list upcharge | | | | | | | | | | | |

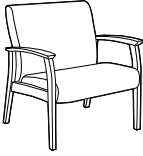
| DESCRIPTION | MODEL# | STANDARD FABRIC GRADES | | | | | | | | | | | |
|--|---------------------------|------------------------|--------|------------------------|--------|--------|------------------------|--------|--------|--------|--------|--------|--------|
| | | COM | 2 | 3 | 4 | 5 | 6 | 7 | 8 | 9 | 10 | 11 | 12 |
|  <p>Bariatric Medium Back Armchair Open Arms COM Yardage: 2.75 Freight Class: 300 Product Weight (lbs.): 60 Cubic Feet Per Carton: 30.50</p> | GC3638W | \$1412 | \$1473 | \$1599 | \$1677 | \$1785 | \$1827 | \$1922 | \$2103 | \$2193 | \$2360 | \$2593 | \$2593 |
| | OVERALL DIMENSIONS | | | SEAT DIMENSIONS | | | BACK DIMENSIONS | | | | | | |
| | W | D | H | W | D | H | W | H | | | | | |
| | 35 | 27 | 36.5 | 30 | 17.5 | 18 | 30 | 21 | | | | | |

SSU armcap option - **Add \$67 list upcharge**
 • For users up to 500 lbs.

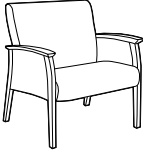
| | | | | | | | | | | | | | |
|--|---------------------------|--------|--------|------------------------|--------|--------|------------------------|--------|--------|--------|--------|--------|--------|
|  <p>Bariatric Medium Back Armchair Closed Arms COM Yardage: 3.75 Freight Class: 250 Product Weight (lbs.): 70 Cubic Feet Per Carton: 30.50</p> | GC3638WCA | \$1558 | \$1644 | \$1715 | \$1820 | \$1969 | \$2026 | \$2156 | \$2402 | \$2525 | \$2753 | \$3070 | \$3070 |
| | OVERALL DIMENSIONS | | | SEAT DIMENSIONS | | | BACK DIMENSIONS | | | | | | |
| | W | D | H | W | D | H | W | H | | | | | |
| | 35 | 27 | 36.5 | 30 | 17.5 | 18 | 30 | 21 | | | | | |

SSU armcap option - **Add \$67 list upcharge**
 • For users up to 500 lbs.

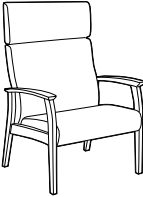
| | | | | | | | | | | | | | |
|---|---------------------------|--------|--------|------------------------|--------|--------|------------------------|--------|--------|--------|--------|--------|--------|
|  <p>Bariatric High Back Armchair Open Arms, Split Back COM Yardage: 3.75 Freight Class: 300 Product Weight (lbs.): 60 Cubic Feet Per Carton: 30.75</p> | GC3639W | \$1557 | \$1644 | \$1715 | \$1820 | \$1969 | \$2026 | \$2156 | \$2402 | \$2524 | \$2753 | \$3070 | \$3070 |
| | OVERALL DIMENSIONS | | | SEAT DIMENSIONS | | | BACK DIMENSIONS | | | | | | |
| | W | D | H | W | D | H | W | H | | | | | |
| | 35 | 27 | 48.5 | 30 | 17.5 | 18 | 30 | 30 | | | | | |

Fold away headrest.
 SSU armcap option - **Add \$67 list upcharge**
 • For users up to 500 lbs.

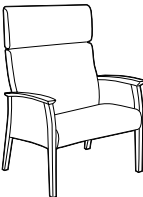
| | | | | | | | | | | | | | |
|--|---------------------------|--------|--------|------------------------|--------|--------|------------------------|--------|--------|--------|--------|--------|--------|
|  <p>Bariatric High Back Armchair Closed Arms, Split Back COM Yardage: 4.75 Freight Class: 250 Product Weight (lbs.): 68 Cubic Feet Per Carton: 30.75</p> | GC3639WCA | \$1704 | \$1815 | \$1905 | \$2038 | \$2227 | \$2298 | \$2464 | \$2775 | \$2930 | \$3219 | \$3621 | \$3621 |
| | OVERALL DIMENSIONS | | | SEAT DIMENSIONS | | | BACK DIMENSIONS | | | | | | |
| | W | D | H | W | D | H | W | H | | | | | |
| | 35 | 27 | 48.5 | 30 | 17.5 | 18 | 30 | 30 | | | | | |

Fold away headrest.
 SSU armcap option - **Add \$67 list upcharge**
 • For users up to 500 lbs.

| | | | | | | | | | | | | | |
|--|---------------------------|--------|--------|------------------------|--------|--------|------------------------|--------|--------|--------|--------|--------|--------|
|  <p>High Back Armchair Open Arms COM Yardage: 2.50 Freight Class: 300 Product Weight (lbs.): 48 Cubic Feet Per Carton: 27.50</p> | GC3655W | \$1154 | \$1212 | \$1259 | \$1329 | \$1429 | \$1467 | \$1553 | \$1717 | \$1799 | \$1952 | \$2163 | \$2163 |
| | GC3655WF Flex Back | \$1452 | \$1510 | \$1557 | \$1628 | \$1727 | \$1765 | \$1852 | \$2015 | \$2097 | \$2249 | \$2461 | \$2461 |
| | OVERALL DIMENSIONS | | | SEAT DIMENSIONS | | | BACK DIMENSIONS | | | | | | |
| W | D | H | W | D | H | W | H | | | | | | |
| | 25 | 27 | 48.5 | 20.5 | 17.5 | 18 | 20.5 | 30 | | | | | |

SSU armcap option - **Add \$67 list upcharge**

| DESCRIPTION | MODEL# | STANDARD FABRIC GRADES | | | | | | | | | | | | |
|--|-----------|---------------------------------|--------------------|--------|--------|-----------------|--------|--------|-----------------|--------|--------|--------|--------|--------|
| | | COM | 2 | 3 | 4 | 5 | 6 | 7 | 8 | 9 | 10 | 11 | 12 | |
|  <p>High Back Armchair Closed Arms COM Yardage: 3.25 Freight Class: 250 Product Weight (lbs.): 56 Cubic Feet Per Carton: 27.50</p> | GC3655WCA | \$1307 | \$1382 | \$1444 | \$1535 | \$1664 | \$1712 | \$1826 | \$2038 | \$2145 | \$2343 | \$2617 | \$2617 | |
| | | <p>GC3655WFCA Flex Back</p> | \$1603 | \$1679 | \$1740 | \$1832 | \$1961 | \$2010 | \$2123 | \$2336 | \$2442 | \$2640 | \$2915 | \$2915 |
| | | | OVERALL DIMENSIONS | | | SEAT DIMENSIONS | | | BACK DIMENSIONS | | | | | |
| | | W | D | H | W | D | H | W | H | | | | | |
| | | 25 | 27 | 48.5 | 20.5 | 17.5 | 18 | 20.5 | 30 | | | | | |

SSU armcap option - Add \$67 list upcharge

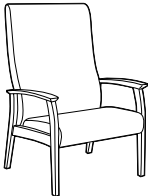
| DESCRIPTION | MODEL# | STANDARD FABRIC GRADES | | | | | | | | | | | |
|--|---------|------------------------|--------|--------|-----------------|--------|--------|-----------------|--------|--------|--------|--------|--------|
| | | COM | 2 | 3 | 4 | 5 | 6 | 7 | 8 | 9 | 10 | 11 | 12 |
|  <p>Bariatric High Back Armchair Open Arms COM Yardage: 3.50 Freight Class: 300 Product Weight (lbs.): 60 Cubic Feet Per Carton: 30.75</p> | GC3656W | \$1449 | \$1530 | \$1596 | \$1694 | \$1833 | \$1887 | \$2008 | \$2238 | \$2352 | \$2565 | \$2861 | \$2861 |
| | | OVERALL DIMENSIONS | | | SEAT DIMENSIONS | | | BACK DIMENSIONS | | | | | |
| | | | | W | D | H | W | D | H | W | H | | |
| | | 35 | 27 | 48.5 | 30 | 17.5 | 18 | 30 | 30 | | | | |

SSU armcap option - Add \$67 list upcharge

• For users up to 500 lbs.

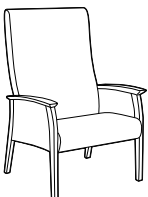
| DESCRIPTION | MODEL# | STANDARD FABRIC GRADES | | | | | | | | | | | |
|---|-----------|------------------------|--------|--------|-----------------|--------|--------|-----------------|--------|--------|--------|--------|--------|
| | | COM | 2 | 3 | 4 | 5 | 6 | 7 | 8 | 9 | 10 | 11 | 12 |
|  <p>Bariatric High Back Armchair Closed Arms COM Yardage: 4.50 Freight Class: 250 Product Weight (lbs.): 68 Cubic Feet Per Carton: 30.75</p> | GC3656WCA | \$1596 | \$1701 | \$1785 | \$1912 | \$2090 | \$2158 | \$2315 | \$2610 | \$2757 | \$3031 | \$3411 | \$3411 |
| | | OVERALL DIMENSIONS | | | SEAT DIMENSIONS | | | BACK DIMENSIONS | | | | | |
| | | | | W | D | H | W | D | H | W | H | | |
| | | 35 | 27 | 48.5 | 30 | 17.5 | 18 | 30 | 30 | | | | |

SSU armcap option - Add \$67 list upcharge

• For users up to 500 lbs.

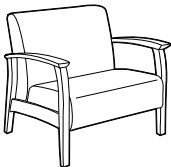
| DESCRIPTION | MODEL# | STANDARD FABRIC GRADES | | | | | | | | | | | |
|--|---------|------------------------|--------|--------|-----------------|--------|--------|-----------------|--------|--------|--------|--------|--------|
| | | COM | 2 | 3 | 4 | 5 | 6 | 7 | 8 | 9 | 10 | 11 | 12 |
|  <p>Bariatric Lounge Chair Open Arms COM Yardage: 3.25 Freight Class: 300 Product Weight (lbs.): 90 Cubic Feet Per Carton: 49.50</p> | GC3640W | \$1739 | \$1815 | \$1876 | \$1967 | \$2097 | \$2145 | \$2259 | \$2471 | \$2577 | \$2776 | \$3050 | \$3050 |
| | | OVERALL DIMENSIONS | | | SEAT DIMENSIONS | | | BACK DIMENSIONS | | | | | |
| | | | | W | D | H | W | D | H | W | H | | |
| | | 40 | 32 | 33 | 36 | 20 | 17.25 | 36 | 16 | | | | |

SSU armcap option - Add \$80 list upcharge

• For users up to 500 lbs.

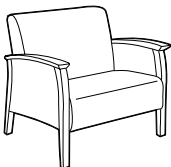
| DESCRIPTION | MODEL# | STANDARD FABRIC GRADES | | | | | | | | | | | |
|---|-----------|------------------------|--------|--------|-----------------|--------|--------|-----------------|--------|--------|--------|--------|--------|
| | | COM | 2 | 3 | 4 | 5 | 6 | 7 | 8 | 9 | 10 | 11 | 12 |
|  <p>Bariatric Lounge Chair Closed Arms COM Yardage: 5.75 Freight Class: 250 Product Weight (lbs.): 100 Cubic Feet Per Carton: 49.50</p> | GC3640WCA | \$1852 | \$1986 | \$2095 | \$2256 | \$2484 | \$2571 | \$2771 | \$3147 | \$3336 | \$3686 | \$4172 | \$4172 |
| | | OVERALL DIMENSIONS | | | SEAT DIMENSIONS | | | BACK DIMENSIONS | | | | | |
| | | | | W | D | H | W | D | H | W | H | | |
| | | 40 | 32 | 33 | 36 | 20 | 17.25 | 36 | 16 | | | | |

SSU armcap option - Add \$80 list upcharge

• For users up to 500 lbs.

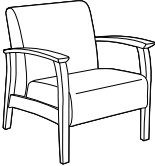
| DESCRIPTION | MODEL# | STANDARD FABRIC GRADES | | | | | | | | | | | |
|--|---------|--|--------|--------|-----------------|--------|--------|-----------------|--------|--------|--------|--------|--------|
| | | COM | 2 | 3 | 4 | 5 | 6 | 7 | 8 | 9 | 10 | 11 | 12 |
|  | GC3641W | \$1412 | \$1470 | \$1517 | \$1588 | \$1687 | \$1725 | \$1812 | \$1975 | \$2057 | \$2209 | \$2421 | \$2421 |
| | | SSU armcap option - Add \$80 list upcharge | | | | | | | | | | | |
| | | OVERALL DIMENSIONS | | | SEAT DIMENSIONS | | | BACK DIMENSIONS | | | | | |
| | | W | D | H | W | D | H | W | H | | | | |
| | | 29 | 32 | 33 | 23.5 | 20 | 17.25 | 23 | 16 | | | | |
| <p>Lounge Chair Open Arms COM Yardage: 2.50 Freight Class: 300 Product Weight (lbs.): 38 Cubic Feet Per Carton: 29.50</p> | | | | | | | | | | | | | |

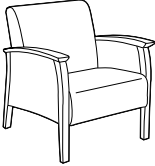
| DESCRIPTION | MODEL# | STANDARD FABRIC GRADES | | | | | | | | | | | |
|--|-----------|--|--------|--------|-----------------|--------|--------|-----------------|--------|--------|--------|--------|--------|
| | | COM | 2 | 3 | 4 | 5 | 6 | 7 | 8 | 9 | 10 | 11 | 12 |
|  | GC3641WCA | \$1553 | \$1640 | \$1711 | \$1817 | \$1965 | \$2022 | \$2152 | \$2398 | \$2521 | \$2749 | \$3065 | \$3065 |
| | | SSU armcap option - Add \$80 list upcharge | | | | | | | | | | | |
| | | OVERALL DIMENSIONS | | | SEAT DIMENSIONS | | | BACK DIMENSIONS | | | | | |
| | | W | D | H | W | D | H | W | H | | | | |
| | | 29 | 32 | 33 | 23.5 | 20 | 17.25 | 23 | 16 | | | | |
| <p>Lounge Chair Closed Arms COM Yardage: 3.75 Freight Class: 300 Product Weight (lbs.): 46 Cubic Feet Per Carton: 29.50</p> | | | | | | | | | | | | | |

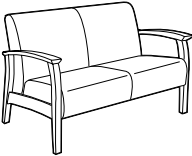
| DESCRIPTION | MODEL# | STANDARD FABRIC GRADES | | | | | | | | | | | |
|--|---------|--|--------|--------|-----------------|--------|--------|-----------------|--------|--------|--------|--------|--------|
| | | COM | 2 | 3 | 4 | 5 | 6 | 7 | 8 | 9 | 10 | 11 | 12 |
|  | GC3642W | \$2003 | \$2096 | \$2171 | \$2284 | \$2443 | \$2502 | \$2642 | \$2904 | \$3035 | \$3279 | \$3616 | \$3616 |
| | | SSU armcap option - Add \$80 list upcharge | | | | | | | | | | | |
| | | OVERALL DIMENSIONS | | | SEAT DIMENSIONS | | | BACK DIMENSIONS | | | | | |
| | | W | D | H | W | D | H | W | H | | | | |
| | | 52 | 32 | 33 | 48 | 20 | 17.25 | 48 | 16 | | | | |
| <p>Two Seat Sofa Open Arms COM Yardage: 4 Freight Class: 300 Product Weight (lbs.): 95 Cubic Feet Per Carton: 49.50</p> | | | | | | | | | | | | | |

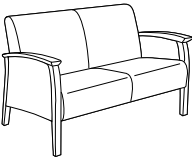
| DESCRIPTION | MODEL# | STANDARD FABRIC GRADES | | | | | | | | | | | |
|--|-----------|--|--------|--------|-----------------|--------|--------|-----------------|--------|--------|--------|--------|--------|
| | | COM | 2 | 3 | 4 | 5 | 6 | 7 | 8 | 9 | 10 | 11 | 12 |
|  | GC3642WCA | \$2138 | \$2266 | \$2370 | \$2524 | \$2742 | \$2825 | \$3017 | \$3377 | \$3557 | \$3892 | \$4357 | \$4357 |
| | | SSU armcap option - Add \$80 list upcharge | | | | | | | | | | | |
| | | OVERALL DIMENSIONS | | | SEAT DIMENSIONS | | | BACK DIMENSIONS | | | | | |
| | | W | D | H | W | D | H | W | H | | | | |
| | | 52 | 32 | 33 | 48 | 20 | 17.25 | 48 | 16 | | | | |
| <p>Two Seat Sofa Closed Arms COM Yardage: 5.50 Freight Class: 250 Product Weight (lbs.): 105 Cubic Feet Per Carton: 49.50</p> | | | | | | | | | | | | | |

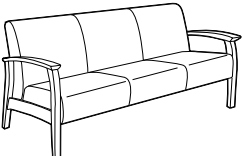
| DESCRIPTION | MODEL# | STANDARD FABRIC GRADES | | | | | | | | | | | |
|--|---------|--|--------|--------|-----------------|--------|--------|-----------------|--------|--------|--------|--------|--------|
| | | COM | 2 | 3 | 4 | 5 | 6 | 7 | 8 | 9 | 10 | 11 | 12 |
|  | GC3643W | \$2804 | \$2949 | \$3068 | \$3243 | \$3491 | \$3586 | \$3803 | \$4212 | \$4417 | \$4797 | \$5326 | \$5326 |
| | | SSU armcap option - Add \$80 list upcharge | | | | | | | | | | | |
| | | OVERALL DIMENSIONS | | | SEAT DIMENSIONS | | | BACK DIMENSIONS | | | | | |
| | | W | D | H | W | D | H | W | H | | | | |
| | | 75 | 32 | 33 | 71 | 20 | 17.25 | 71 | 16 | | | | |
| <p>Three Seat Sofa Open Arms COM Yardage: 6.25 Freight Class: 300 Product Weight (lbs.): 130 Cubic Feet Per Carton: 69.50</p> | | | | | | | | | | | | | |

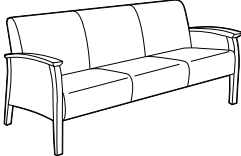
| DESCRIPTION | MODEL# | STANDARD FABRIC GRADES | | | | | | | | | | | |
|--|-----------|------------------------|--------|--------|-----------------|--------|--------|-----------------|--------|--------|--------|--------|--------|
| | | COM | 2 | 3 | 4 | 5 | 6 | 7 | 8 | 9 | 10 | 11 | 12 |
|  <p>Three Seat Sofa Closed Arms COM Yardage: 7.50 Freight Class: 250 Product Weight (lbs.): 140 Cubic Feet Per Carton: 69.50</p> | GC3643WCA | \$2945 | \$3120 | \$3261 | \$3472 | \$3770 | \$3883 | \$4144 | \$4635 | \$4881 | \$5337 | \$5971 | \$5971 |
| | | OVERALL DIMENSIONS | | | SEAT DIMENSIONS | | | BACK DIMENSIONS | | | | | |
| | | W | D | H | W | D | H | W | H | | | | |
| | | | 75 | 32 | 33 | 71 | 20 | 17.25 | 71 | 16 | | | |

SSU armcap option - Add \$80 list upcharge

| DESCRIPTION | MODEL# | STANDARD FABRIC GRADES | | | | | | | | | | | |
|---|---------|------------------------|-------|--------|-----------------|--------|--------|-----------------|--------|--------|--------|--------|--------|
| | | COM | 2 | 3 | 4 | 5 | 6 | 7 | 8 | 9 | 10 | 11 | 12 |
|  <p>Single Seat Bench COM Yardage: 1.25 Freight Class: 250 Product Weight (lbs.): 26 Cubic Feet Per Carton: 10.25</p> | GC3651W | \$969 | \$999 | \$1025 | \$1063 | \$1117 | \$1143 | \$1192 | \$1270 | \$1330 | \$1397 | \$1535 | \$1682 |
| | | OVERALL DIMENSIONS | | | SEAT DIMENSIONS | | | BACK DIMENSIONS | | | | | |
| | | W | D | H | W | D | H | W | H | | | | |
| | | | 26.5 | 22.5 | 19 | | | | | | | | |

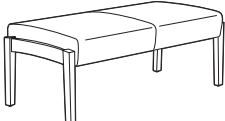
| DESCRIPTION | MODEL# | STANDARD FABRIC GRADES | | | | | | | | | | | |
|---|---------|------------------------|--------|--------|-----------------|--------|--------|-----------------|--------|--------|--------|--------|--------|
| | | COM | 2 | 3 | 4 | 5 | 6 | 7 | 8 | 9 | 10 | 11 | 12 |
|  <p>Two Seat Bench COM Yardage: 2 Freight Class: 250 Product Weight (lbs.): 41 Cubic Feet Per Carton: 20.25</p> | GC3652W | \$1550 | \$1599 | \$1640 | \$1701 | \$1788 | \$1828 | \$1907 | \$2032 | \$2128 | \$2235 | \$2456 | \$2691 |
| | | OVERALL DIMENSIONS | | | SEAT DIMENSIONS | | | BACK DIMENSIONS | | | | | |
| | | W | D | H | W | D | H | W | H | | | | |
| | | | 49.5 | 22.5 | 19 | | | | | | | | |

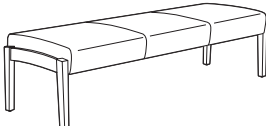
| DESCRIPTION | MODEL# | STANDARD FABRIC GRADES | | | | | | | | | | | |
|--|---------|------------------------|--------|--------|-----------------|--------|--------|-----------------|--------|--------|--------|--------|--------|
| | | COM | 2 | 3 | 4 | 5 | 6 | 7 | 8 | 9 | 10 | 11 | 12 |
|  <p>Three Seat Bench COM Yardage: 2.75 Freight Class: 250 Product Weight (lbs.): 61 Cubic Feet Per Carton: 28.75</p> | GC3653W | \$2129 | \$2199 | \$2255 | \$2339 | \$2458 | \$2514 | \$2622 | \$2794 | \$2926 | \$3073 | \$3377 | \$3700 |
| | | OVERALL DIMENSIONS | | | SEAT DIMENSIONS | | | BACK DIMENSIONS | | | | | |
| | | W | D | H | W | D | H | W | H | | | | |
| | | | 72.5 | 22.5 | 19 | | | | | | | | |

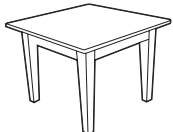
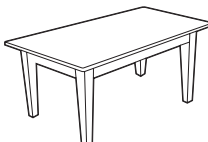
| TABLES | MODEL# | DIMENSIONS | FREIGHT CLASS | WT./LBS. | CUBIC FT. | LIST PRICE |
|--|-----------|--------------|--|----------|-----------|------------|
| | | D x W x H | | | | |
|  <p>Square End Table</p> | GC3664-LP | 22 x 22 x 17 | 250 | 22 | 6.75 | \$828 |
| | GC3664-HP | 22 x 22 x 17 | 250 | 22 | 6.75 | \$892 |
| | | | <ul style="list-style-type: none"> For a thermally fused top (LP), specify model GC3664-LP. For a high pressure laminate top, specify model GC3664-HP. | | | |
| | | | Coordinating edge and solid wood frame. | | | |
|  <p>Rectangular Coffee Table</p> | GC3665-LP | 42 x 21 x 15 | 250 | 35 | 11 | \$1065 |
| | GC3665-HP | 42 x 21 x 15 | 250 | 35 | 11 | \$1150 |
| | | | <ul style="list-style-type: none"> For a thermally fused top (LP), specify model GC3665-LP. For a high pressure laminate top, specify model GC3665-HP. | | | |
| | | | Coordinating edge and solid wood frame. | | | |

PRIMACARE HIGH TRAFFIC



model GC3631

FEATURES

- **Primacare HT is a rugged steel version of Primacare intended for High Traffic applications.**
- Single to five seater styles with or without center arms ensure a perfect configuration, no matter the size of the space
- Dining, Guest, Patient and Lounge units include metal mesh seat deck
- Contoured back with built-in lumbar support provides comfort and support
- Active weight capacity is **500 lbs. per seat** for standard and Bariatric steel frame models. For Lounge and Sofa models GC3676, GC3677, GC3678, GC3679, GC3676HB, GC3677HB, GC3678HB and GC3679HB, active weight capacity is 350 lbs.
- Wallsaver legs offer first contact to protect walls and chair back.
- Replaceable seat covers and replaceable and / or removable seat cushions.
- Easy grip forward extending armcap on models with arms.
- Waterfall cleanout between the seat and back cushions on all models.
- Seat and back are made from 3.5" Ultracell bio foam for added comfort.
- Frame is 1¼" x 2" rectangular 14 gauge steel with die cast zinc connectors and metal to metal fastening for unparalleled durability.
- Steel frame is available in Black (**BLK**), Platinum (**PLT**), Toast (**TOA**), Tungsten (**TUN**), Cappuccino (**T20**), Mocha (**J52**), and Kalua (**KAL**). Please specify at time of order placement.
- **Wood armcaps are standard** (excluding Lounge and Sofa models). Available in finishes that end with "M". Must be specified at time of order placement. Optional Self-skinned urethane (SSU) armcaps are available on select models in

Black (**BLK**), Platinum (**PLT**), Toast (**TOA**), Cappuccino (**T20**), Mocha (**J52**), and Kalua (**KAL**) at an upcharge. Refer to individual models for availability and pricing.

- Armcaps are securely fastened with metal to metal connectors which allow for field replacement if required.
- Anti-microbial and Anti-bacterial additive in top coat of wood finish.
- Lounge and Sofa models GC3676, GC3677, GC3678, GC3679, GC3676HB, GC3677HB, GC3678HB and GC3679HB are standard with **SSU legs** in Black (**BLK**), Platinum (**PLT**), Toast (**TOA**), Cappuccino (**T20**), Mocha (**J52**), or Kalua (**KAL**). Please specify. Wood legs are also available as an option in finishes ending with "M".
- Lounge and Sofa models GC3676, GC3677, GC3678, GC3679, GC3676HB, GC3677HB, GC3678HB and GC3679HB are standard with **fully upholstered arms**. Self-skinned urethane (SSU) armcaps are available in Black (**BLK**), Platinum (**PLT**), Toast (**TOA**), Cappuccino (**T20**), Mocha (**J52**), and Kalua (**KAL**) at an upcharge. **Add \$296**. Optional wood armcaps are also available at an upcharge. Available in finishes that end with "M". **Add \$296**
- Standard with Black Polypropylene/ Polyethylene non-marking Black glides. SSU and Wood legs are standard with white, non-marking glides.
- All **CA** models have closed upholstered arm cover at each arm position.
- Flex Back models feature a torsion control mechanism which allows the back to move in a soothing rocking motion.
- Select models are offered with wheels on the rear legs. These wheels allow for "tip and move" so the chair can be easily repositioned without lifting.
- Complementary tables are offered as part of this series in either high pressure or thermally fused laminate tops. Available in

all Globalcare standard laminates.

- High density Ultracell foam is standard.
- **Moisture Barrier (Seat Only) - Add \$85.00** list upcharge per seat.
- For Bariatric Models: GC3637, GC3637CA, GC3638, GC3638CA, GC3639, GC3639CA, GC3640, GC3640CA, GC3656, GC3656CA, GC3679 and GC3679HB - **Add \$131.00** list upcharge per seat.
- For Lounge Models: GC3641, GC3641CA, GC3642, GC3642CA, GC3643, GC3643CA, GC3676, GC3677, GC3678, GC3676HB, GC3677HB and GC3678HB - **Add \$127.00** list upcharge per seat.
- Complementary tables are offered as part of this series in either high pressure or thermally fused laminate tops. Available in all standard Globalcare laminate finishes.
- For Globalcare textiles and wood finish options, visit the web site at www.thinkglobalcare.com.
- This product can be upholstered in standard Global textiles if healthcare compliance is not required.
- For addition of a Fire Barrier Lining - **Add \$65.00** list upcharge per yard.
- Call Customer Care for **CAL133** approved textiles.

SUGGESTED APPLICATIONS

- Waiting Areas Dining Rooms
- Patient Rooms Lobbies
- Lounges Guest Seating
- Resident Rooms



GC3616

| COM | 2 | 3 | 4 | 5 | 6 | 7 | 8 | 9 | 10 | 11 | 12 |
|--------|--------|--------|--------|--------|--------|--------|--------|--------|--------|--------|--------|
| \$1040 | \$1075 | \$1103 | \$1146 | \$1205 | \$1227 | \$1280 | \$1378 | \$1427 | \$1519 | \$1645 | \$1645 |

| OVERALL DIMENSIONS | | | SEAT DIMENSIONS | | | BACK DIMENSIONS | |
|--------------------|----|------|-----------------|------|----|-----------------|------|
| W | D | H | W | D | H | W | H |
| 23 | 23 | 34.5 | 19 | 17.5 | 18 | 19 | 16.5 |

SSU armcap option - **Add \$67 list upcharge**

Dining Chair Open Arms
COM Yardage: 1.50
Freight Class: 250
Product Weight (lbs.): 40
Cubic Feet Per Carton: 13.25



GC3616CA

| COM | 2 | 3 | 4 | 5 | 6 | 7 | 8 | 9 | 10 | 11 | 12 |
|--------|--------|--------|--------|--------|--------|--------|--------|--------|--------|--------|--------|
| \$1190 | \$1236 | \$1273 | \$1330 | \$1409 | \$1439 | \$1509 | \$1640 | \$1706 | \$1827 | \$1996 | \$1996 |

| OVERALL DIMENSIONS | | | SEAT DIMENSIONS | | | BACK DIMENSIONS | |
|--------------------|----|------|-----------------|------|----|-----------------|------|
| W | D | H | W | D | H | W | H |
| 23 | 23 | 34.5 | 19 | 17.5 | 18 | 19 | 16.5 |

SSU armcap option - **Add \$67 list upcharge**

Dining Chair Closed Arms
COM Yardage: 2
Freight Class: 250
Product Weight (lbs.): 50
Cubic Feet Per Carton: 13.25

| DESCRIPTION | MODEL# | STANDARD FABRIC GRADES | | | | | | | | | | | |
|---|-----------------------------|--|--------|--------|-----------------|--------|--------|-----------------|--------|--------|--------|--------|--------|
| | | COM | 2 | 3 | 4 | 5 | 6 | 7 | 8 | 9 | 10 | 11 | 12 |
|  | GC3620 | \$1236 | \$1276 | \$1310 | \$1359 | \$1428 | \$1455 | \$1516 | \$1631 | \$1687 | \$1794 | \$1942 | \$1942 |
| | GC3620F Flex Back | \$1531 | \$1572 | \$1605 | \$1654 | \$1724 | \$1750 | \$1811 | \$1926 | \$1983 | \$2090 | \$2238 | \$2238 |
| | | OVERALL DIMENSIONS | | | SEAT DIMENSIONS | | | BACK DIMENSIONS | | | | | |
| | | W | D | H | W | D | H | W | H | | | | |
| | | 25 | 27 | 33 | 20.5 | 17.5 | 18 | 20.5 | 18 | | | | |
| <p>Low Back Single Seat Armchair Open Arms COM Yardage: 1.75 Freight Class: 250 Product Weight (lbs.): 46 Cubic Feet Per Carton: 17.50</p> | | SSU armcap option - Add \$67 list upcharge | | | | | | | | | | | |

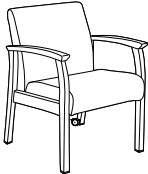
| DESCRIPTION | MODEL# | STANDARD FABRIC GRADES | | | | | | | | | | | |
|---|-----------------|--|--------|--------|-----------------|--------|--------|-----------------|--------|--------|--------|--------|--------|
| | | COM | 2 | 3 | 4 | 5 | 6 | 7 | 8 | 9 | 10 | 11 | 12 |
|  | GC3620RC | \$1363 | \$1403 | \$1436 | \$1485 | \$1555 | \$1581 | \$1642 | \$1757 | \$1814 | \$1921 | \$2069 | \$2069 |
| | | | | | | | | | | | | | |
| | | OVERALL DIMENSIONS | | | SEAT DIMENSIONS | | | BACK DIMENSIONS | | | | | |
| | | W | D | H | W | D | H | W | H | | | | |
| | | 25 | 29.5 | 33 | 20.5 | 17.5 | 18 | 20.5 | 18 | | | | |
| <p>Low Back Single Seat Armchair Open Arms, Rear Casters COM Yardage: 1.75 Freight Class: 250 Product Weight (lbs.): 46 Cubic Feet Per Carton: 17.50</p> | | SSU armcap option - Add \$67 list upcharge | | | | | | | | | | | |

| DESCRIPTION | MODEL# | STANDARD FABRIC GRADES | | | | | | | | | | | |
|---|-------------------------------|--|--------|--------|-----------------|--------|--------|-----------------|--------|--------|--------|--------|--------|
| | | COM | 2 | 3 | 4 | 5 | 6 | 7 | 8 | 9 | 10 | 11 | 12 |
|  | GC3620CA | \$1396 | \$1460 | \$1512 | \$1589 | \$1699 | \$1740 | \$1836 | \$2016 | \$2106 | \$2273 | \$2506 | \$2506 |
| | GC3620FCA Flex Back | \$1690 | \$1754 | \$1806 | \$1883 | \$1992 | \$2034 | \$2130 | \$2310 | \$2400 | \$2567 | \$2800 | \$2800 |
| | | OVERALL DIMENSIONS | | | SEAT DIMENSIONS | | | BACK DIMENSIONS | | | | | |
| | | W | D | H | W | D | H | W | H | | | | |
| | | 25 | 27 | 33 | 20.5 | 17.5 | 18 | 20.5 | 18 | | | | |
| <p>Low Back Single Seat Armchair Closed Arms COM Yardage: 2.75 Freight Class: 250 Product Weight (lbs.): 54 Cubic Feet Per Carton: 17.50</p> | | SSU armcap option - Add \$67 list upcharge | | | | | | | | | | | |

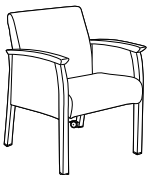
| DESCRIPTION | MODEL# | STANDARD FABRIC GRADES | | | | | | | | | | | |
|---|-------------------|--|--------|--------|-----------------|--------|--------|-----------------|--------|--------|--------|--------|--------|
| | | COM | 2 | 3 | 4 | 5 | 6 | 7 | 8 | 9 | 10 | 11 | 12 |
|  | GC3620CARC | \$1521 | \$1585 | \$1637 | \$1714 | \$1823 | \$1865 | \$1961 | \$2141 | \$2231 | \$2398 | \$2631 | \$2631 |
| | | | | | | | | | | | | | |
| | | OVERALL DIMENSIONS | | | SEAT DIMENSIONS | | | BACK DIMENSIONS | | | | | |
| | | W | D | H | W | D | H | W | H | | | | |
| | | 25 | 29.5 | 33 | 20.5 | 17.5 | 18 | 20.5 | 18 | | | | |
| <p>Low Back Single Seat Armchair Closed Arms, Rear Casters COM Yardage: 2.75 Freight Class: 250 Product Weight (lbs.): 54 Cubic Feet Per Carton: 17.50</p> | | SSU armcap option - Add \$67 list upcharge | | | | | | | | | | | |

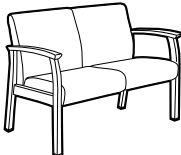
| DESCRIPTION | MODEL# | STANDARD FABRIC GRADES | | | | | | | | | | | |
|--|---------------|--|--------|--------|-----------------|--------|--------|-----------------|--------|--------|--------|--------|--------|
| | | COM | 2 | 3 | 4 | 5 | 6 | 7 | 8 | 9 | 10 | 11 | 12 |
|  | GC3621 | \$1992 | \$2068 | \$2129 | \$2220 | \$2350 | \$2399 | \$2512 | \$2724 | \$2830 | \$3029 | \$3304 | \$3304 |
| | | | | | | | | | | | | | |
| | | OVERALL DIMENSIONS | | | SEAT DIMENSIONS | | | BACK DIMENSIONS | | | | | |
| | | W | D | H | W | D | H | W | H | | | | |
| | | 45 | 27 | 33 | 40 | 17.5 | 18 | 40 | 18 | | | | |
| <p>Low Back Two Seat Chair No Center Arm, Open Arms COM Yardage: 3.25 Freight Class: 300 Product Weight (lbs.): 82 Cubic Feet Per Carton: 45.75</p> | | SSU armcap option - Add \$67 list upcharge | | | | | | | | | | | |

SEATING

PRIMACARE HT P

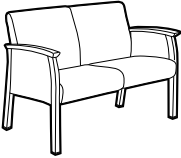
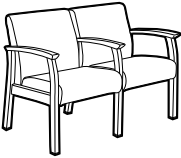
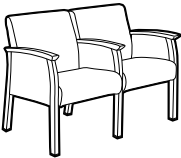
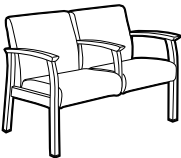
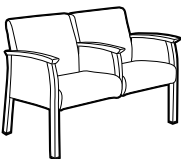
| DESCRIPTION | MODEL# | STANDARD FABRIC GRADES | | | | | | | | | | | |
|--|----------|---|--------|--------|-----------------|--------|--------|-----------------|--------|--------|--------|--------|--------|
| | | COM | 2 | 3 | 4 | 5 | 6 | 7 | 8 | 9 | 10 | 11 | 12 |
|  <p>Low Back Two Seat Chair No Center Arm, Closed Arms COM Yardage: 3.75 Freight Class: 250 Product Weight (lbs.): 94 Cubic Feet Per Carton: 45.75</p> | GC3621CA | \$2161 | \$2247 | \$2318 | \$2423 | \$2572 | \$2629 | \$2759 | \$3005 | \$3128 | \$3356 | \$3673 | \$3673 |
| | | OVERALL DIMENSIONS | | | SEAT DIMENSIONS | | | BACK DIMENSIONS | | | | | |
| | | W | D | H | W | D | H | W | H | | | | |
| | | | 45 | 27 | 33 | 40 | 17.5 | 18 | | 40 | 18 | | |
| | | SSU armcap option - Add \$67 list upcharge | | | | | | | | | | | |
|  <p>Low Back Two Seat Chair Full Center Arm, Open Arms COM Yardage: 3.25 Freight Class: 300 Product Weight (lbs.): 68 Cubic Feet Per Carton: 45.75</p> | GC3622 | \$2228 | \$2304 | \$2365 | \$2456 | \$2586 | \$2634 | \$2748 | \$2960 | \$3067 | \$3265 | \$3539 | \$3539 |
| | | OVERALL DIMENSIONS | | | SEAT DIMENSIONS | | | BACK DIMENSIONS | | | | | |
| | | W | D | H | W | D | H | W | H | | | | |
| | | | 46 | 27 | 33 | 20.5 | 17.5 | 18 | | 20.5 | 18 | | |
| | | SSU armcap option - Add \$101 list upcharge | | | | | | | | | | | |
|  <p>Low Back Two Seat Chair Full Center Arm, Closed Arms COM Yardage: 4.50 Freight Class: 300 Product Weight (lbs.): 78 Cubic Feet Per Carton: 45.75</p> | GC3622CA | \$2474 | \$2579 | \$2663 | \$2790 | \$2968 | \$3036 | \$3193 | \$3488 | \$3635 | \$3909 | \$4289 | \$4289 |
| | | OVERALL DIMENSIONS | | | SEAT DIMENSIONS | | | BACK DIMENSIONS | | | | | |
| | | W | D | H | W | D | H | W | H | | | | |
| | | | 46 | 27 | 33 | 20.5 | 17.5 | 18 | | 20.5 | 18 | | |
| | | SSU armcap option - Add \$101 list upcharge | | | | | | | | | | | |
|  <p>Low Back Two Seat Chair Half Center Arm, Open Arms COM Yardage: 3.25 Freight Class: 300 Product Weight (lbs.): 74 Cubic Feet Per Carton: 45.75</p> | GC3623 | \$2187 | \$2262 | \$2324 | \$2414 | \$2544 | \$2593 | \$2706 | \$2918 | \$3025 | \$3223 | \$3497 | \$3497 |
| | | OVERALL DIMENSIONS | | | SEAT DIMENSIONS | | | BACK DIMENSIONS | | | | | |
| | | W | D | H | W | D | H | W | H | | | | |
| | | | 46 | 27 | 33 | 20.5 | 17.5 | 18 | | 20.5 | 18 | | |
| | | SSU armcap option - Add \$101 list upcharge | | | | | | | | | | | |
|  <p>Low Back Two Seat Chair Half Center Arm, Closed Arms COM Yardage: 4.50 Freight Class: 300 Product Weight (lbs.): 84 Cubic Feet Per Carton: 45.75</p> | GC3623CA | \$2432 | \$2537 | \$2621 | \$2748 | \$2926 | \$2994 | \$3151 | \$3446 | \$3593 | \$3867 | \$4247 | \$4247 |
| | | OVERALL DIMENSIONS | | | SEAT DIMENSIONS | | | BACK DIMENSIONS | | | | | |
| | | W | D | H | W | D | H | W | H | | | | |
| | | | 46 | 27 | 33 | 20.5 | 17.5 | 18 | | 20.5 | 18 | | |
| | | SSU armcap option - Add \$101 list upcharge | | | | | | | | | | | |

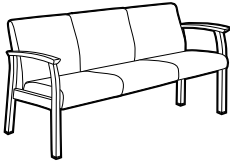
| DESCRIPTION | MODEL# | STANDARD FABRIC GRADES | | | | | | | | | | | |
|--|--------|------------------------|--------|--------|-----------------|--------|--------|-----------------|--------|--------|--------|--------|--------|
| | | COM | 2 | 3 | 4 | 5 | 6 | 7 | 8 | 9 | 10 | 11 | 12 |
|  <p>Low Back Three Seat Chair No Center Arm, Open Arms COM Yardage: 4.25 Freight Class: 300 Product Weight (lbs.): 90 Cubic Feet Per Carton: 65.25</p> | GC3624 | \$2602 | \$2677 | \$2738 | \$2829 | \$2959 | \$3008 | \$3121 | \$3333 | \$3440 | \$3638 | \$3913 | \$3913 |
| | | OVERALL DIMENSIONS | | | SEAT DIMENSIONS | | | BACK DIMENSIONS | | | | | |
| | | W | D | H | W | D | H | W | H | | | | |
| | | | 65 | 27 | 33 | 60 | 17.5 | 18 | 60 | 18 | | | |

SSU armcap option - Add \$67 list upcharge

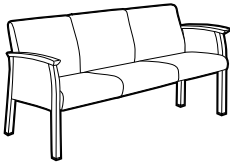
| DESCRIPTION | MODEL# | STANDARD FABRIC GRADES | | | | | | | | | | | |
|---|----------|------------------------|--------|--------|-----------------|--------|--------|-----------------|--------|--------|--------|--------|--------|
| | | COM | 2 | 3 | 4 | 5 | 6 | 7 | 8 | 9 | 10 | 11 | 12 |
|  <p>Low Back Three Seat Chair No Center Arm, Closed Arms COM Yardage: 5.25 Freight Class: 300 Product Weight (lbs.): 100 Cubic Feet Per Carton: 65.25</p> | GC3624CA | \$2738 | \$2861 | \$2960 | \$3107 | \$3315 | \$3395 | \$3578 | \$3921 | \$4094 | \$4412 | \$4857 | \$4857 |
| | | OVERALL DIMENSIONS | | | SEAT DIMENSIONS | | | BACK DIMENSIONS | | | | | |
| | | W | D | H | W | D | H | W | H | | | | |
| | | | 65 | 27 | 33 | 60 | 17.5 | 18 | 60 | 18 | | | |

SSU armcap option - Add \$67 list upcharge

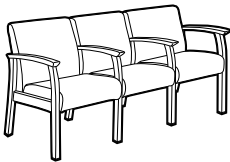
| DESCRIPTION | MODEL# | STANDARD FABRIC GRADES | | | | | | | | | | | |
|---|--------|------------------------|--------|--------|-----------------|--------|--------|-----------------|--------|--------|--------|--------|--------|
| | | COM | 2 | 3 | 4 | 5 | 6 | 7 | 8 | 9 | 10 | 11 | 12 |
|  <p>Low Back Three Seat Chair Full Center Arms, Open Arms COM Yardage: 4.75 Freight Class: 300 Product Weight (lbs.): 100 Cubic Feet Per Carton: 65.25</p> | GC3625 | \$3150 | \$3261 | \$3351 | \$3483 | \$3673 | \$3744 | \$3909 | \$4220 | \$4376 | \$4665 | \$5067 | \$5067 |
| | | OVERALL DIMENSIONS | | | SEAT DIMENSIONS | | | BACK DIMENSIONS | | | | | |
| | | W | D | H | W | D | H | W | H | | | | |
| | | | 69 | 27 | 33 | 20.5 | 17.5 | 18 | 20.5 | 18 | | | |

SSU armcap option - Add \$134 list upcharge

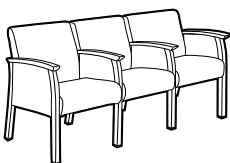
| DESCRIPTION | MODEL# | STANDARD FABRIC GRADES | | | | | | | | | | | |
|--|----------|------------------------|--------|--------|-----------------|--------|--------|-----------------|--------|--------|--------|--------|--------|
| | | COM | 2 | 3 | 4 | 5 | 6 | 7 | 8 | 9 | 10 | 11 | 12 |
|  <p>Low Back Three Seat Chair Full Center Arms, Closed Arms COM Yardage: 6.25 Freight Class: 300 Product Weight (lbs.): 110 Cubic Feet Per Carton: 65.25</p> | GC3625CA | \$3482 | \$3628 | \$3746 | \$3920 | \$4169 | \$4263 | \$4480 | \$4890 | \$5095 | \$5475 | \$6003 | \$6003 |
| | | OVERALL DIMENSIONS | | | SEAT DIMENSIONS | | | BACK DIMENSIONS | | | | | |
| | | W | D | H | W | D | H | W | H | | | | |
| | | | 69 | 27 | 33 | 20.5 | 17.5 | 18 | 20.5 | 18 | | | |

SSU armcap option - Add \$134 list upcharge

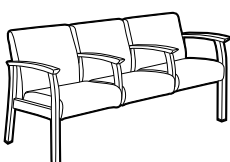
| DESCRIPTION | MODEL# | STANDARD FABRIC GRADES | | | | | | | | | | | |
|---|--------|------------------------|--------|--------|-----------------|--------|--------|-----------------|--------|--------|--------|--------|--------|
| | | COM | 2 | 3 | 4 | 5 | 6 | 7 | 8 | 9 | 10 | 11 | 12 |
|  <p>Low Back Three Seat Chair Half Center Arms, Open Arms COM Yardage: 4.75 Freight Class: 300 Product Weight (lbs.): 90 Cubic Feet Per Carton: 65.25</p> | GC3626 | \$3068 | \$3178 | \$3268 | \$3401 | \$3590 | \$3661 | \$3826 | \$4138 | \$4293 | \$4583 | \$4984 | \$4984 |
| | | OVERALL DIMENSIONS | | | SEAT DIMENSIONS | | | BACK DIMENSIONS | | | | | |
| | | W | D | H | W | D | H | W | H | | | | |
| | | | 69 | 27 | 33 | 20.5 | 17.5 | 18 | 20.5 | 18 | | | |

SSU armcap option - Add \$134 list upcharge

SEATING

PRIMACARE HT P

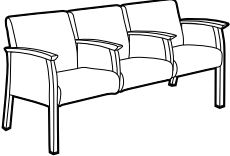
| DESCRIPTION | MODEL# | STANDARD FABRIC GRADES | | | | | | | | | | | |
|---|----------|--|--------|--------|------------------------|--------|--------|------------------------|--------|--------|--------|--------|--------|
| | | COM | 2 | 3 | 4 | 5 | 6 | 7 | 8 | 9 | 10 | 11 | 12 |
|  | GC3626CA | \$3400 | \$3545 | \$3663 | \$3839 | \$4086 | \$4182 | \$4399 | \$4807 | \$5012 | \$5393 | \$5921 | \$5921 |
| | | OVERALL DIMENSIONS | | | SEAT DIMENSIONS | | | BACK DIMENSIONS | | | | | |
| Low Back Three Seat Chair Half Center Arms, Closed Arms COM Yardage: 6.25 Freight Class: 300 Product Weight (lbs.): 100 Cubic Feet Per Carton: 65.25 | | 69 | 27 | 33 | 20.5 | 17.5 | 18 | 20.5 | 18 | | | | |
| | | SSU armcap option - Add \$134 list upcharge | | | | | | | | | | | |

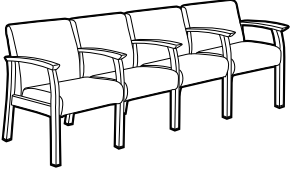
| | | | | | | | | | | | | | |
|---|--------|---|--------|--------|------------------------|--------|--------|------------------------|--------|--------|--------|--------|--------|
|  | GC3628 | COM | 2 | 3 | 4 | 5 | 6 | 7 | 8 | 9 | 10 | 11 | 12 |
| | | \$4501 | \$4641 | \$4754 | \$4922 | \$5161 | \$5252 | \$5460 | \$5852 | \$6050 | \$6415 | \$6922 | \$6922 |
| Low Back Four Seat Chair Full Center Arms, Open Arms COM Yardage: 6 Freight Class: 300 Product Weight (lbs.): 160 Cubic Feet Per Carton: 91.50 | | OVERALL DIMENSIONS | | | SEAT DIMENSIONS | | | BACK DIMENSIONS | | | | | |
| | | 93 | 27 | 33 | 20.5 | 17.5 | 18 | 20.5 | 18 | | | | |
| | | SSU armcap option - Add \$168 list upcharge | | | | | | | | | | | |
| | | • <i>Shipped RTA (Ready to Assemble) in 2 cartons</i> | | | | | | | | | | | |

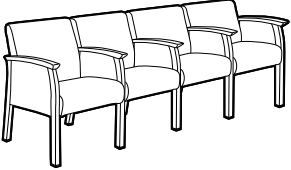
| | | | | | | | | | | | | | |
|---|----------|---|--------|--------|------------------------|--------|--------|------------------------|--------|--------|--------|--------|--------|
|  | GC3628CA | COM | 2 | 3 | 4 | 5 | 6 | 7 | 8 | 9 | 10 | 11 | 12 |
| | | \$4913 | \$5099 | \$5250 | \$5474 | \$5792 | \$5913 | \$6191 | \$6715 | \$6977 | \$7464 | \$8140 | \$8140 |
| Low Back Four Seat Chair Full Center Arms, Closed Arms COM Yardage: 8 Freight Class: 300 Product Weight (lbs.): 170 Cubic Feet Per Carton: 91.50 | | OVERALL DIMENSIONS | | | SEAT DIMENSIONS | | | BACK DIMENSIONS | | | | | |
| | | 93 | 27 | 33 | 20.5 | 17.5 | 18 | 20.5 | 18 | | | | |
| | | SSU armcap option - Add \$168 list upcharge | | | | | | | | | | | |
| | | • <i>Shipped RTA (Ready to Assemble) in 2 cartons</i> | | | | | | | | | | | |

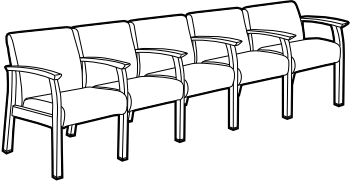
| | | | | | | | | | | | | | |
|--|--------|---|--------|--------|------------------------|--------|--------|------------------------|--------|--------|--------|--------|--------|
|  | GC3630 | COM | 2 | 3 | 4 | 5 | 6 | 7 | 8 | 9 | 10 | 11 | 12 |
| | | \$4943 | \$5118 | \$5259 | \$5470 | \$5768 | \$5881 | \$6142 | \$6633 | \$6879 | \$7335 | \$7970 | \$7970 |
| Low Back Five Seat Chair Full Center Arms, Open Arms COM Yardage: 7.50 Freight Class: 300 Product Weight (lbs.): 180 Cubic Feet Per Carton: 111 | | OVERALL DIMENSIONS | | | SEAT DIMENSIONS | | | BACK DIMENSIONS | | | | | |
| | | 115 | 27 | 33 | 20.5 | 17.5 | 18 | 20.5 | 18 | | | | |
| | | SSU armcap option - Add \$201 list upcharge | | | | | | | | | | | |
| | | • <i>Shipped RTA (Ready to Assemble) in 2 cartons</i> | | | | | | | | | | | |

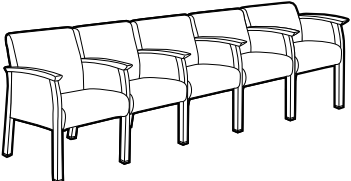
| | | | | | | | | | | | | | |
|--|----------|---|--------|--------|------------------------|--------|--------|------------------------|--------|--------|--------|--------|--------|
|  | GC3630CA | COM | 2 | 3 | 4 | 5 | 6 | 7 | 8 | 9 | 10 | 11 | 12 |
| | | \$5433 | \$5666 | \$5855 | \$6135 | \$6533 | \$6683 | \$7031 | \$7686 | \$8014 | \$8623 | \$9468 | \$9468 |
| Low Back Five Seat Chair Full Center Arms, Closed Arms COM Yardage: 10 Freight Class: 300 Product Weight (lbs.): 190 Cubic Feet Per Carton: 111 | | OVERALL DIMENSIONS | | | SEAT DIMENSIONS | | | BACK DIMENSIONS | | | | | |
| | | 115 | 27 | 33 | 20.5 | 17.5 | 18 | 20.5 | 18 | | | | |
| | | SSU armcap option - Add \$201 list upcharge | | | | | | | | | | | |
| | | • <i>Shipped RTA (Ready to Assemble) in 2 cartons</i> | | | | | | | | | | | |

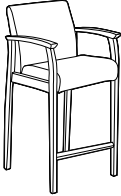
| DESCRIPTION | MODEL# | STANDARD FABRIC GRADES | | | | | | | | | | | |
|---|--------|---|----------|----------|------------------------|----------|----------|------------------------|----------|--------|--------|--------|--------|
| | | COM | 2 | 3 | 4 | 5 | 6 | 7 | 8 | 9 | 10 | 11 | 12 |
|  | GC3636 | \$1539 | \$1574 | \$1603 | \$1645 | \$1704 | \$1727 | \$1779 | \$1877 | \$1926 | \$2018 | \$2145 | \$2145 |
| | | OVERALL DIMENSIONS | | | SEAT DIMENSIONS | | | BACK DIMENSIONS | | | | | |
| | | W | D | H | W | D | H | W | H | | | | |
| | | 23 | 26 | 40.5 | 19 | 17.5 | 25.5 | 19 | 15.5 | | | | |
| <p>Low Back Single Seat Armchair Open Arms, Post Hip Surgery Height COM Yardage: 1.50 Freight Class: 250 Product Weight (lbs.): 67 Cubic Feet Per Carton: 20</p> | | SSU armcap option - Add \$67 list upcharge | | | | | | | | | | | |

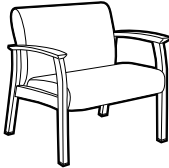
| DESCRIPTION | MODEL# | STANDARD FABRIC GRADES | | | | | | | | | | | |
|---|--------|---|----------|----------|------------------------|----------|----------|------------------------|----------|--------|--------|--------|--------|
| | | COM | 2 | 3 | 4 | 5 | 6 | 7 | 8 | 9 | 10 | 11 | 12 |
|  | GC3637 | \$1598 | \$1657 | \$1704 | \$1774 | \$1873 | \$1912 | \$1999 | \$2162 | \$2244 | \$2396 | \$2608 | \$2608 |
| | | OVERALL DIMENSIONS | | | SEAT DIMENSIONS | | | BACK DIMENSIONS | | | | | |
| | | W | D | H | W | D | H | W | H | | | | |
| | | 35 | 27 | 33 | 30 | 17.5 | 18 | 30 | 18 | | | | |
| <p>Bariatric Low Back Single Seat Armchair Open Arms COM Yardage: 2.50 Freight Class: 250 Product Weight (lbs.): 65 Cubic Feet Per Carton: 26.50</p> | | SSU armcap option - Add \$67 list upcharge | | | | | | | | | | | |
| | | • For users up to 500 lbs. | | | | | | | | | | | |

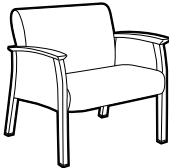
| DESCRIPTION | MODEL# | STANDARD FABRIC GRADES | | | | | | | | | | | |
|---|----------|---|----------|----------|------------------------|----------|----------|------------------------|----------|--------|--------|--------|--------|
| | | COM | 2 | 3 | 4 | 5 | 6 | 7 | 8 | 9 | 10 | 11 | 12 |
|  | GC3637CA | \$1759 | \$1841 | \$1907 | \$2005 | \$2144 | \$2197 | \$2318 | \$2548 | \$2662 | \$2875 | \$3171 | \$3171 |
| | | OVERALL DIMENSIONS | | | SEAT DIMENSIONS | | | BACK DIMENSIONS | | | | | |
| | | W | D | H | W | D | H | W | H | | | | |
| | | 35 | 27 | 33 | 30 | 17.5 | 18 | 30 | 18 | | | | |
| <p>Bariatric Low Back Single Seat Armchair Closed Arms COM Yardage: 3.50 Freight Class: 250 Product Weight (lbs.): 75 Cubic Feet Per Carton: 26.50</p> | | SSU armcap option - Add \$67 list upcharge | | | | | | | | | | | |
| | | • For users up to 500 lbs. | | | | | | | | | | | |

| DESCRIPTION | MODEL# | STANDARD FABRIC GRADES | | | | | | | | | | | |
|---|----------------------|---|----------|----------|------------------------|----------|----------|------------------------|----------|--------|--------|--------|--------|
| | | COM | 2 | 3 | 4 | 5 | 6 | 7 | 8 | 9 | 10 | 11 | 12 |
|  | GC3631 | \$1299 | \$1340 | \$1374 | \$1423 | \$1492 | \$1519 | \$1579 | \$1694 | \$1751 | \$1857 | \$2006 | \$2006 |
| | GC3631F Flex Back | \$1594 | \$1633 | \$1667 | \$1716 | \$1786 | \$1812 | \$1873 | \$1988 | \$2045 | \$2152 | \$2300 | \$2300 |
| | | OVERALL DIMENSIONS | | | SEAT DIMENSIONS | | | BACK DIMENSIONS | | | | | |
| | | W | D | H | W | D | H | W | H | | | | |
| | | 25 | 27 | 36.5 | 20.5 | 17.5 | 18 | 20.5 | 21 | | | | |
| <p>Medium Back Armchair Open Arms COM Yardage: 1.75 Freight Class: 250 Product Weight (lbs.): 48 Cubic Feet Per Carton: 20</p> | | SSU armcap option - Add \$67 list upcharge | | | | | | | | | | | |

| DESCRIPTION | MODEL# | STANDARD FABRIC GRADES | | | | | | | | | | | |
|---|----------|---|----------|----------|------------------------|----------|----------|------------------------|----------|--------|--------|--------|--------|
| | | COM | 2 | 3 | 4 | 5 | 6 | 7 | 8 | 9 | 10 | 11 | 12 |
|  | GC3631RC | \$1430 | \$1471 | \$1504 | \$1553 | \$1623 | \$1649 | \$1710 | \$1825 | \$1882 | \$1989 | \$2137 | \$2137 |
| | | OVERALL DIMENSIONS | | | SEAT DIMENSIONS | | | BACK DIMENSIONS | | | | | |
| | | W | D | H | W | D | H | W | H | | | | |
| | | 25 | 29.5 | 36.5 | 20.5 | 17.5 | 18 | 20.5 | 21 | | | | |
| <p>Medium Back Armchair Open Arms, Rear Casters COM Yardage: 1.75 Freight Class: 250 Product Weight (lbs.): 48 Cubic Feet Per Carton: 23</p> | | SSU armcap option - Add \$67 list upcharge | | | | | | | | | | | |

SEATING

PRIMACARE HT P

| DESCRIPTION | MODEL# | STANDARD FABRIC GRADES | | | | | | | | | | | | |
|---|-------------------------------|------------------------|----------|------------------------|----------|----------|------------------------|----------|----------|--------|--------|--------|--------|--|
| | | COM | 2 | 3 | 4 | 5 | 6 | 7 | 8 | 9 | 10 | 11 | 12 | |
|  <p>Medium Back Armchair Closed Arms COM Yardage: 2.75 Freight Class: 250 Product Weight (lbs.): 56 Cubic Feet Per Carton: 20</p> | GC3631CA | \$1483 | \$1547 | \$1599 | \$1677 | \$1785 | \$1827 | \$1922 | \$2103 | \$2193 | \$2360 | \$2593 | \$2593 | |
| | GC3631FCA Flex Back | \$1767 | \$1831 | \$1883 | \$1960 | \$2069 | \$2111 | \$2207 | \$2387 | \$2477 | \$2644 | \$2877 | \$2877 | |
| | OVERALL DIMENSIONS | | | SEAT DIMENSIONS | | | BACK DIMENSIONS | | | | | | | |
| | | W | D | H | W | D | H | W | H | | | | | |
| | | 25 | 27 | 36.5 | 20.5 | 17.5 | 18 | 20.5 | 21 | | | | | |

SSU armcap option - Add \$67 list upcharge

| DESCRIPTION | MODEL# | STANDARD FABRIC GRADES | | | | | | | | | | | |
|---|---------------------------|------------------------|----------|------------------------|----------|----------|------------------------|----------|----------|----------|--------|--------|--------|
| | | COM | 2 | 3 | 4 | 5 | 6 | 7 | 8 | 9 | 10 | 11 | 12 |
|  <p>Medium Back Armchair Closed Arms, Rear Casters COM Yardage: 2.75 Freight Class: 250 Product Weight (lbs.): 56 Cubic Feet Per Carton: 23</p> | GC3631CARC | \$1612 | \$1676 | \$1728 | \$1805 | \$1914 | \$1956 | \$2052 | \$2232 | \$2322 | \$2489 | \$2722 | \$2722 |
| | OVERALL DIMENSIONS | | | SEAT DIMENSIONS | | | BACK DIMENSIONS | | | | | | |
| | | | W | D | H | W | D | H | W | H | | | |
| | | 25 | 29.5 | 36.5 | 20.5 | 17.5 | 18 | 20.5 | 21 | | | | |

SSU armcap option - Add \$67 list upcharge

| DESCRIPTION | MODEL# | STANDARD FABRIC GRADES | | | | | | | | | | | |
|---|-----------------------------|------------------------|----------|------------------------|----------|----------|------------------------|----------|----------|--------|--------|--------|--------|
| | | COM | 2 | 3 | 4 | 5 | 6 | 7 | 8 | 9 | 10 | 11 | 12 |
|  <p>High Back Armchair Open Arms, Split Back COM Yardage: 2.25 Freight Class: 250 Product Weight (lbs.): 58 Cubic Feet Per Carton: 27.50</p> | GC3632 | \$1449 | \$1501 | \$1544 | \$1607 | \$1697 | \$1730 | \$1808 | \$1956 | \$2030 | \$2167 | \$2357 | \$2357 |
| | GC3632F Flex Back | \$1735 | \$1787 | \$1830 | \$1893 | \$1982 | \$2016 | \$2094 | \$2242 | \$2315 | \$2452 | \$2643 | \$2643 |
| | OVERALL DIMENSIONS | | | SEAT DIMENSIONS | | | BACK DIMENSIONS | | | | | | |
| | | W | D | H | W | D | H | W | H | | | | |
| | | 25 | 27 | 48.5 | 20.5 | 17.5 | 18 | 20.5 | 30 | | | | |

Fold away headrest.
SSU armcap option - Add \$67 list upcharge

| DESCRIPTION | MODEL# | STANDARD FABRIC GRADES | | | | | | | | | | | |
|--|---------------------------|------------------------|----------|------------------------|----------|----------|------------------------|----------|----------|----------|--------|--------|--------|
| | | COM | 2 | 3 | 4 | 5 | 6 | 7 | 8 | 9 | 10 | 11 | 12 |
|  <p>High Back Armchair Open Arms, Split Back, Rear Casters COM Yardage: 2.25 Freight Class: 250 Product Weight (lbs.): 58 Cubic Feet Per Carton: 27.50</p> | GC3632RC | \$1579 | \$1631 | \$1674 | \$1737 | \$1826 | \$1860 | \$1938 | \$2086 | \$2159 | \$2296 | \$2487 | \$2487 |
| | OVERALL DIMENSIONS | | | SEAT DIMENSIONS | | | BACK DIMENSIONS | | | | | | |
| | | | W | D | H | W | D | H | W | H | | | |
| | | 25 | 29.5 | 48.5 | 20.5 | 17.5 | 18 | 20.5 | 30 | | | | |

Fold away headrest.
SSU armcap option - Add \$67 list upcharge

| DESCRIPTION | MODEL# | STANDARD FABRIC GRADES | | | | | | | | | | | |
|---|-------------------------------|------------------------|----------|------------------------|----------|----------|------------------------|----------|----------|--------|--------|--------|--------|
| | | COM | 2 | 3 | 4 | 5 | 6 | 7 | 8 | 9 | 10 | 11 | 12 |
|  <p>High Back Armchair Closed Arms, Split Back COM Yardage: 3 Freight Class: 250 Product Weight (lbs.): 66 Cubic Feet Per Carton: 27.50</p> | GC3632CA | \$1638 | \$1708 | \$1764 | \$1849 | \$1968 | \$2013 | \$2118 | \$2314 | \$2412 | \$2595 | \$2849 | \$2849 |
| | GC3632FCA Flex Back | \$1916 | \$1985 | \$2043 | \$2127 | \$2246 | \$2291 | \$2396 | \$2592 | \$2690 | \$2873 | \$3127 | \$3127 |
| | OVERALL DIMENSIONS | | | SEAT DIMENSIONS | | | BACK DIMENSIONS | | | | | | |
| | | W | D | H | W | D | H | W | H | | | | |
| | | 25 | 27 | 48.5 | 20.5 | 17.5 | 18 | 20.5 | 30 | | | | |

Fold away headrest.
SSU armcap option - Add \$67 list upcharge

| DESCRIPTION | MODEL# | STANDARD FABRIC GRADES | | | | | | | | | | | |
|---|------------|------------------------------------|--------|--------|---------------------------------|--------|--------|-------------------------------|--------|--------|--------|--------|--------|
| | | COM | 2 | 3 | 4 | 5 | 6 | 7 | 8 | 9 | 10 | 11 | 12 |
|  High Back Armchair Closed Arms, Split Back, Rear Casters COM Yardage: 3 Freight Class: 250 Product Weight (lbs.): 66 Cubic Feet Per Carton: 27.50 | GC3632CARC | \$1766 | \$1836 | \$1893 | \$1977 | \$2096 | \$2141 | \$2246 | \$2442 | \$2541 | \$2723 | \$2977 | \$2977 |
| | | OVERALL DIMENSIONS W D H | | | SEAT DIMENSIONS W D H | | | BACK DIMENSIONS W H | | | | | |
| | | 25 | 29.5 | 48.5 | 20.5 | 17.5 | 18 | 20.5 | 30 | | | | |

Fold away headrest.
SSU armcap option - **Add \$67 list upcharge**

| DESCRIPTION | MODEL# | STANDARD FABRIC GRADES | | | | | | | | | | | |
|--|--------|------------------------------------|--------|--------|---------------------------------|--------|--------|-------------------------------|--------|--------|--------|--------|--------|
| | | COM | 2 | 3 | 4 | 5 | 6 | 7 | 8 | 9 | 10 | 11 | 12 |
|  Bariatric Medium Back Armchair Open Arms COM Yardage: 2.75 Freight Class: 250 Product Weight (lbs.): 70 Cubic Feet Per Carton: 30.50 | GC3638 | \$1662 | \$1726 | \$1778 | \$1855 | \$1964 | \$2006 | \$2102 | \$2282 | \$2372 | \$2539 | \$2772 | \$2772 |
| | | OVERALL DIMENSIONS W D H | | | SEAT DIMENSIONS W D H | | | BACK DIMENSIONS W H | | | | | |
| | | 35 | 27 | 36.5 | 30 | 17.5 | 18 | 30 | 21 | | | | |

SSU armcap option - **Add \$67 list upcharge**

- For users up to 500 lbs.

| DESCRIPTION | MODEL# | STANDARD FABRIC GRADES | | | | | | | | | | | |
|---|----------|------------------------------------|--------|--------|---------------------------------|--------|--------|-------------------------------|--------|--------|--------|--------|--------|
| | | COM | 2 | 3 | 4 | 5 | 6 | 7 | 8 | 9 | 10 | 11 | 12 |
|  Bariatric Medium Back Armchair Closed Arms COM Yardage: 3.75 Freight Class: 250 Product Weight (lbs.): 80 Cubic Feet Per Carton: 30.50 | GC3638CA | \$1846 | \$1933 | \$2004 | \$2109 | \$2258 | \$2314 | \$2445 | \$2690 | \$2814 | \$3041 | \$3358 | \$3358 |
| | | OVERALL DIMENSIONS W D H | | | SEAT DIMENSIONS W D H | | | BACK DIMENSIONS W H | | | | | |
| | | 35 | 27 | 36.5 | 30 | 17.5 | 18 | 30 | 21 | | | | |

SSU armcap option - **Add \$67 list upcharge**

- For users up to 500 lbs.

| DESCRIPTION | MODEL# | STANDARD FABRIC GRADES | | | | | | | | | | | |
|--|--------|------------------------------------|--------|--------|---------------------------------|--------|--------|-------------------------------|--------|--------|--------|--------|--------|
| | | COM | 2 | 3 | 4 | 5 | 6 | 7 | 8 | 9 | 10 | 11 | 12 |
|  Bariatric High Back Armchair Open Arms, Split Back COM Yardage: 3.75 Freight Class: 250 Product Weight (lbs.): 70 Cubic Feet Per Carton: 30.75 | GC3639 | \$1846 | \$1933 | \$2004 | \$2109 | \$2258 | \$2314 | \$2445 | \$2690 | \$2814 | \$3041 | \$3358 | \$3358 |
| | | OVERALL DIMENSIONS W D H | | | SEAT DIMENSIONS W D H | | | BACK DIMENSIONS W H | | | | | |
| | | 35 | 27 | 48.5 | 30 | 17.5 | 18 | 30 | 30 | | | | |

Fold away headrest.
SSU armcap option - **Add \$67 list upcharge**

- For users up to 500 lbs.

| DESCRIPTION | MODEL# | STANDARD FABRIC GRADES | | | | | | | | | | | |
|--|----------|------------------------------------|--------|--------|---------------------------------|--------|--------|-------------------------------|--------|--------|--------|--------|--------|
| | | COM | 2 | 3 | 4 | 5 | 6 | 7 | 8 | 9 | 10 | 11 | 12 |
|  Bariatric High Back Armchair Closed Arms, Split Back COM Yardage: 4.75 Freight Class: 250 Product Weight (lbs.): 78 Cubic Feet Per Carton: 30.75 | GC3639CA | \$2028 | \$2139 | \$2228 | \$2361 | \$2550 | \$2621 | \$2788 | \$3098 | \$3254 | \$3543 | \$3944 | \$3944 |
| | | OVERALL DIMENSIONS W D H | | | SEAT DIMENSIONS W D H | | | BACK DIMENSIONS W H | | | | | |
| | | 35 | 27 | 48.5 | 30 | 17.5 | 18 | 30 | 30 | | | | |

Fold away headrest.
SSU armcap option - **Add \$67 list upcharge**

- For users up to 500 lbs.

SEATING

PRIMACARE HT P

| DESCRIPTION | MODEL# | STANDARD FABRIC GRADES | | | | | | | | | | | |
|---|---------------------------|------------------------|--------|------------------------|--------|--------|------------------------|--------|--------|--------|--------|--------|--------|
| | | COM | 2 | 3 | 4 | 5 | 6 | 7 | 8 | 9 | 10 | 11 | 12 |
|  | GC3655 | \$1352 | \$1410 | \$1457 | \$1527 | \$1627 | \$1665 | \$1752 | \$1915 | \$1997 | \$2149 | \$2361 | \$2361 |
| | | GC3655F Flex Back | \$1643 | \$1700 | \$1748 | \$1819 | \$1918 | \$1956 | \$2043 | \$2206 | \$2288 | \$2440 | \$2652 |
| | OVERALL DIMENSIONS | | | SEAT DIMENSIONS | | | BACK DIMENSIONS | | | | | | |
| | | W | D | H | W | D | H | W | H | | | | |
| | | 25 | 27 | 48.5 | 20.5 | 17.5 | 18 | 20.5 | 30 | | | | |

High Back Armchair Open Arms
COM Yardage: 2.50
Freight Class: 250
Product Weight (lbs.): 58
Cubic Feet Per Carton: 27.50

SSU armcap option - Add \$67 list upcharge

| DESCRIPTION | MODEL# | STANDARD FABRIC GRADES | | | | | | | | | | | |
|---|----------|---------------------------|--------|--------|------------------------|--------|--------|------------------------|--------|--------|--------|--------|--------|
| | | COM | 2 | 3 | 4 | 5 | 6 | 7 | 8 | 9 | 10 | 11 | 12 |
|  | GC3655RC | \$1482 | \$1540 | \$1587 | \$1658 | \$1757 | \$1795 | \$1882 | \$2045 | \$2127 | \$2279 | \$2491 | \$2491 |
| | | OVERALL DIMENSIONS | | | SEAT DIMENSIONS | | | BACK DIMENSIONS | | | | | |
| | | | W | D | H | W | D | H | W | H | | | |
| | | 25 | 29.5 | 48.5 | 20.5 | 17.5 | 18 | 20.5 | 30 | | | | |

High Back Armchair Open Arms, Rear Casters
COM Yardage: 2.50
Freight Class: 250
Product Weight (lbs.): 58
Cubic Feet Per Carton: 27.50

SSU armcap option - Add \$67 list upcharge

| DESCRIPTION | MODEL# | STANDARD FABRIC GRADES | | | | | | | | | | | |
|--|---------------------------|------------------------|--------|------------------------|--------|--------|------------------------|--------|--------|--------|--------|--------|--------|
| | | COM | 2 | 3 | 4 | 5 | 6 | 7 | 8 | 9 | 10 | 11 | 12 |
|  | GC3655CA | \$1541 | \$1616 | \$1678 | \$1769 | \$1898 | \$1947 | \$2060 | \$2273 | \$2379 | \$2577 | \$2852 | \$2852 |
| | | GC3655FCA Flex Back | \$1819 | \$1896 | \$1956 | \$2048 | \$2177 | \$2226 | \$2339 | \$2552 | \$2658 | \$2856 | \$3131 |
| | OVERALL DIMENSIONS | | | SEAT DIMENSIONS | | | BACK DIMENSIONS | | | | | | |
| | | W | D | H | W | D | H | W | H | | | | |
| | | 25 | 27 | 48.5 | 20.5 | 17.5 | 18 | 20.5 | 30 | | | | |

High Back Armchair Closed Arms
COM Yardage: 3.25
Freight Class: 250
Product Weight (lbs.): 66
Cubic Feet Per Carton: 27.50

SSU armcap option - Add \$67 list upcharge

| DESCRIPTION | MODEL# | STANDARD FABRIC GRADES | | | | | | | | | | | |
|---|------------|---------------------------|--------|--------|------------------------|--------|--------|------------------------|--------|--------|--------|--------|--------|
| | | COM | 2 | 3 | 4 | 5 | 6 | 7 | 8 | 9 | 10 | 11 | 12 |
|  | GC3655CARC | \$1668 | \$1744 | \$1805 | \$1897 | \$2026 | \$2075 | \$2188 | \$2401 | \$2507 | \$2705 | \$2980 | \$2980 |
| | | OVERALL DIMENSIONS | | | SEAT DIMENSIONS | | | BACK DIMENSIONS | | | | | |
| | | | W | D | H | W | D | H | W | H | | | |
| | | 25 | 27 | 48.5 | 20.5 | 17.5 | 18 | 20.5 | 30 | | | | |

High Back Armchair Closed Arms, Rear Casters
COM Yardage: 3.25
Freight Class: 250
Product Weight (lbs.): 66
Cubic Feet Per Carton: 27.50

SSU armcap option - Add \$67 list upcharge

| DESCRIPTION | MODEL# | STANDARD FABRIC GRADES | | | | | | | | | | | |
|---|--------|---------------------------|--------|--------|------------------------|--------|--------|------------------------|--------|--------|--------|--------|--------|
| | | COM | 2 | 3 | 4 | 5 | 6 | 7 | 8 | 9 | 10 | 11 | 12 |
|  | GC3656 | \$1713 | \$1795 | \$1861 | \$1959 | \$2098 | \$2151 | \$2272 | \$2502 | \$2617 | \$2829 | \$3125 | \$3125 |
| | | OVERALL DIMENSIONS | | | SEAT DIMENSIONS | | | BACK DIMENSIONS | | | | | |
| | | | W | D | H | W | D | H | W | H | | | |
| | | 35 | 27 | 48.5 | 30 | 17.5 | 18 | 30 | 30 | | | | |

Bariatric High Back Armchair Open Arms
COM Yardage: 3.50
Freight Class: 250
Product Weight (lbs.): 70
Cubic Feet Per Carton: 30.75

SSU armcap option - Add \$67 list upcharge

• For users up to 500 lbs.

| DESCRIPTION | MODEL# | STANDARD FABRIC GRADES | | | | | | | | | | | |
|---|----------|------------------------|--------|--------|-----------------|--------|--------|-----------------|--------|--------|--------|--------|--------|
| | | COM | 2 | 3 | 4 | 5 | 6 | 7 | 8 | 9 | 10 | 11 | 12 |
|  | GC3656CA | \$1896 | \$2001 | \$2085 | \$2212 | \$2390 | \$2458 | \$2615 | \$2910 | \$3057 | \$3331 | \$3711 | \$3711 |
| | | OVERALL DIMENSIONS | | | SEAT DIMENSIONS | | | BACK DIMENSIONS | | | | | |
| | | | W | D | H | W | D | H | W | H | | | |
| | | | 35 | 27 | 48.5 | 30 | 17.5 | 18 | 30 | 30 | | | |

Bariatric High Back Armchair Closed Arms
 COM Yardage: 4.50
 Freight Class: 250
 Product Weight (lbs.): 78
 Cubic Feet Per Carton: 30.75

SSU armcap option - **Add \$67 list upcharge**

- For users up to 500 lbs.

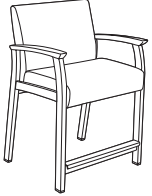
| DESCRIPTION | MODEL# | STANDARD FABRIC GRADES | | | | | | | | | | | |
|---|--------|------------------------|------|------|-----------------|------|------|-----------------|------|------|------|------|------|
| | | COM | 2 | 3 | 4 | 5 | 6 | 7 | 8 | 9 | 10 | 11 | 12 |
|  | GC3657 | 2132 | 2167 | 2196 | 2238 | 2297 | 2320 | 2372 | 2470 | 2519 | 2611 | 2738 | 2894 |
| | | OVERALL DIMENSIONS | | | SEAT DIMENSIONS | | | BACK DIMENSIONS | | | | | |
| | | | W | D | H | W | D | H | W | H | | | |
| | | | 28 | 25 | 41 | 24 | 17.5 | 26 | 24 | 15.5 | | | |

24" Hip Armchair Open Arms. Integrated footrest.
 COM Yardage: 1.50
 Freight Class: 250
 Product Weight (lbs.): 78
 Cubic Feet Per Carton: 20

SSU armcap option - **Add \$67 list upcharge**

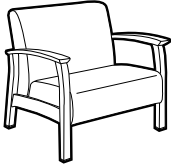
| DESCRIPTION | MODEL# | STANDARD FABRIC GRADES | | | | | | | | | | | |
|--|--------|------------------------|--------|--------|-----------------|--------|--------|-----------------|--------|--------|--------|--------|--------|
| | | COM | 2 | 3 | 4 | 5 | 6 | 7 | 8 | 9 | 10 | 11 | 12 |
|  | GC3640 | \$2063 | \$2139 | \$2200 | \$2291 | \$2421 | \$2470 | \$2583 | \$2795 | \$2901 | \$3100 | \$3375 | \$3375 |
| | | OVERALL DIMENSIONS | | | SEAT DIMENSIONS | | | BACK DIMENSIONS | | | | | |
| | | | W | D | H | W | D | H | W | H | | | |
| | | | 40 | 32 | 33 | 36 | 20 | 17.25 | 36 | 16 | | | |

Bariatric Lounge Chair Open Arms
 COM Yardage: 3.25
 Freight Class: 250
 Product Weight (lbs.): 100
 Cubic Feet Per Carton: 49.50

SSU armcap option - **Add \$80 list upcharge**

- For users up to 500 lbs.

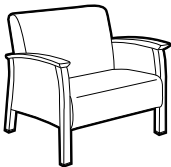
| DESCRIPTION | MODEL# | STANDARD FABRIC GRADES | | | | | | | | | | | |
|---|----------|------------------------|--------|--------|-----------------|--------|--------|-----------------|--------|--------|--------|--------|--------|
| | | COM | 2 | 3 | 4 | 5 | 6 | 7 | 8 | 9 | 10 | 11 | 12 |
|  | GC3640CA | \$2211 | \$2344 | \$2453 | \$2614 | \$2843 | \$2930 | \$3129 | \$3505 | \$3695 | \$4045 | \$4531 | \$4531 |
| | | OVERALL DIMENSIONS | | | SEAT DIMENSIONS | | | BACK DIMENSIONS | | | | | |
| | | | W | D | H | W | D | H | W | H | | | |
| | | | 40 | 32 | 33 | 36 | 20 | 17.25 | 36 | 16 | | | |

Bariatric Lounge Chair Closed Arms
 COM Yardage: 5.75
 Freight Class: 250
 Product Weight (lbs.): 110
 Cubic Feet Per Carton: 49.50

SSU armcap option - **Add \$80 list upcharge**

- For users up to 500 lbs.

| DESCRIPTION | MODEL# | STANDARD FABRIC GRADES | | | | | | | | | | | |
|---|--------|------------------------|--------|--------|-----------------|--------|--------|-----------------|--------|--------|--------|--------|--------|
| | | COM | 2 | 3 | 4 | 5 | 6 | 7 | 8 | 9 | 10 | 11 | 12 |
|  | GC3641 | \$1664 | \$1722 | \$1769 | \$1839 | \$1938 | \$1977 | \$2063 | \$2226 | \$2309 | \$2460 | \$2673 | \$2673 |
| | | OVERALL DIMENSIONS | | | SEAT DIMENSIONS | | | BACK DIMENSIONS | | | | | |
| | | | W | D | H | W | D | H | W | H | | | |
| | | | 29 | 32 | 33 | 23.5 | 20 | 17.25 | 23 | 16 | | | |

Lounge Chair Open Arms
 COM Yardage: 2.50
 Freight Class: 300
 Product Weight (lbs.): 48
 Cubic Feet Per Carton: 29.50

SSU armcap option - **Add \$80 list upcharge**

SEATING

PRIMACARE HT P

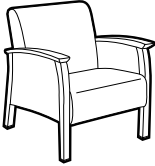
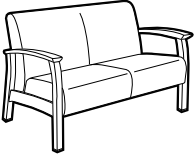
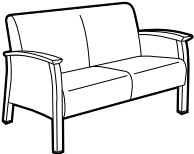
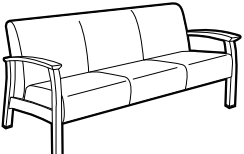
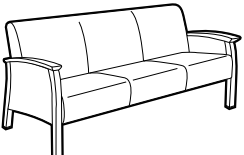
| DESCRIPTION | MODEL# | STANDARD FABRIC GRADES | | | | | | | | | | | |
|--|----------|------------------------|--|--------|-----------------|--------|--------|-----------------|--------|--------|--------|--------|--------|
| | | COM | 2 | 3 | 4 | 5 | 6 | 7 | 8 | 9 | 10 | 11 | 12 |
|  <p>Lounge Chair Closed Arms COM Yardage: 3.75 Freight Class: 300 Product Weight (lbs.): 56 Cubic Feet Per Carton: 29.50</p> | GC3641CA | \$1841 | \$1927 | \$1999 | \$2103 | \$2252 | \$2309 | \$2440 | \$2685 | \$2808 | \$3036 | \$3353 | \$3353 |
| | | OVERALL DIMENSIONS | | | SEAT DIMENSIONS | | | BACK DIMENSIONS | | | | | |
| | | W | D | H | W | D | H | W | H | | | | |
| | | | 29 | 32 | 33 | 23.5 | 20 | 17.25 | 23 | 16 | | | |
| | | | SSU armcap option - Add \$80 list upcharge | | | | | | | | | | |
|  <p>Two Seat Sofa Open Arms COM Yardage: 4 Freight Class: 250 Product Weight (lbs.): 105 Cubic Feet Per Carton: 49.50</p> | GC3642 | \$2340 | \$2433 | \$2508 | \$2621 | \$2780 | \$2841 | \$2980 | \$3241 | \$3373 | \$3616 | \$3954 | \$3954 |
| | | OVERALL DIMENSIONS | | | SEAT DIMENSIONS | | | BACK DIMENSIONS | | | | | |
| | | W | D | H | W | D | H | W | H | | | | |
| | | | 52 | 32 | 33 | 48 | 20 | 17.25 | 48 | 16 | | | |
| | | | SSU armcap option - Add \$80 list upcharge | | | | | | | | | | |
|  <p>Two Seat Sofa Closed Arms COM Yardage: 5.50 Freight Class: 250 Product Weight (lbs.): 115 Cubic Feet Per Carton: 49.50</p> | GC3642CA | \$2554 | \$2683 | \$2786 | \$2941 | \$3160 | \$3242 | \$3434 | \$3794 | \$3975 | \$4309 | \$4774 | \$4774 |
| | | OVERALL DIMENSIONS | | | SEAT DIMENSIONS | | | BACK DIMENSIONS | | | | | |
| | | W | D | H | W | D | H | W | H | | | | |
| | | | 52 | 32 | 33 | 48 | 20 | 17.25 | 48 | 16 | | | |
| | | | SSU armcap option - Add \$80 list upcharge | | | | | | | | | | |
|  <p>Three Seat Sofa Open Arms COM Yardage: 6.25 Freight Class: 250 Product Weight (lbs.): 140 Cubic Feet Per Carton: 69.50</p> | GC3643 | \$3318 | \$3464 | \$3582 | \$3756 | \$4005 | \$4099 | \$4316 | \$4726 | \$4931 | \$5311 | \$5840 | \$5840 |
| | | OVERALL DIMENSIONS | | | SEAT DIMENSIONS | | | BACK DIMENSIONS | | | | | |
| | | W | D | H | W | D | H | W | H | | | | |
| | | | 75 | 32 | 33 | 71 | 20 | 17.25 | 71 | 16 | | | |
| | | | SSU armcap option - Add \$80 list upcharge | | | | | | | | | | |
|  <p>Three Seat Sofa Closed Arms COM Yardage: 7.50 Freight Class: 250 Product Weight (lbs.): 150 Cubic Feet Per Carton: 69.50</p> | GC3643CA | \$3495 | \$3669 | \$3811 | \$4021 | \$4318 | \$4432 | \$4693 | \$5184 | \$5430 | \$5886 | \$6520 | \$6520 |
| | | OVERALL DIMENSIONS | | | SEAT DIMENSIONS | | | BACK DIMENSIONS | | | | | |
| | | W | D | H | W | D | H | W | H | | | | |
| | | | 75 | 32 | 33 | 71 | 20 | 17.25 | 71 | 16 | | | |
| | | | SSU armcap option - Add \$80 list upcharge | | | | | | | | | | |

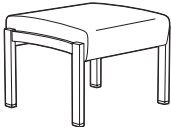
| DESCRIPTION | MODEL# | STANDARD FABRIC GRADES | | | | | | | | | | | |
|---|--------|------------------------|--------|--------|-----------------|--------|--------|-----------------|--------|--------|--------|--------|--------|
| | | COM | 2 | 3 | 4 | 5 | 6 | 7 | 8 | 9 | 10 | 11 | 12 |
|  <p>Single Seat Bench COM Yardage: 1.25 Freight Class: 250 Product Weight (lbs.): 31 Cubic Feet Per Carton: 10.25</p> | GC3651 | \$1127 | \$1158 | \$1184 | \$1222 | \$1276 | \$1302 | \$1351 | \$1429 | \$1489 | \$1556 | \$1694 | \$1841 |
| | | OVERALL DIMENSIONS | | | SEAT DIMENSIONS | | | BACK DIMENSIONS | | | | | |
| | | W | D | H | W | D | H | W | H | | | | |
| | | 26.5 | 22.5 | 19 | | | | | | | | | |

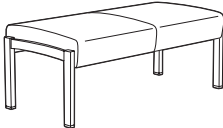
|  <p>Two Seat Bench COM Yardage: 2 Freight Class: 250 Product Weight (lbs.): 48 Cubic Feet Per Carton: 20.25</p> | GC3652 | \$1779 | \$1829 | \$1870 | \$1931 | \$2018 | \$2058 | \$2137 | \$2262 | \$2358 | \$2465 | \$2686 | \$2921 |
|---|--------|--------------------|--------|--------|-----------------|--------|--------|-----------------|--------|--------|--------|--------|--------|
| | | OVERALL DIMENSIONS | | | SEAT DIMENSIONS | | | BACK DIMENSIONS | | | | | |
| | | W | D | H | W | D | H | W | H | | | | |
| | | 49.5 | 22.5 | 19 | | | | | | | | | |

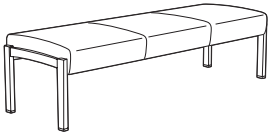
|  <p>Three Seat Bench COM Yardage: 2.75 Freight Class: 250 Product Weight (lbs.): 66 Cubic Feet Per Carton: 28.75</p> | GC3653 | \$2431 | \$2500 | \$2556 | \$2640 | \$2759 | \$2815 | \$2923 | \$3095 | \$3227 | \$3375 | \$3678 | \$4001 |
|---|--------|--------------------|--------|--------|-----------------|--------|--------|-----------------|--------|--------|--------|--------|--------|
| | | OVERALL DIMENSIONS | | | SEAT DIMENSIONS | | | BACK DIMENSIONS | | | | | |
| | | W | D | H | W | D | H | W | H | | | | |
| | | 72.5 | 22.5 | 19 | | | | | | | | | |

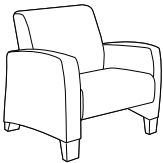
|  <p>Lounge Chair Fully Upholstered Arms, SSU legs COM Yardage: 6.25 Freight Class: 250 Product Weight (lbs.): 80 Cubic Feet Per Carton: 29.50</p> | GC3676 | \$1395 | \$1541 | \$1659 | \$1834 | \$2082 | \$2177 | \$2394 | \$2803 | \$3008 | \$3389 | \$3917 | \$3917 | | |
|---|--------|--------------------|--------|--------|-----------------|--------|--------|-----------------|--------|--------|--------|--------|--------|--|--|
| | | OVERALL DIMENSIONS | | | SEAT DIMENSIONS | | | BACK DIMENSIONS | | | | | | | |
| | | W | D | H | W | D | H | W | H | | | | | | |
| | | 32.5 | 32 | 33 | 23 | 20 | 17.25 | 23 | 16 | | | | | | |

Wood legs optional - No charge.
SSU or Wood armcap option - **Add \$296 list upcharge**

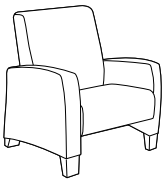
|  <p>High Back Lounge Chair Fully Upholstered Arms, SSU legs COM Yardage: 6.50 Freight Class: 250 Product Weight (lbs.): 90 Cubic Feet Per Carton: 29.50</p> | GC3676HB | \$1428 | \$1599 | \$1737 | \$1942 | \$2232 | \$2343 | \$2597 | \$3076 | \$3315 | \$3761 | \$4379 | \$4379 | | |
|---|----------|--------------------|--------|--------|-----------------|--------|--------|-----------------|--------|--------|--------|--------|--------|--|--|
| | | OVERALL DIMENSIONS | | | SEAT DIMENSIONS | | | BACK DIMENSIONS | | | | | | | |
| | | W | D | H | W | D | H | W | H | | | | | | |
| | | 32.5 | 32 | 36 | 23 | 20 | 17.25 | 23 | 19 | | | | | | |

Wood legs optional - No charge.
SSU or Wood armcap option - **Add \$296 list upcharge**

SEATING

PRIMACARE HT P

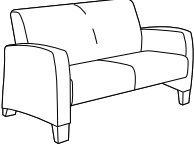
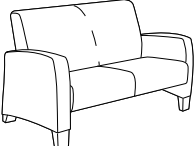
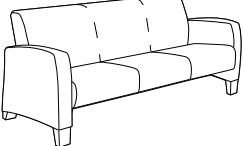
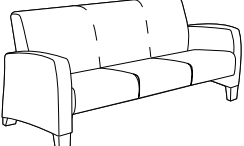
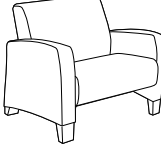
| DESCRIPTION | MODEL# | STANDARD FABRIC GRADES | | | | | | | | | | | |
|---|----------|---|--------|--------|------------------------|--------|--------|------------------------|--------|--------|--------|--------|--------|
| | | COM | 2 | 3 | 4 | 5 | 6 | 7 | 8 | 9 | 10 | 11 | 12 |
|  <p>Two Seat Sofa Fully Upholstered Arms, SSU legs COM Yardage: 7.50 Freight Class: 300 Product Weight (lbs.): 105 Cubic Feet Per Carton: 56.25</p> | GC3677 | \$2018 | \$2193 | \$2334 | \$2544 | \$2842 | \$2956 | \$3216 | \$3707 | \$3954 | \$4409 | \$5044 | \$5044 |
| | | OVERALL DIMENSIONS | | | SEAT DIMENSIONS | | | BACK DIMENSIONS | | | | | |
| | | W | D | H | W | D | H | W | H | | | | |
| | | | 55.5 | 32 | 33 | 48 | 20 | 17.25 | 48 | 16 | | | |
| | | Wood legs optional - No charge. SSU or Wood armcap option - Add \$296 list upcharge | | | | | | | | | | | |
|  <p>High Back Two Seat Sofa Fully Upholstered Arms, SSU legs COM Yardage: 7.75 Freight Class: 250 Product Weight (lbs.): 115 Cubic Feet Per Carton: 56.25</p> | GC3677HB | \$2105 | \$2309 | \$2473 | \$2718 | \$3064 | \$3195 | \$3499 | \$4070 | \$4355 | \$4886 | \$5623 | \$5623 |
| | | OVERALL DIMENSIONS | | | SEAT DIMENSIONS | | | BACK DIMENSIONS | | | | | |
| | | W | D | H | W | D | H | W | H | | | | |
| | | | 55.5 | 32 | 36 | 48 | 20 | 17.25 | 48 | 19 | | | |
| | | Wood legs optional - No charge. SSU or Wood armcap option - Add \$296 list upcharge | | | | | | | | | | | |
|  <p>Three Seat Sofa Fully Upholstered Arms, SSU legs COM Yardage: 9 Freight Class: 250 Product Weight (lbs.): 142 Cubic Feet Per Carton: 69.50</p> | GC3678 | \$2776 | \$2986 | \$3155 | \$3408 | \$3766 | \$3901 | \$4214 | \$4803 | \$5098 | \$5647 | \$6407 | \$6407 |
| | | OVERALL DIMENSIONS | | | SEAT DIMENSIONS | | | BACK DIMENSIONS | | | | | |
| | | W | D | H | W | D | H | W | H | | | | |
| | | | 75 | 32 | 33 | 71 | 20 | 17.25 | 71 | 16 | | | |
| | | Wood legs optional - No charge. SSU or Wood armcap option - Add \$296 list upcharge | | | | | | | | | | | |
|  <p>High Back Three Seat Sofa Fully Upholstered Arms, SSU legs COM Yardage: 9.25 Freight Class: 250 Product Weight (lbs.): 150 Cubic Feet Per Carton: 69.50</p> | GC3678HB | \$2917 | \$3160 | \$3356 | \$3648 | \$4061 | \$4218 | \$4580 | \$5261 | \$5602 | \$6236 | \$7116 | \$7116 |
| | | OVERALL DIMENSIONS | | | SEAT DIMENSIONS | | | BACK DIMENSIONS | | | | | |
| | | W | D | H | W | D | H | W | H | | | | |
| | | | 75 | 32 | 36 | 71 | 20 | 17.25 | 71 | 19 | | | |
| | | Wood legs optional - No charge. SSU or Wood armcap option - Add \$296 list upcharge | | | | | | | | | | | |
|  <p>Bariatric Lounge Chair Fully Upholstered Arms, SSU legs COM Yardage: 6.50 Freight Class: 250 Product Weight (lbs.): 90 Cubic Feet Per Carton: 37.75</p> | GC3679 | \$2012 | \$2164 | \$2286 | \$2469 | \$2727 | \$2825 | \$3051 | \$3476 | \$3689 | \$4085 | \$4635 | \$4635 |
| | | OVERALL DIMENSIONS | | | SEAT DIMENSIONS | | | BACK DIMENSIONS | | | | | |
| | | W | D | H | W | D | H | W | H | | | | |
| | | | 42 | 32 | 33 | 36 | 20 | 17.25 | 36 | 16 | | | |
| | | Wood legs optional - No charge. SSU or Wood armcap option - Add \$296 list upcharge | | | | | | | | | | | |
| | | • For users up to 500 lbs. | | | | | | | | | | | |

| DESCRIPTION | MODEL# | STANDARD FABRIC GRADES | | | | | | | | | | | |
|-------------|--------|------------------------|---|---|---|---|---|---|---|---|----|----|----|
| | | COM | 2 | 3 | 4 | 5 | 6 | 7 | 8 | 9 | 10 | 11 | 12 |

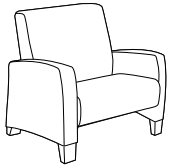

GC3679HB

| | | | | | | | | | | | |
|--------|--------|--------|--------|--------|--------|--------|--------|--------|--------|--------|--------|
| \$2075 | \$2252 | \$2395 | \$2608 | \$2910 | \$3024 | \$3288 | \$3786 | \$4034 | \$4497 | \$5139 | \$5139 |
|--------|--------|--------|--------|--------|--------|--------|--------|--------|--------|--------|--------|

| OVERALL DIMENSIONS | | | SEAT DIMENSIONS | | | BACK DIMENSIONS | |
|--------------------|----|----|-----------------|----|-------|-----------------|----|
| W | D | H | W | D | H | W | H |
| 42 | 32 | 36 | 36 | 20 | 17.25 | 36 | 19 |

High Back Bariatric Lounge Chair Fully Upholstered Arms, SSU legs
 COM Yardage: 6.75
 Freight Class: 250
 Product Weight (lbs.): 95
 Cubic Feet Per Carton: 37.75

Wood legs optional - No charge.
 SSU or Wood armcap option - **Add \$296 list upcharge**
 • For users up to 500 lbs.

| TABLES | MODEL# | DIMENSIONS | FREIGHT CLASS | WT/LBS. | CUBIC FT. | LIST PRICE |
|--------|--------|------------|---------------|---------|-----------|------------|
|--------|--------|------------|---------------|---------|-----------|------------|

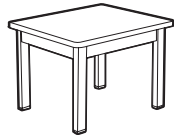

Rectangular End Table

| | | | | | |
|-----------|--------------|-----|----|------|--------------|
| GC3661-LP | 20 x 24 x 17 | 250 | 35 | 10.5 | \$805 |
| GC3661-HP | 20 x 24 x 17 | 250 | 35 | 10.5 | \$890 |

- For a thermally fused top (LP), specify model GC3661-LP.
- For a high pressure laminate top, specify model GC3661-HP.

Coordinating edge. 1.25" x 2" rectangular metal frame.

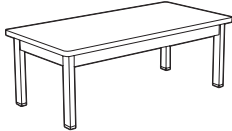

Rectangular Coffee Table

| | | | | | |
|-----------|--------------|-----|----|----|---------------|
| GC3662-LP | 42 x 21 x 15 | 250 | 52 | 14 | \$1022 |
| GC3662-HP | 42 x 21 x 15 | 250 | 52 | 14 | \$1133 |

- For a thermally fused top (LP), specify model GC3662-LP.
- For a high pressure laminate top, specify model GC3662-HP.

Coordinating edge. 1.25" x 2" rectangular metal frame.

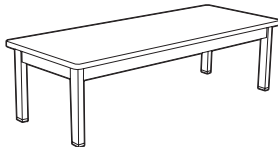

Rectangular Coffee Table

| | | | | | |
|-----------|--------------|-----|----|------|---------------|
| GC3663-LP | 54 x 21 x 15 | 250 | 58 | 17.5 | \$1252 |
| GC3663-HP | 54 x 21 x 15 | 250 | 58 | 17.5 | \$1376 |

- For a thermally fused top (LP), specify model GC3662-LP.
- For a high pressure laminate top, specify model GC3662-HP.

Coordinating edge. 1.25" x 2" rectangular metal frame.

PRIMACARE MODULAR



FEATURES

- **Wood leg and arm frames** are available in finishes that end with "M".
- **Steel frame** is available in Black (BLK), Toast (TOA), Platinum (PLT), Tungsten (TUN), Cappuccino (T20), Mocha (J52), and Kalua (KAL). Please specify at time of order placement.
- **Wood armcaps are standard.** Available in finishes that end with "M". Must be specified at time of order placement. Optional Self-skinned urethane armcaps are available on select models in Black (BLK), Toast (TOA), Platinum (PLT), Cappuccino (T20), Mocha (J52), and Kalua (KAL) at an upcharge. Refer to individual models for availability and pricing.
- **Modular tops:** For linking application, only Patient High Back, Patient Medium Back and Guest Low Back tops are available. **Top units** are complete with frame and cushions. Leg and arm frames are ordered separately according to the desired specification.
- All CA models have closed upholstered arm cover at each arm position.
- High density Ultracell foam is standard. **Moisture Barrier (Seat Only) - Add \$85.00** list upcharge per seat. For Bariatric Models: - **Add \$131.00** list upcharge per seat.
- **Left and Right Position Reference** is determined based on being seated in the chair.
- As an option, seams can be sealed to prevent penetration of fluids through the stitching. Contact Customer Service for approved textiles and for upcharges, as cost varies by model.
- For Globalcare textiles and wood finish options, visit the web site at www.thinkglobalcare.com.
- This product can be upholstered in standard Global textiles if healthcare compliance is not required.
- For addition of a Fire Barrier Lining - **Add \$65.00** list upcharge per yard.
- Call Customer Care for **CAL133** approved textiles.

SUGGESTED APPLICATIONS

- Waiting Areas
- Dining Rooms
- Patient Rooms
- Lobbies
- Lounges
- Guest Seating
- Resident Rooms

MODULAR TABLES

Modular Tables offered with Wood or Metal legs. 1" thick table tops are available in thermally fused laminate (L) and high pressure laminate (H). Please select the appropriate model number for the finish you prefer.

Note: Modular tables are shipped KD (knock down) as per the published cube and weight.

Wooden Leg Tables:

Thermally Fused Laminate (L)

- (ACJ) Absolute Acajou
- (ASN) Asian Night
- (AWC) Avant Cherry
- (AWH) Avant Honey
- (BRC) Brushed Cobalt
- (CSJ) Constellation Java
- (DES) Dark Espresso
- (HGT) Hayden Grey
- (QTM) Quartered Mahogany
- (SKC) Shaker Cherry
- (TFW) Tiger Fruitwood
- (TMA) Tiger Mahogany
- (TMP) Tiger Maple
- (TWL) Tiger Walnut
- (WHT) White
- (WHC) White Chocolate
- (WCR) Winter Cherry

High Pressure Laminate (H)

- (W357) Avant Cherry
- (W356) Avant Honey
- (BCH) Brushed Cobalt
- (CJH) Constellation Java
- (W142) Dark Espresso
- (CMB) Clear Maple
- (EMB) Empire Mahogany
- (W313) Quartered Mahogany
- (SKB) Shaker Cherry
- (W821) Tiger Fruitwood
- (W822) Tiger Mahogany
- (W820) Tiger Maple
- (W819) Tiger Walnut
- (S645) White
- (W149) Winter Cherry

Metal Leg and Frame Finishes:

Available in Black (BLK), Tungsten (TUN) Toast (TOA), Platinum (PLT), Cappuccino (T20), Mocha (J52), and Kalua (KAL).

SHIPPING INFORMATION:

Product components and parts will be shipped KD (knock down). The weight and cubes are indicated with each item KD. They will not be assembled.

Assembled With Drawing

Product orders that are part of a linked application may require a combination of complete units and components for build up to achieve the limitless configurations that are possible. GLOBALcare will provide ASSEMBLED WITH DRAWING service for these orders under the following conditions:

1. Detailed drawing clearly indicating:
 - The layout and location of each model number being ordered (see sample following).
 - If multiple textiles are used. Color code textiles used on each seat, back and closed arms.
 2. GLOBALcare will carton ASSEMBLED WITH DRAWING orders to a maximum of 3 regular seats, which is the largest carton available.
 3. GLOBALcare reserves the right to determine the best method of assembly based on the information provided with the order.
- Always call out components as if seated in the chairs!

PACKAGE 1 - Primacare HT

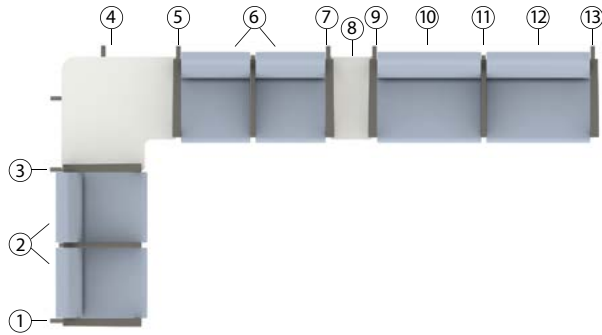

Always call out components as if seated in the chairs.

| Item | Description | Qty. | Model # | Dimensions (D x W x H) | Ydg. | Frts. Class | Wt. Lbs. | Cu. Ft. | List Price | Ext. Price |
|--------|---|------|------------|------------------------|------|-------------|----------|---------|------------|------------|
| 1 | Right End Frame with Right Armcap | 1 | GC3620RA | 27 x 2.5 x 26.5 | -- | 125 | 10 | 1.40 | \$377 | \$377 |
| 2, 6 | Guest Low Back Two Seat Top w/Half Center Arm | 2 | GC3623TOP | 25 x 42 x 19 | 3.25 | 300 | 68 | 45.75 | \$1765 | \$3530 |
| 3, 7 | Seat to Table Center Linking Frame w/Left Armcap | 2 | GC3622TLA | 27 x 2.5 x 26.5 | -- | 125 | 10 | 1.40 | \$410 | \$820 |
| 4 | Right Corner Table | 1 | GC3671R-HP | 33 x 33 x 17 | -- | 125 | 45 | 6 | \$966 | \$966 |
| 5, 9 | Seat to Table Center Linking Frame w/Right Armcap | 2 | GC3622TRA | 27 x 2.5 x 26.5 | -- | 125 | 10 | 1.40 | \$410 | \$820 |
| 8 | Narrow Center Table | 1 | GC3673-HP | 23.87 x 12 x 5.5 | -- | 100 | 18 | 2.10 | \$527 | \$527 |
| 10, 12 | Bariatric Top, Guest Low Back | 2 | GC3637TOP | 25 x 30 x 19 | 2.50 | 250 | 53 | 26.50 | \$1112 | \$2224 |
| 11 | Seat to Seat Center Linking Frame w/Narrow Armcap | 1 | GC3622LA | 27 x 2.5 x 26.5 | -- | 125 | 10 | 1.40 | \$420 | \$420 |
| 13 | Left End Frame with Left Armcap | 1 | GC3620LA | 27 x 2.5 x 26.5 | -- | 125 | 10 | 1.40 | \$377 | \$377 |

PACKAGE TOTAL

\$10,061

(*Please Note: List Prices shown are for the standard Grade 2 vinyl/standard finishes.)

PACKAGE 2 - Primacare HT

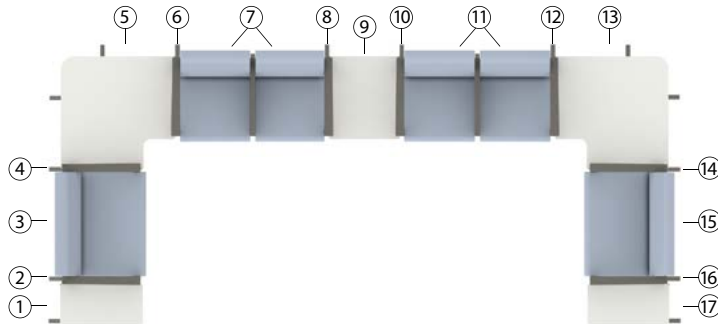

Always call out components as if seated in the chairs.

| Item | Description | Qty. | Model # | Dimensions (D x W x H) | Ydg. | Frts. Class | Wt. Lbs. | Cu. Ft. | List Price | Ext. Price |
|--------------|---|------|------------|------------------------|------|-------------|----------|---------|------------|------------|
| 1 | Narrow Right End Table | 1 | GC3675R-HP | 23.87 x 12 x 17 | -- | 100 | 18 | 2.10 | \$774 | \$774 |
| 2, 6, 10, 14 | Seat to Table Center Linking Frame w/Right Armcap | 4 | GC3622TRA | 27 x 2.5 x 26.5 | -- | 125 | 10 | 1.40 | \$410 | \$1640 |
| 3, 15 | Guest Low Back Bariatric Top | 2 | GC3637TOP | 25 x 30 x 19 | 2.50 | 250 | 53 | 26.50 | \$1112 | \$2224 |
| 4, 8, 12, 16 | Seat to Table Center Linking Frame w/Left Armcap | 4 | GC3622TLA | 27 x 2.5 x 26.5 | -- | 125 | 10 | 1.40 | \$410 | \$1640 |
| 5 | Right Corner Table | 1 | GC3671R-HP | 33 x 33 x 17 | -- | 125 | 45 | 6 | \$966 | \$966 |
| 7, 11 | Guest Low Back Two Seat Top w/Half Center Arm | 2 | GC3623TOP | 25 x 42 x 19 | 3.25 | 300 | 68 | 45.75 | \$1765 | \$3530 |
| 9 | Regular Center Table | 1 | GC3672-HP | 23.87 x 20.25 x 17 | -- | 150 | 20 | 3.40 | \$542 | \$542 |
| 13 | Left Corner Table | 1 | GC3671L-HP | 33 x 33 x 17 | -- | 125 | 45 | 6 | \$966 | \$966 |
| 17 | Narrow Left End Table | 1 | GC3675L-HP | 23.87 x 12 x 17 | -- | 100 | 18 | 2.10 | \$774 | \$774 |

PACKAGE TOTAL

\$13,056

(*Please Note: List Prices shown are for the standard Grade 2 vinyl/standard finishes.)

PACKAGE 3 - Primacare Wood

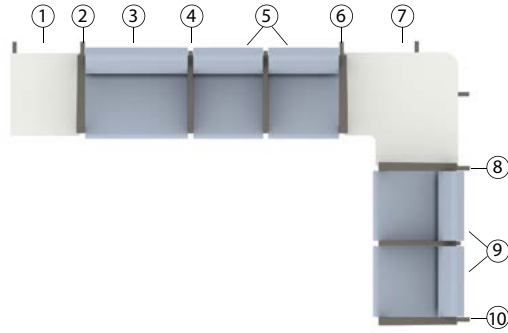











Always call out components as if seated in the chairs.

| Item | Description | Qty. | Model # | Dimensions (D x W x H) | Ydg. | Frts. Class | Wt. Lbs. | Cu. Ft. | List Price | Ext. Price |
|------|---|------|-------------|------------------------|------|-------------|----------|---------|------------|------------|
| 1 | Right End Run Table | 1 | GC3674WR-LP | 23.87 x 20.25 x 17 | -- | 100 | 32 | 3.40 | \$712 | \$712 |
| 2, 8 | Seat to Table Center Linking Frame w/Right Armcap | 2 | GC3622WTRA | 27 x 2.5 x 26.5 | -- | 150 | 8 | 1.40 | \$301 | \$602 |
| 3 | Guest Low Back Bariatric Top | 1 | GC3637TOP | 25 x 30 x 19 | 2.50 | 250 | 53 | 26.50 | \$1112 | \$1112 |
| 4 | Seat to Seat Center Linking Frame w/Narrow Armcap | 1 | GC3622WLA | 27 x 2.5 x 26.5 | -- | 150 | 8 | 1.40 | \$279 | \$279 |
| 5, 9 | Guest Low Back Two Seat Top w/Half Center Arm | 2 | GC3623WTOP | 25 x 42 x 19 | 3.25 | 300 | 68 | 45.75 | \$1570 | \$3140 |
| 6 | Seat to Table Center Linking Frame w/Left Armcap | 1 | GC3622WTLA | 27 x 2.5 x 26.5 | -- | 150 | 8 | 1.40 | \$301 | \$301 |
| 7 | Left Corner Table | 1 | GC3671WL-HP | 33 x 33 x 17 | -- | 100 | 54 | 6 | \$914 | \$914 |
| 10 | Left End Frame w/Left Armcap | 1 | GC3620WLA | 23 x 2 x 26 | -- | 125 | 10 | 1.40 | \$268 | \$268 |

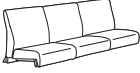
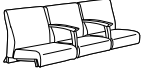



















PACKAGE TOTAL

(*Please Note: List Prices shown are for the standard Grade 2 vinyl/standard finishes.)





























\$7269

| | SINGLE SEAT | BARIATRIC | TWO SEATER, NO CENTER ARMS | TWO SEATER, CENTER ARM | THREE SEATER, NO CENTER ARMS | THREE SEATER 2 ARMS |
|--------------------------|---|---|---|---|---|---|
| Modular Top Units | GC3620TOP | GC3637TOP | GC3621TOP | GC3623TOP GC3623WTOP | GC3624TOP | GC3626TOP GC3626WTOP |
| Guest Seating |  |  |  |  |  |  |
| | | GC3638TOP | | GC3623CATOP GC3623WCATOP | | GC3626CATOP GC3626WCATOP |
| | |  | |  | |  |
| Patient Seating | GC3631TOP | GC3656TOP | | | | |
| |  |  | | | | |
| | GC3655TOP | | | | | |
| |  | | | | | |

Leg/Arm Frames Wood Frame: Wood arm standard | Metal Frame: Wood arm standard

| | LEFT, OPEN | RIGHT, OPEN | LEFT, CLOSED | RIGHT, CLOSED |
|---|---|---|--|--|
| Metal (HT), End | GC3620LA  | GC3620RA  | GC3620LCA  | GC3620RCA  |
| Wood, End | GC3620WLA  | GC3620WRA  | GC3620WLCA  | GC3620WRCA  |
| Metal (HT), Center | GC3622LA  | | GC3622LCA  | |
| Wood, Center | GC3622WLA  | | GC3622WLCA  | |
| Metal (HT), Center Table Linking | GC3622TLA  | GC3622TRA  | GC3622TLCA  | GC3622TRCA  |
| Wood, Center Table Linking | GC3622WTLA  | GC3622WTRA  | GC3622WTLCA  | GC3622WTRCA  |

Center = link both sides

| | | | | |
|--|--|---|---|--|
| Armcaps <i>For Field Replacement</i> | LEFT, SSU GC3616SSULACAP  | RIGHT, SSU GC3616SSURACAP  | LEFT, WOOD GC3616WLACAP  | RIGHT, WOOD GC3616WRACAP  |
| Dining Chair | | | | |
| Guest and Patient | GC3620SSULACAP  | GC3620SSURACAP  | GC3620WLACAP  | GC3620WRACAP  |
| Narrow, Center | CENTER GC3622SSULACAP  | | CENTER GC3622WLACAP  | |
| Lounge | LEFT, SSU GC3641SSULACAP  | RIGHT, SSU GC3641SSURACAP  | LEFT, WOOD GC3641WLACAP  | RIGHT, WOOD GC3641WRACAP  |
| Modular Tables | | | | |
| Corner | LEFT, METAL GC3671L-HP GC3671L-LP  | RIGHT, METAL GC3671R-HP GC3671R-LP  | LEFT, WOOD GC3671WL-HP GC3671WL-LP  | RIGHT, WOOD GC3671WR-HP GC3671WR-LP  |
| Center | GC3672-HP GC3672-LP  | | | |
| Narrow Center | GC3673-HP GC3673-LP  | | | |
| End | GC3674L-HP GC3674L-LP  | GC3674R-HP GC3674R-LP  | GC3674WL-HP GC3674WL-LP  | GC3674WR-HP GC3674WR-LP  |
| Narrow End | GC3675L-HP GC3675L-LP  | GC3675R-HP GC3675R-LP  | GC3675WL-HP GC3675WL-LP  | GC3675WR-HP GC3675WR-LP  |

DESCRIPTION

MODEL#

STANDARD FABRIC GRADES

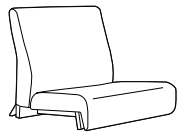

GC3620TOP

| COM | 2 | 3 | 4 | 5 | 6 | 7 | 8 | 9 | 10 | 11 | 12 |
|-------|-------|-------|-------|-------|-------|-------|--------|--------|--------|--------|--------|
| \$657 | \$697 | \$730 | \$779 | \$849 | \$875 | \$936 | \$1051 | \$1108 | \$1215 | \$1363 | \$1363 |

OVERALL DIMENSIONS

W D H

SEAT DIMENSIONS

W D H

BACK DIMENSIONS

W H

| | | | | | | | |
|------|----|----|------|------|----|------|----|
| 20.5 | 25 | 19 | 20.5 | 17.5 | -- | 20.5 | 15 |
|------|----|----|------|------|----|------|----|

Low Back Guest Single Seat Top

COM Yardage: 1.75
 Freight Class: 250
 Product Weight (lbs.): 36
 Cubic Feet Per Carton: 10

Single frame guest top unit complete with 1 low back cushion and 1 seat cushion.

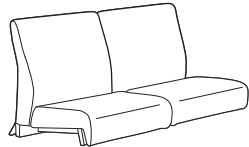

GC3621TOP

| COM | 2 | 3 | 4 | 5 | 6 | 7 | 8 | 9 | 10 | 11 | 12 |
|--------|--------|--------|--------|--------|--------|--------|--------|--------|--------|--------|--------|
| \$1462 | \$1537 | \$1599 | \$1690 | \$1819 | \$1868 | \$1981 | \$2194 | \$2300 | \$2498 | \$2773 | \$2773 |

OVERALL DIMENSIONS

W D H

SEAT DIMENSIONS

W D H

BACK DIMENSIONS

W H

| | | | | | | | |
|----|----|----|----|------|----|----|----|
| 40 | 25 | 19 | 40 | 17.5 | -- | 40 | 15 |
|----|----|----|----|------|----|----|----|

Low Back Guest 2 Seat Top No Center Arm

COM Yardage: 3.25
 Freight Class: 300
 Product Weight (lbs.): 72
 Cubic Feet Per Carton: 45.75

Double frame guest top unit complete with 2 low back cushions and 2 seat cushions.

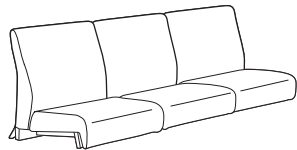

GC3624TOP

| COM | 2 | 3 | 4 | 5 | 6 | 7 | 8 | 9 | 10 | 11 | 12 |
|--------|--------|--------|--------|--------|--------|--------|--------|--------|--------|--------|--------|
| \$2204 | \$2303 | \$2383 | \$2502 | \$2671 | \$2735 | \$2883 | \$3161 | \$3301 | \$3559 | \$3919 | \$3919 |

OVERALL DIMENSIONS

W D H

SEAT DIMENSIONS

W D H

BACK DIMENSIONS

W H

| | | | | | | | |
|----|----|----|----|------|----|----|----|
| 60 | 25 | 19 | 60 | 17.5 | -- | 60 | 15 |
|----|----|----|----|------|----|----|----|

Low Back Guest 3 Seat Top No Center Arm

COM Yardage: 4.25
 Freight Class: 300
 Product Weight (lbs.): 82
 Cubic Feet Per Carton: 65.25

Triple frame guest top unit complete with 3 low back cushions and 3 seat cushions.

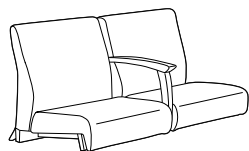

GC3623TOP

| COM | 2 | 3 | 4 | 5 | 6 | 7 | 8 | 9 | 10 | 11 | 12 |
|--------|--------|--------|--------|--------|--------|--------|--------|--------|--------|--------|--------|
| \$1689 | \$1765 | \$1826 | \$1918 | \$2047 | \$2096 | \$2209 | \$2422 | \$2528 | \$2726 | \$3001 | \$3001 |

OVERALL DIMENSIONS

W D H

SEAT DIMENSIONS

W D H

BACK DIMENSIONS

W H

| | | | | | | | |
|----|----|----|------|------|----|------|----|
| 42 | 25 | 19 | 20.5 | 17.5 | -- | 20.5 | 15 |
|----|----|----|------|------|----|------|----|

Low Back Guest 2 Seat Top Open Center Arm, Metal

COM Yardage: 3.25
 Freight Class: 300
 Product Weight (lbs.): 68
 Cubic Feet Per Carton: 45.75

Double frame guest top unit complete with 2 low back cushions, 2 seat cushions and metal half center, open arm, with wood armcap. SSU armcap option - Add \$33.50 list upcharge

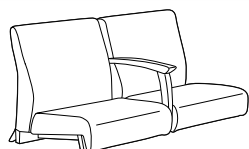

GC3623WTOP

| COM | 2 | 3 | 4 | 5 | 6 | 7 | 8 | 9 | 10 | 11 | 12 |
|--------|--------|--------|--------|--------|--------|--------|--------|--------|--------|--------|--------|
| \$1494 | \$1570 | \$1631 | \$1723 | \$1852 | \$1901 | \$2014 | \$2227 | \$2333 | \$2531 | \$2806 | \$2806 |

OVERALL DIMENSIONS

W D H

SEAT DIMENSIONS

W D H

BACK DIMENSIONS

W H

| | | | | | | | |
|----|----|----|------|------|----|------|----|
| 42 | 25 | 19 | 20.5 | 17.5 | -- | 20.5 | 15 |
|----|----|----|------|------|----|------|----|

Low Back Guest 2 Seat Top Open Center Arm, Wood

COM Yardage: 3.25
 Freight Class: 300
 Product Weight (lbs.): 68
 Cubic Feet Per Carton: 45.75

Double frame guest top unit complete with 2 low back cushions, 2 seat cushions and wood half center, open arm, with wood armcap. Specify finish. SSU armcap option - Add \$33.50 list upcharge

SEATING

PRIMACARE MODULAR P

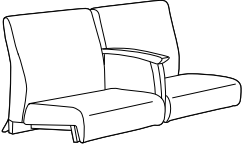
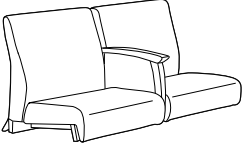
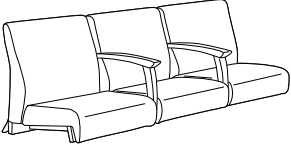
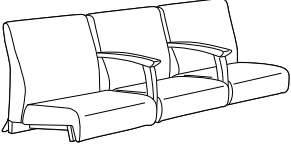
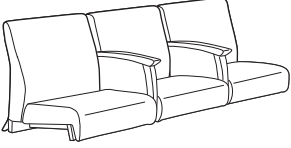
| DESCRIPTION | MODEL# | STANDARD FABRIC GRADES | | | | | | | | | | | |
|---|---------------------------|------------------------|--------|------------------------|--------|--------|------------------------|--------|--------|--------|--------|--------|--------|
| | | COM | 2 | 3 | 4 | 5 | 6 | 7 | 8 | 9 | 10 | 11 | 12 |
|  Low Back Guest 2 Seat Top Closed Center Arm, Metal COM Yardage: 3.50 Freight Class: 300 Product Weight (lbs.): 74 Cubic Feet Per Carton: 45.75 | GC3623CATOP | \$1782 | \$1863 | \$1929 | \$2027 | \$2166 | \$2219 | \$2341 | \$2570 | \$2685 | \$2898 | \$3194 | \$3194 |
| | OVERALL DIMENSIONS | | | SEAT DIMENSIONS | | | BACK DIMENSIONS | | | | | | |
| | W | D | H | W | D | H | W | H | | | | | |
| | 42 | 25 | 19 | 20.5 | 17.5 | -- | 20.5 | 15 | | | | | |
| Double frame guest top unit complete with 2 low back cushions, 2 seat cushions and metal half center, closed arm, with wood armcap. SSU armcap option - Add \$33.50 list upcharge | | | | | | | | | | | | | |
|  Low Back Guest 2 Seat Top Closed Center Arm, Wood COM Yardage: 3.5 Freight Class: 300 Product Weight (lbs.): 74 Cubic Feet Per Carton: 45.75 | GC3623WCATOP | \$1571 | \$1652 | \$1718 | \$1816 | \$1955 | \$2008 | \$2130 | \$2359 | \$2474 | \$2687 | \$2983 | \$2983 |
| | OVERALL DIMENSIONS | | | SEAT DIMENSIONS | | | BACK DIMENSIONS | | | | | | |
| | W | D | H | W | D | H | W | H | | | | | |
| | 42 | 25 | 19 | 20.5 | 17.5 | -- | 20.5 | 15 | | | | | |
| Double frame guest top unit complete with 2 low back cushions, 2 seat cushions and wood half center, closed arm, with wood armcap. Specify finish. SSU armcap option - Add \$33.50 list upcharge | | | | | | | | | | | | | |
|  Low Back Guest 3 Seat Top Open Center Arm, Metal COM Yardage: 4.75 Freight Class: 300 Product Weight (lbs.): 77 Cubic Feet Per Carton: 65.25 | GC3626TOP | \$2684 | \$2795 | \$2884 | \$3018 | \$3206 | \$3278 | \$3443 | \$3754 | \$3910 | \$4199 | \$4601 | \$4601 |
| | OVERALL DIMENSIONS | | | SEAT DIMENSIONS | | | BACK DIMENSIONS | | | | | | |
| | W | D | H | W | D | H | W | H | | | | | |
| | 64 | 25 | 19 | 20.5 | 17.5 | -- | 20.5 | 15 | | | | | |
| Triple frame guest top unit complete with 3 low back cushions, 3 seat cushions and metal half center, open arms, with wood armcaps. SSU armcap option - Add \$67 list upcharge | | | | | | | | | | | | | |
|  Low Back Guest 3 Seat Top Open Center Arm, Wood COM Yardage: 4.75 Freight Class: 300 Product Weight (lbs.): 77 Cubic Feet Per Carton: 65.25 | GC3626WTOP | \$2319 | \$2430 | \$2519 | \$2653 | \$2841 | \$2913 | \$3078 | \$3389 | \$3545 | \$3834 | \$4236 | \$4236 |
| | OVERALL DIMENSIONS | | | SEAT DIMENSIONS | | | BACK DIMENSIONS | | | | | | |
| | W | D | H | W | D | H | W | H | | | | | |
| | 64 | 25 | 19 | 20.5 | 17.5 | -- | 20.5 | 15 | | | | | |
| Triple frame guest top unit complete with 3 low back cushions, 3 seat cushions and wood half center, open arms, with wood armcaps. SSU armcap option - Add \$67 list upcharge | | | | | | | | | | | | | |
|  Low Back Guest 3 Seat Top Closed Center Arms, Metal COM Yardage: 5.50 Freight Class: 300 Product Weight (lbs.): 83 Cubic Feet Per Carton: 65.25 | GC3626CATOP | \$2865 | \$2993 | \$3097 | \$3251 | \$3469 | \$3552 | \$3744 | \$4104 | \$4284 | \$4619 | \$5084 | \$5084 |
| | OVERALL DIMENSIONS | | | SEAT DIMENSIONS | | | BACK DIMENSIONS | | | | | | |
| | W | D | H | W | D | H | W | H | | | | | |
| | 69 | 25 | 19 | 20.5 | 17.5 | -- | 20.5 | 15 | | | | | |
| Triple frame guest top unit complete with 3 low back cushions, 3 seat cushions and metal half center, closed arms, with wood armcaps. SSU armcap option - Add \$67 list upcharge | | | | | | | | | | | | | |

DESCRIPTION

MODEL#

STANDARD FABRIC GRADES

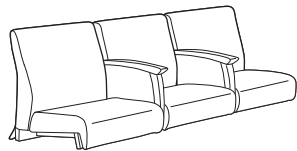

GC3626WCATOP

| COM | 2 | 3 | 4 | 5 | 6 | 7 | 8 | 9 | 10 | 11 | 12 |
|--------|--------|--------|--------|--------|--------|--------|--------|--------|--------|--------|--------|
| \$2466 | \$2594 | \$2698 | \$2852 | \$3071 | \$3153 | \$3345 | \$3705 | \$3885 | \$4220 | \$4685 | \$4685 |

| OVERALL DIMENSIONS | | | SEAT DIMENSIONS | | | BACK DIMENSIONS | |
|--------------------|---|---|-----------------|---|---|-----------------|---|
| W | D | H | W | D | H | W | H |

| | | | | | | | |
|----|----|----|------|------|----|------|----|
| 64 | 25 | 19 | 20.5 | 17.5 | -- | 20.5 | 15 |
|----|----|----|------|------|----|------|----|

Low Back Guest 3 Seat Top Closed Center Arms, Wood
COM Yardage: 5.50
Freight Class: 300
Product Weight (lbs.): 87
Cubic Feet Per Carton: 65.25

Triple frame guest top unit complete with 3 low back cushions, 3 seat cushions and **wood** half center, closed arms, with **wood armcaps**.
SSU armcap option - **Add \$67 list upcharge**



GC3637TOP

| COM | 2 | 3 | 4 | 5 | 6 | 7 | 8 | 9 | 10 | 11 | 12 |
|--------|--------|--------|--------|--------|--------|--------|--------|--------|--------|--------|--------|
| \$1054 | \$1112 | \$1159 | \$1230 | \$1329 | \$1367 | \$1454 | \$1617 | \$1699 | \$1851 | \$2063 | \$2063 |

| OVERALL DIMENSIONS | | | SEAT DIMENSIONS | | | BACK DIMENSIONS | |
|--------------------|---|---|-----------------|---|---|-----------------|---|
| W | D | H | W | D | H | W | H |

| | | | | | | | |
|----|----|----|----|------|----|----|----|
| 30 | 25 | 19 | 30 | 17.5 | -- | 30 | 15 |
|----|----|----|----|------|----|----|----|

Low Back Bariatric Guest Top
COM Yardage: 2.50
Freight Class: 250
Product Weight (lbs.): 53
Cubic Feet Per Carton: 26.50

Single frame bariatric guest top unit complete with 1 low back cushion and 1 seat cushion.
• **Must be connected to a full arm/leg frame**

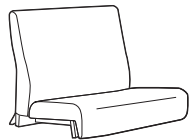

GC3638TOP

| COM | 2 | 3 | 4 | 5 | 6 | 7 | 8 | 9 | 10 | 11 | 12 |
|--------|--------|--------|--------|--------|--------|--------|--------|--------|--------|--------|--------|
| \$1123 | \$1187 | \$1239 | \$1316 | \$1425 | \$1467 | \$1563 | \$1743 | \$1833 | \$2000 | \$2233 | \$2233 |

| OVERALL DIMENSIONS | | | SEAT DIMENSIONS | | | BACK DIMENSIONS | |
|--------------------|---|---|-----------------|---|---|-----------------|---|
| W | D | H | W | D | H | W | H |

| | | | | | | | |
|----|----|----|----|------|----|----|----|
| 30 | 25 | 22 | 30 | 17.5 | -- | 30 | 18 |
|----|----|----|----|------|----|----|----|

Mid Back Bariatric Patient Top
COM Yardage: 2.75
Freight Class: 250
Product Weight (lbs.): 62
Cubic Feet Per Carton: 30.50

Single frame bariatric patient top unit complete with 1 medium back cushion and 1 seat cushion.
• **Must be connected to a full arm/leg frame**

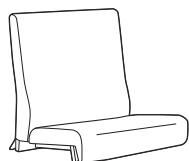

GC3656TOP

| COM | 2 | 3 | 4 | 5 | 6 | 7 | 8 | 9 | 10 | 11 | 12 |
|--------|--------|--------|--------|--------|--------|--------|--------|--------|--------|--------|--------|
| \$1179 | \$1260 | \$1326 | \$1424 | \$1563 | \$1616 | \$1738 | \$1967 | \$2082 | \$2295 | \$2591 | \$2591 |

| OVERALL DIMENSIONS | | | SEAT DIMENSIONS | | | BACK DIMENSIONS | |
|--------------------|---|---|-----------------|---|---|-----------------|---|
| W | D | H | W | D | H | W | H |

| | | | | | | | |
|----|----|----|----|------|----|----|----|
| 30 | 25 | 34 | 30 | 17.5 | -- | 30 | 30 |
|----|----|----|----|------|----|----|----|

High Back Bariatric Patient Top
COM Yardage: 3.50
Freight Class: 250
Product Weight (lbs.): 62
Cubic Feet Per Carton: 30.75

Single frame bariatric patient top unit complete with 1 high back cushion and 1 seat cushion.
• **Must be connected to a full arm/leg frame**

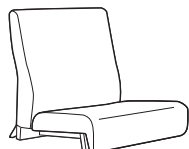

GC3631TOP

| COM | 2 | 3 | 4 | 5 | 6 | 7 | 8 | 9 | 10 | 11 | 12 |
|-------|-------|-------|-------|-------|-------|-------|--------|--------|--------|--------|--------|
| \$694 | \$734 | \$767 | \$816 | \$886 | \$912 | \$973 | \$1088 | \$1145 | \$1252 | \$1400 | \$1400 |

| OVERALL DIMENSIONS | | | SEAT DIMENSIONS | | | BACK DIMENSIONS | |
|--------------------|---|---|-----------------|---|---|-----------------|---|
| W | D | H | W | D | H | W | H |

| | | | | | | | |
|------|----|----|------|------|----|------|----|
| 20.5 | 25 | 22 | 20.5 | 17.5 | -- | 20.5 | 18 |
|------|----|----|------|------|----|------|----|

Mid Back Patient Top
COM Yardage: 1.75
Freight Class: 150
Product Weight (lbs.): 42
Cubic Feet Per Carton: 10

Single frame patient top unit complete with 1 medium back cushion and 1 seat cushion.

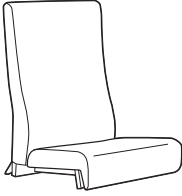
| DESCRIPTION | MODEL# | STANDARD FABRIC GRADES | | | | | | | | | | | |
|---|---------------------------|------------------------|-------|------------------------|-------|--------|------------------------|--------|--------|--------|--------|--------|--------|
| | | COM | 2 | 3 | 4 | 5 | 6 | 7 | 8 | 9 | 10 | 11 | 12 |
|  <p>High Back Patient Top COM Yardage: 2.50 Freight Class: 250 Product Weight (lbs.): 52 Cubic Feet Per Carton: 13.25</p> | GC3655TOP | \$750 | \$808 | \$855 | \$925 | \$1025 | \$1063 | \$1150 | \$1313 | \$1395 | \$1547 | \$1759 | \$1759 |
| | OVERALL DIMENSIONS | | | SEAT DIMENSIONS | | | BACK DIMENSIONS | | | | | | |
| | W | D | H | W | D | H | W | H | | | | | |
| | | | 20.5 | 25 | 34 | 20.5 | 17.5 | -- | 20.5 | 30 | | | |

Single frame patient top unit complete with 1 high back cushion and 1 seat cushion.

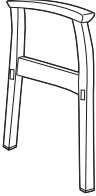
| | | | | | | | | | | | | | |
|---|---------------------------|-------------------|---|------------------------|----|------|------------------------|---|--|--|--|--|--|
|  <p>Left End Frame, Open Arm COM Yardage: -- Freight Class: 125 Product Weight (lbs.): 10 Cubic Feet Per Carton: 1.40</p> | | List Price | | | | | | | | | | | |
| | GC3620LA (metal) | \$377 | | | | | | | | | | | |
| | GC3620WLA (wood) | \$268 | | | | | | | | | | | |
| | OVERALL DIMENSIONS | | | SEAT DIMENSIONS | | | BACK DIMENSIONS | | | | | | |
| | W | D | H | W | D | H | W | H | | | | | |
| | | | | 2.5 | 27 | 26.5 | | | | | | | |

Metal left end full leg open arm frame with **left wood armcap**.
Wood left end full leg open arm frame with **left wood armcap**.
• For use in left side finished position of guest and/or patient seating units. **Note: Does not allow linking to other units or tables.**
SSU armcap option - **Add \$33.50 list upcharge**

| | | | | | | | | | | | | | |
|---|---------------------------|-------------------|---|------------------------|----|------|------------------------|---|--|--|--|--|--|
|  <p>Right End Frame, Open Arm COM Yardage: -- Freight Class: 125 Product Weight (lbs.): 10 Cubic Feet Per Carton: 1.40</p> | | List Price | | | | | | | | | | | |
| | GC3620RA (metal) | \$377 | | | | | | | | | | | |
| | GC3620WRA (wood) | \$268 | | | | | | | | | | | |
| | OVERALL DIMENSIONS | | | SEAT DIMENSIONS | | | BACK DIMENSIONS | | | | | | |
| | W | D | H | W | D | H | W | H | | | | | |
| | | | | 2.5 | 27 | 26.5 | | | | | | | |

Metal right end full leg open arm frame with **right wood armcap**.
Wood right end full leg open arm frame with **right wood armcap**.
• For use in right side finished position of guest and/or patient seating units. **Note: Does not allow linking to other units or tables.**
SSU armcap option - **Add \$33.50 list upcharge**

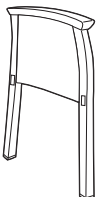
| DESCRIPTION | MODEL# | STANDARD FABRIC GRADES | | | | | | | | | | | |
|---|---------------------------|------------------------|-------|------------------------|-------|-------|------------------------|-------|-------|-------|-------|-------|-------|
| | | COM | 2 | 3 | 4 | 5 | 6 | 7 | 8 | 9 | 10 | 11 | 12 |
|  <p>Left End Frame, Closed Arm COM Yardage: .65 Freight Class: 92.5 Product Weight (lbs.): 15 Cubic Feet Per Carton: 1.40</p> | GC3620LCA (metal) | \$461 | \$476 | \$489 | \$507 | \$533 | \$543 | \$565 | \$608 | \$629 | \$669 | \$724 | \$724 |
| | GC3620WLCA (wood) | \$335 | \$350 | \$363 | \$381 | \$407 | \$417 | \$439 | \$482 | \$503 | \$543 | \$598 | \$598 |
| | OVERALL DIMENSIONS | | | SEAT DIMENSIONS | | | BACK DIMENSIONS | | | | | | |
| | W | D | H | W | D | H | W | H | | | | | |
| | | | | 2.5 | 27 | 26.5 | | | | | | | |

Metal left end full leg closed arm frame with **left wood armcap**.
Wood left end full leg closed arm frame with **left wood armcap**.
• For use in left side finished position of guest and/or patient units. **Note: Does not allow linking to other units or tables.**
SSU armcap option - **Add \$33.50 list upcharge**

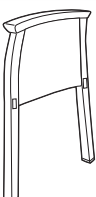
| | | | | | | | | | | | | | |
|--|---------------------------|-------------------|-------|------------------------|-------|-------|------------------------|-------|-------|-------|-------|-------|-------|
|  <p>Right End Frame, Closed Arm COM Yardage: .65 Freight Class: 92.5 Product Weight (lbs.): 15 Cubic Feet Per Carton: 1.40</p> | | List Price | | | | | | | | | | | |
| | GC3620RCA (metal) | \$461 | \$476 | \$489 | \$507 | \$533 | \$543 | \$565 | \$608 | \$629 | \$669 | \$724 | \$724 |
| | GC3620WRCA (wood) | \$335 | \$350 | \$363 | \$381 | \$407 | \$417 | \$439 | \$482 | \$503 | \$543 | \$598 | \$598 |
| | OVERALL DIMENSIONS | | | SEAT DIMENSIONS | | | BACK DIMENSIONS | | | | | | |
| | W | D | H | W | D | H | W | H | | | | | |
| | | | | 2.5 | 27 | 26.5 | | | | | | | |

Metal right end full leg closed arm frame with **right wood armcap**.
Wood right end full leg closed arm frame with **right wood armcap**.
• For use in right side finished position of guest and/or patient units. **Note: Does not allow linking to other units or tables.**
SSU armcap option - **Add \$33.50 list upcharge**

DESCRIPTION

MODEL#

STANDARD FABRIC GRADES

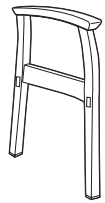

Center Frame, Open Arm

COM Yardage: --
 Freight Class: 125
 Product Weight (lbs.) Metal: 10 / Wood: 8
 Cubic Feet Per Carton: 1.40

GC3622LA
 (metal)

GC3622WLA
 (wood)

List Price

\$420

\$279

OVERALL DIMENSIONS

W D H

1.5 27 26.5

SEAT DIMENSIONS

W D H

BACK DIMENSIONS

W H

Metal center linking full leg open arm frame with **center wood armcap.**
Wood center linking full leg open arm frame with **center wood armcap.**
 • For **linking** guest and/or patient top seating units.
 SSU armcap option - **Add \$33.50 list upcharge**

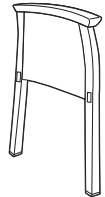

Center Frame, Closed Arm

COM Yardage: .65
 Freight Class: 92.5
 Product Weight (lbs.) Metal: 15 / Wood: 10
 Cubic Feet Per Carton: 1.40

GC3622LCA
 (metal)

GC3622WLCA
 (wood)

| COM | 2 | 3 | 4 | 5 | 6 | 7 | 8 | 9 | 10 | 11 | 12 |
|-----|---|---|---|---|---|---|---|---|----|----|----|
|-----|---|---|---|---|---|---|---|---|----|----|----|

\$472 \$487 \$500 \$518 \$544 \$554 \$576 \$619 \$640 \$680 \$734 \$734

\$346 \$361 \$374 \$392 \$418 \$428 \$450 \$493 \$514 \$554 \$608 \$608

OVERALL DIMENSIONS

W D H

1.5 27 26.5

SEAT DIMENSIONS

W D H

BACK DIMENSIONS

W H

Metal center linking full leg closed arm frame with **center wood armcap.**
Wood center linking full leg closed arm frame with **center wood armcap.**
 • For **linking** guest and/or patient top seating units.
 SSU armcap option - **Add \$33.50 list upcharge**

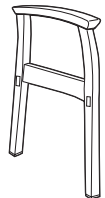

Center Frame, Open Arm

COM Yardage: --
 Freight Class: 125
 Product Weight (lbs.) Metal: 10 / Wood: 8
 Cubic Feet Per Carton: 1.40

GC3622TLA
 (metal)

GC3622WTLA
 (wood)

List Price

\$410

\$301

OVERALL DIMENSIONS

W D H

1.5 27 26.5

SEAT DIMENSIONS

W D H

BACK DIMENSIONS

W H

Metal center linking full leg open arm frame with **left wood armcap.**
Wood center linking full leg open arm frame with **left wood armcap.**
 • For **linking** guest or patient top to modular table on the **left** side of the frame.
 SSU armcap option - **Add \$33.50 list upcharge**

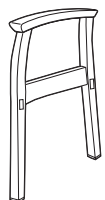

Center Frame, Open Arm

COM Yardage: --
 Freight Class: 125
 Product Weight (lbs.) Metal: 10 / Wood: 8
 Cubic Feet Per Carton: 1.40

GC3622TRA
 (metal)

GC3622WTRA
 (wood)

List Price

\$410

\$301

OVERALL DIMENSIONS

W D H

1.5 27 26.5

SEAT DIMENSIONS

W D H

BACK DIMENSIONS

W H

Metal center linking full leg open arm frame with **right wood armcap.**
Wood center linking full leg open arm frame with **right wood armcap.**
 • For **linking** guest or patient top to modular table on the **right** side of the frame.
 SSU armcap option - **Add \$33.50 list upcharge**

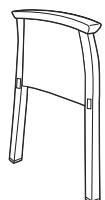

Center Frame, Closed Arm

COM Yardage: .65
 Freight Class: 92.5
 Product Weight (lbs.) Metal: 15 / Wood: 10
 Cubic Feet Per Carton: 1.40

GC3622TLCA
 (metal)

GC3622WTLCA
 (wood)

| COM | 2 | 3 | 4 | 5 | 6 | 7 | 8 | 9 | 10 | 11 | 12 |
|-----|---|---|---|---|---|---|---|---|----|----|----|
|-----|---|---|---|---|---|---|---|---|----|----|----|

\$494 \$509 \$522 \$540 \$566 \$576 \$598 \$641 \$662 \$702 \$757 \$757

\$368 \$383 \$396 \$414 \$440 \$450 \$472 \$515 \$536 \$576 \$631 \$631

OVERALL DIMENSIONS

W D H

1.5 27 26.5

SEAT DIMENSIONS

W D H

BACK DIMENSIONS

W H

Metal center linking full leg closed arm frame with **left wood armcap.**
Wood center linking full leg closed arm frame with **left wood armcap.**
 • For **linking** guest or patient top to modular table on the **left** side of the frame.
 SSU armcap option - **Add \$33.50 list upcharge**

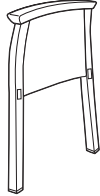

| DESCRIPTION | MODEL# | STANDARD FABRIC GRADES | | | | | | | | | | | |
|--|-----------------------|---|-------|-------|-----------------|-------|-------|-----------------|-------|-------|-------|-------|-------|
| | | COM | 2 | 3 | 4 | 5 | 6 | 7 | 8 | 9 | 10 | 11 | 12 |
|  <p>Center Frame, Closed Arm COM Yardage: .65 Freight Class: 92.5 Product Weight (lbs.) Metal: 15 / Wood: 10 Cubic Feet Per Carton: 1.40</p> | GC3622TRCA (metal) | \$494 | \$509 | \$522 | \$540 | \$566 | \$576 | \$598 | \$641 | \$662 | \$702 | \$757 | \$757 |
| | GC3622WTRCA (wood) | \$368 | \$383 | \$396 | \$414 | \$440 | \$450 | \$472 | \$515 | \$536 | \$576 | \$631 | \$631 |
| | | OVERALL DIMENSIONS | | | SEAT DIMENSIONS | | | BACK DIMENSIONS | | | | | |
| | | W | D | H | W | D | H | W | H | | | | |
| | | 1.5 | 27 | 26.5 | | | | | | | | | |
| | | <p>Metal center linking full leg closed arm frame with right wood armcap. Wood center linking full leg closed arm frame with right wood armcap. • For linking guest or patient top to modular table on the right side of the frame. SSU armcap option - Add \$33.50 list upcharge</p> | | | | | | | | | | | |

| DESCRIPTION | MODEL# | List Price | | | | | | | | | | | |
|-------------|------------------------|--|-------------------------|-------|-----------------|---|---|-----------------|---|--|--|--|--|
| | |  <p>Armcap, Left COM Yardage: -- Freight Class: 250 Product Weight (lbs.) SSU: 2 / Wood: 1.50 Cubic Feet Per Carton: .60</p> | GC3616SSULACAP (SSU) | \$111 | | | | | | | | | |
| | GC3616WLACAP (wood) | \$133 | | | | | | | | | | | |
| | | OVERALL DIMENSIONS | | | SEAT DIMENSIONS | | | BACK DIMENSIONS | | | | | |
| | | W | D | H | W | D | H | W | H | | | | |
| | | 2.5 | 20.5 | 1.5 | | | | | | | | | |
| | | <p>Armcap with hardware for Dining chair • For field replacement only</p> | | | | | | | | | | | |

| DESCRIPTION | MODEL# | List Price | | | | | | | | | | | |
|-------------|------------------------|---|-------------------------|-------|-----------------|---|---|-----------------|---|--|--|--|--|
| | |  <p>Armcap, Right COM Yardage: -- Freight Class: 250 Product Weight (lbs.) SSU: 2 / Wood: 1.50 Cubic Feet Per Carton: .60</p> | GC3616SSURACAP (SSU) | \$111 | | | | | | | | | |
| | GC3616WRACAP (wood) | \$133 | | | | | | | | | | | |
| | | OVERALL DIMENSIONS | | | SEAT DIMENSIONS | | | BACK DIMENSIONS | | | | | |
| | | W | D | H | W | D | H | W | H | | | | |
| | | 2.5 | 20.5 | 1.5 | | | | | | | | | |
| | | <p>Armcap with hardware for Dining chair • For field replacement only</p> | | | | | | | | | | | |

| DESCRIPTION | MODEL# | List Price | | | | | | | | | | | |
|-------------|------------------------|--|-------------------------|-------|-----------------|---|---|-----------------|---|--|--|--|--|
| | |  <p>Armcap, Left COM Yardage: -- Freight Class: 150 Product Weight (lbs.) SSU: 2.50 / Wood: 2 Cubic Feet Per Carton: .60</p> | GC3620SSULACAP (SSU) | \$111 | | | | | | | | | |
| | GC3620WLACAP (wood) | \$133 | | | | | | | | | | | |
| | | OVERALL DIMENSIONS | | | SEAT DIMENSIONS | | | BACK DIMENSIONS | | | | | |
| | | W | D | H | W | D | H | W | H | | | | |
| | | 2 | 20.5 | 1.5 | | | | | | | | | |
| | | <p>Armcap with hardware for Guest and Patient chair • For field replacement only</p> | | | | | | | | | | | |

| DESCRIPTION | MODEL# | List Price | | | | | | | | | | | |
|-------------|------------------------|---|-------------------------|-------|-----------------|---|---|-----------------|---|--|--|--|--|
| | |  <p>Armcap, Right COM Yardage: -- Freight Class: 150 Product Weight (lbs.) SSU: 2.50 / Wood: 2 Cubic Feet Per Carton: .60</p> | GC3620SSURACAP (SSU) | \$111 | | | | | | | | | |
| | GC3620WRACAP (wood) | \$133 | | | | | | | | | | | |
| | | OVERALL DIMENSIONS | | | SEAT DIMENSIONS | | | BACK DIMENSIONS | | | | | |
| | | W | D | H | W | D | H | W | H | | | | |
| | | 2 | 20.5 | 1.5 | | | | | | | | | |
| | | <p>Armcap with hardware for Guest and Patient chair • For field replacement only</p> | | | | | | | | | | | |

| DESCRIPTION | MODEL# | STANDARD FABRIC GRADES | | | | | | | | |
|--|--------------------------------|---|---|---|-----------------|---|---|-----------------|---|--|
| | | OVERALL DIMENSIONS | | | SEAT DIMENSIONS | | | BACK DIMENSIONS | | |
| | | W | D | H | W | D | H | W | H | |
|  <p>Narrow Center Armcap COM Yardage: -- Freight Class: 70 Product Weight (lbs.) SSU: 1.50 / Wood: 1.50 Cubic Feet Per Carton: .60</p> | | List Price | | | | | | | | |
| | GC3622SSULACAP (SSU) | \$111 | | | | | | | | |
| | GC3622WLACAP (wood) | \$133 | | | | | | | | |
| | | 1.5 | | | 23 | | | 1.5 | | |
| | | Armcap with hardware for Guest and Patient chair . | | | | | | | | |
| | | • For field replacement only | | | | | | | | |
|  <p>Armcap, Left COM Yardage: -- Freight Class: 150 Product Weight (lbs.) SSU: 2.50 / Wood: 2 Cubic Feet Per Carton: .60</p> | | List Price | | | | | | | | |
| | GC3641SSULACAP (SSU) | \$126 | | | | | | | | |
| | GC3641WLACAP (wood) | \$159 | | | | | | | | |
| | | 3 | | | 26.75 | | | 1.5 | | |
| | | Armcap with hardware for Lounge chair | | | | | | | | |
| | | • For field replacement only | | | | | | | | |
|  <p>Armcap, Right COM Yardage: -- Freight Class: 150 Product Weight (lbs.) SSU: 2.50 / Wood: 2 Cubic Feet Per Carton: .60</p> | | List Price | | | | | | | | |
| | GC3641SSURACAP (SSU) | \$126 | | | | | | | | |
| | GC3641WRACAP (wood) | \$159 | | | | | | | | |
| | | 3 | | | 26.75 | | | 1.5 | | |
| | | Armcap with hardware for Lounge chair | | | | | | | | |
| | | • For field replacement only | | | | | | | | |

DESCRIPTION

MODEL#

STANDARD FABRIC GRADES

Modular Table Notes

Tops are 1" thick.

Wooden Leg Tables:

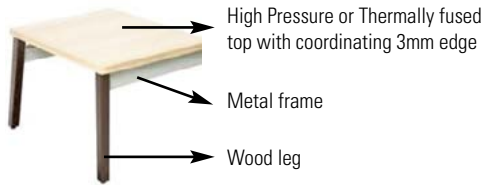

Metal Leg Tables:

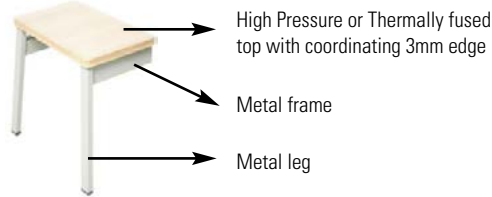

Table Top Finishes

Thermally Fused Laminate (L)

- (ACJ) Absolute Acajou
- (ASN) Asian Night
- (AWC) Avant Cherry
- (AWH) Avant Honey
- (BRC) Brushed Cobalt
- (CSJ) Constellation Java
- (DES) Dark Espresso
- (HGT) Hayden Grey
- (QTM) Quartered Mahogany
- (SKC) Shaker Cherry
- (TFW) Tiger Fruitwood
- (TMA) Tiger Mahogany
- (TMP) Tiger Maple
- (TWL) Tiger Walnut
- (WHT) White
- (WHC) White Chocolate
- (WCR) Winter Cherry

High Pressure Laminate (H)

- (W357) Avant Cherry
- (W356) Avant Honey
- (BCH) Brushed Cobalt
- (CJH) Constellation Java
- (W142) Dark Espresso
- (W313) Quartered Mahogany
- (SKB) Shaker Cherry
- (W821) Tiger Fruitwood
- (W822) Tiger Mahogany
- (W820) Tiger Maple
- (W819) Tiger Walnut
- (S645) White
- (W149) Winter Cherry
- (CMB) Clear Maple
- (EMB) Empire Mahogany

Wooden Leg Finishes:

- (Top, Base, Legs & Apron Finish)
- (AAM) Absolute
- (BPM) Brandy Peppercorn on Maple
- (ACM) Cherry on Maple
- (CVM) Cocoa Vanilla on Maple
- (EOM) English Oak on Maple
- (TFM) Fruitwood on Maple
- (HOM) Harvest Oak on Maple
- (JOM) Jet Onyx on Maple
- (MWM) Medium Walnut on Maple
- (AVM) Maple on Maple
- (SKM) Shaker Cherry on Maple
- (TWM) Tiger Walnut on Maple
- (WCM) Winter Cherry on Maple
- (ASM) Night
- (CJM) Charcoal Java on Maple
- (CLM) Cherry Latte on Maple
- (EMM) Empire Mahogany on Maple
- (ECM) Espresso Cafe on Maple
- (HGM) Gray
- (AHM) Honey on Maple
- (LHM) Light Honey on Maple
- (TMM) Tiger Mahogany on Maple
- (SBM) Sandy Beach on Maple
- (SOM) Silver Oak on Maple
- (WHM) White on Maple
- (WTM) WC Cream

Metal Leg Finishes:

Available in **Black (BLK), Tungsten (TUN), Toast (TOA), Platinum (PLT), Kalua (KAL), Mocha (J52)** and **Cappuccino (T20)**.

Metal Frame Finishes

Available in **Black (BLK), Tungsten (TUN), Toast (TOA), Platinum (PLT), Kalua (KAL), Mocha (J52)** and **Cappuccino (T20)**.

| MODULAR TABLES | MODEL# | DIMENSIONS D x W x H | FREIGHT CLASS | WT/LBS. | CUBIC FT. | LIST PRICE |
|---|-------------|-------------------------|---------------|---------|-----------|--------------|
|  | GC3671WL-LP | 33 x 33 x 17 | 100 | 54 | 6 | \$855 |
| | GC3671WL-HP | 33 x 33 x 17 | 100 | 54 | 6 | \$914 |

- For a thermally fused laminate top (LP), specify model GC3671WL-LP.
- For a high pressure laminate top (HP), specify model GC3671WL-HP.

Left Corner Table, for Wood Frame

Coordinating 3mm edge. Must be connected to full arm and leg with **wood** frames. (GC3622WTLA/WTRA, GC3622WTLCA/WTRCA). This table allows for kneespace when specifying chairs in a corner position.

- Includes 2 rear legs (not shown)

| | | | | | | |
|---|------------|--------------|-----|----|---|--------------|
|  | GC3671L-LP | 33 x 33 x 17 | 100 | 54 | 6 | \$889 |
| | GC3671L-HP | 33 x 33 x 17 | 125 | 45 | 6 | \$966 |

- For a thermally fused laminate top (LP), specify model GC3671L-LP.
- For a high pressure laminate top (HP), specify model GC3671L-HP.

Left Corner Table, for Metal Frame

Coordinating 3mm edge. Must be connected to full arm and leg with **metal** frames. (GC3622TLA/TRA, GC3622TLCA/TRCA). This table allows for kneespace when specifying chairs in a corner position.

- Includes 2 rear legs (not shown)

| | | | | | | |
|---|-------------|--------------|-----|----|---|--------------|
|  | GC3671WR-LP | 33 x 33 x 17 | 100 | 54 | 6 | \$855 |
| | GC3671WR-HP | 33 x 33 x 17 | 100 | 54 | 6 | \$914 |

- For a thermally fused laminate top (LP), specify model GC3671WR-LP.
- For a high pressure laminate top (HP), specify model GC3671WR-HP.

Right Corner Table, for Wood Frame

Coordinating 3mm edge. Must be connected to full arm and leg with **wood** frames. (GC3622WTLA/WTRA, GC3622WTLCA/WTRCA). This table allows for kneespace when specifying chairs in a corner position.

- Includes 2 rear legs (not shown)

| | | | | | | |
|---|------------|--------------|-----|----|---|--------------|
|  | GC3671R-LP | 33 x 33 x 17 | 100 | 54 | 6 | \$889 |
| | GC3671R-HP | 33 x 33 x 17 | 125 | 45 | 6 | \$966 |

- For a thermally fused laminate top (LP), specify model GC3671R-LP.
- For a high pressure laminate top (HP), specify model GC3671R-HP.

Right Corner Table, for Metal Frame

Coordinating 3mm edge. Must be connected to full arm and leg with **metal** frames. (GC3622TLA/TRA, GC3622TLCA/TRCA). This table allows for kneespace when specifying chairs in a corner position.

- Includes 2 rear legs (not shown)

| | | | | | | |
|---|-----------|--------------------|-----|----|------|--------------|
|  | GC3672-LP | 23.87 x 20.25 x 17 | 150 | 20 | 3.40 | \$516 |
| | GC3672-HP | 23.87 x 20.25 x 17 | 150 | 20 | 3.40 | \$542 |

- For a thermally fused laminate top (LP), specify model GC3672-LP.
- For a high pressure laminate top (HP), specify model GC3672-HP.

Center Table

Coordinating 3mm edge. Regular center table for **wood or metal** (HT) frame. Must be connected to full arm and leg with **metal** or **wood** frames. (GC3622TLA/TRA, GC3622TLCA/TRCA, GC3622WTLA/WTRA, GC3622WTLCA/WTRCA).

| | | | | | | |
|---|-----------|------------------|-----|----|------|--------------|
|  | GC3673-LP | 23.87 x 12 x 5.5 | 100 | 18 | 2.10 | \$502 |
| | GC3673-HP | 23.87 x 12 x 5.5 | 100 | 18 | 2.10 | \$527 |

- For a thermally fused laminate top (LP), specify model GC3673-LP.
- For a high pressure laminate top (HP), specify model GC3673-HP.

Narrow Center Table

Coordinating 3mm edge. Narrow center table for **wood or metal** (HT) frame. Must be connected to full arm and leg with **metal** or **wood** frames. (GC3622TLA/TRA, GC3622TLCA/TRCA, GC3622WTLA/WTRA, GC3622WTLCA/WTRCA).

MODULAR TABLES

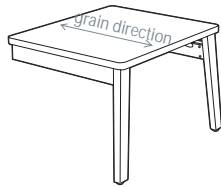

Left End Table, for Wood Frame

| MODEL# | DIMENSIONS D x W x H | FREIGHT CLASS | WT/LBS. | CUBIC FT. | LIST PRICE |
|-------------|-------------------------|---------------|---------|-----------|--------------|
| GC3674WL-LP | 23.87 x 20.25 x 17 | 100 | 32 | 3.40 | \$712 |
| GC3674WL-HP | 23.87 x 20.25 x 17 | 150 | 20 | 3.40 | \$738 |

- For a thermally fused laminate top (LP), specify model GC3674WL-LP.
- For a high pressure laminate top (HP), specify model GC3674WL-HP.

Coordinating 3mm edge. Must be connected to full arm and leg with **wood** frames. (GC3622WTLA or GC3622WTLCA).

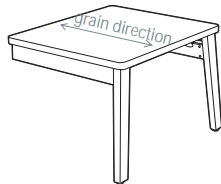

Left End Table, for Metal Frame

| | | | | | |
|------------|--------------------|-----|----|------|--------------|
| GC3674L-LP | 23.87 x 20.25 x 17 | 100 | 32 | 3.40 | \$763 |
| GC3674L-HP | 23.87 x 20.25 x 17 | 150 | 32 | 3.4 | \$789 |

- For a thermally fused laminate top (LP), specify model GC3674L-LP.
- For a high pressure laminate top (HP), specify model GC3674L-HP.

Coordinating 3mm edge. Must be connected to full arm and leg with **metal** frames. (GC3622TLA or GC3622TLCA).

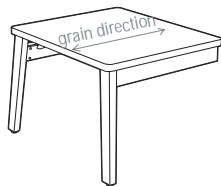

Right End Table, for Wood Frame

| | | | | | |
|-------------|--------------------|-----|----|------|--------------|
| GC3674WR-LP | 23.87 x 20.25 x 17 | 100 | 32 | 3.40 | \$712 |
| GC3674WR-HP | 23.87 x 20.25 x 17 | 150 | 20 | 3.40 | \$738 |

- For a thermally fused laminate top (LP), specify model GC3674WR-LP.
- For a high pressure laminate top (HP), specify model GC3674WR-HP.

Coordinating 3mm edge. Must be connected to full arm and leg with **wood** frames. (GC3622WTRA or GC3622WTRCA).

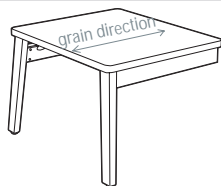

Right End Table, for Metal Frame

| | | | | | |
|------------|--------------------|-----|----|------|--------------|
| GC3674R-LP | 23.87 x 20.25 x 17 | 100 | 32 | 3.40 | \$763 |
| GC3674R-HP | 23.87 x 20.25 x 17 | 150 | 20 | 3.40 | \$789 |

- For a thermally fused laminate top (LP), specify model GC3674R-LP.
- For a high pressure laminate top (HP), specify model GC3674R-HP.

Coordinating 3mm edge. Must be connected to full arm and leg with **metal** frames. (GC3622TRA or GC3622TRCA).

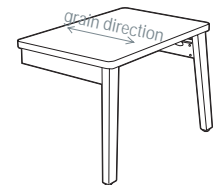

Narrow Left End Table, for Wood Frame

| | | | | | |
|-------------|--------------------|-----|----|------|--------------|
| GC3675WL-LP | 23.87 x 20.25 x 17 | 100 | 18 | 2.10 | \$697 |
| GC3675WL-HP | 23.87 x 20.25 x 17 | 100 | 18 | 2.10 | \$723 |

- For a thermally fused laminate top (LP), specify model GC3675WL-LP.
- For a high pressure laminate top (HP), specify model GC3675WL-HP.

Coordinating 3mm edge. Must be connected to full arm and leg with **wood** frames. (GC3622WTLA or GC3622WTLCA).

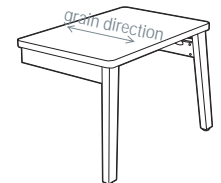

Narrow Left End Table, for Metal Frame

| | | | | | |
|------------|--------------------|-----|----|------|--------------|
| GC3675L-LP | 23.87 x 20.25 x 17 | 100 | 18 | 2.10 | \$749 |
| GC3675L-HP | 23.87 x 20.25 x 17 | 100 | 18 | 2.10 | \$774 |

- For a thermally fused laminate top (LP), specify model GC3675L-LP.
- For a high pressure laminate top (HP), specify model GC3675L-HP.

Coordinating 3mm edge. Must be connected to full arm and leg with **metal** frames. (GC3622TLA or GC3622TLCA).

MODULAR TABLES MODEL# DIMENSIONS FREIGHT CLASS WT/LBS. CUBIC FT. LIST PRICE

D x W x H

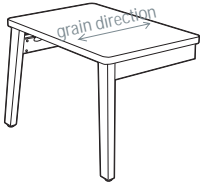

| | | | | | |
|-------------|--------------------|-----|----|------|--------------|
| GC3675WR-LP | 23.87 x 20.25 x 17 | 100 | 18 | 2.10 | \$697 |
| GC3675WR-HP | 23.87 x 20.25 x 17 | 100 | 18 | 2.10 | \$723 |

- For a thermally fused laminate top (LP), specify model GC3675WR-LP.
- For a high pressure laminate top (HP), specify model GC3675WR-HP.

Narrow Right End Table, for Wood Frame

Coordinating 3mm edge. Must be connected to full arm and leg with **wood** frames. (GC3622WTLA or GC3622WTLCA).

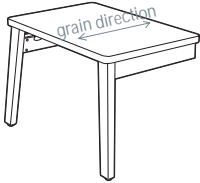

| | | | | | |
|------------|--------------------|-----|----|------|--------------|
| GC3675R-LP | 23.87 x 20.25 x 17 | 100 | 18 | 2.10 | \$749 |
| GC3675R-HP | 23.87 x 20.25 x 17 | 100 | 18 | 2.10 | \$774 |

- For a thermally fused laminate top (LP), specify model GC3675R-LP.
- For a high pressure laminate top (HP), specify model GC3675R-HP.

Narrow Right End Table, for Metal Frame

Coordinating 3mm edge. Must be connected to full arm and leg with **metal** frames. (GC3622TLA or GC3622TLCA).

ROOSEVELT



model GC3800

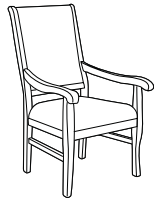

Armchair
COM Yardage: 1.75
Freight Class: 300
Product Weight (lbs.): 36
Cubic Feet Per Carton: 20

STANDARD FEATURES

- High back offering and unique curl detail at the top of the back and on the armrests.
- Seat and back provide exceptional comfort while the support rails in the lower frame offer strength and stability.
- For Globalcare textiles and wood finish options, visit the web site at www.thinkglobalcare.com. **Available in Maple wood Only.**
- This product is shipped fully assembled.
- Front Casters available on model ending with **FC**.
- Standard glide is plastic. For Non-slip glides specify (NS) - **Add \$21.00** list upcharge.

- High density Ultracell foam. Moisture Barrier (Seat Only) - **Add \$85.00** list upcharge.
- For addition of a Fire Barrier Lining - **Add \$65.00** list upcharge per yard.
- Call Customer Service for **CAL133** approved textiles.

SUGGESTED APPLICATIONS

- Dining Rooms
- Resident Rooms
- Waiting Areas

GC3800

| COM | 2 | 3 | 4 | 5 | 6 | 7 | 8 | 9 | 10 | 11 | 12 |
|--------|--------|--------|--------|--------|--------|--------|--------|--------|--------|--------|--------|
| \$1386 | \$1421 | \$1525 | \$1574 | \$1642 | \$1667 | \$1727 | \$1840 | \$1895 | \$2000 | \$2144 | \$2144 |

| OVERALL DIMENSIONS | | | SEAT DIMENSIONS | | | BACK DIMENSIONS | |
|--------------------|----|----|-----------------|------|----|-----------------|----|
| W | D | H | W | D | H | W | H |
| 24.5 | 28 | 42 | 20.5 | 18.5 | 18 | 19 | 24 |

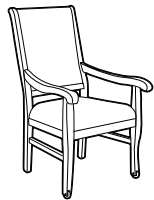

Armchair Front Casters
COM Yardage: 1.75
Freight Class: 300
Product Weight (lbs.): 36
Cubic Feet Per Carton: 20

GC3800FC

| COM | 2 | 3 | 4 | 5 | 6 | 7 | 8 | 9 | 10 | 11 | 12 |
|--------|--------|--------|--------|--------|--------|--------|--------|--------|--------|--------|--------|
| \$1493 | \$1534 | \$1645 | \$1698 | \$1770 | \$1798 | \$1862 | \$1982 | \$2043 | \$2155 | \$2311 | \$2311 |

| OVERALL DIMENSIONS | | | SEAT DIMENSIONS | | | BACK DIMENSIONS | |
|--------------------|----|----|-----------------|------|----|-----------------|----|
| W | D | H | W | D | H | W | H |
| 24.5 | 28 | 42 | 20.5 | 18.5 | 18 | 19 | 24 |

SAVANNAH



model GC4161



Armchair
COM Yardage: 2
Freight Class: 300
Product Weight (lbs.): 26
Cubic Feet Per Carton: 16.25

STANDARD FEATURES

- Picture frame style back and curves throughout the design will add an elegant look to any setting.
- Contoured arms with a firm grip extension assist users in the entry and exist from the chair.
- Additional leg support bars complement the leg frame and ensure strength and durability.
- For Globalcare textiles and wood finish options, visit the web site at www.thinkglobalcare.com. **Available in European Beech Wood Only (Refer to finishes that end with an "M").**
- This product is shipped fully assembled.

- Standard glide is plastic. For Non-slip glides specify (NS) - **Add \$21.00** list upcharge.
- Seat is made from Ultracell foam for added comfort. Moisture Barrier (Seat Only) - **Add \$85.00** list upcharge.
- For addition of a Fire Barrier Lining - **Add \$65.00** list upcharge per yard.
- Call Customer Service for **CAL133** approved textiles.

SUGGESTED APPLICATIONS

- Dining Rooms

GC4161

| COM | 2 | 3 | 4 | 5 | 6 | 7 | 8 | 9 | 10 | 11 | 12 |
|--------|--------|--------|--------|--------|--------|--------|--------|--------|--------|--------|--------|
| \$1270 | \$1314 | \$1419 | \$1475 | \$1553 | \$1584 | \$1654 | \$1784 | \$1850 | \$1971 | \$2140 | \$2140 |

| OVERALL DIMENSIONS | | | SEAT DIMENSIONS | | | BACK DIMENSIONS | |
|--------------------|----|------|-----------------|----|----|-----------------|----|
| W | D | H | W | D | H | W | H |
| 23.5 | 24 | 40.5 | 21 | 19 | 18 | 18.5 | 20 |

SENATOR



model GC3392

STANDARD FEATURES

- The flared back design and creative curves enhance any healthcare environment without sacrificing comfort.
- Seat cushions are easily removable for cleaning and protecting against bacteria.
- Seat cushions are made with Ultracell foam for added comfort.
- Standard with wood legs. Optional Metal legs are available in Black (BLK), Toast (TOA), Platinum (PLT), Tungsten (TUN), Cappuccino (T20), Mocha (J52), and Kalua (KAL) at no charge. Please Specify.
- For Globalcare textiles and wood finish options, visit the web site at www.thinkglobalcare.com. **Available in Maple Wood Only (Refer to finishes that end with an "M").**
- This product can be upholstered in standard Global textiles only if Healthcare compliance is not required.
- This product is shipped fully assembled.
- Standard glide is plastic. For Non-slip glides specify (NS) - **Add \$21.00** list upcharge.
- Moisture Barrier (Seat Only) - **Add \$127.00** list upcharge.
- For addition of a Fire Barrier Lining - **Add \$65.00** list upcharge per yard.

- Call Customer Service for **CAL133** approved textiles.

SUGGESTED APPLICATIONS

- Dining Rooms

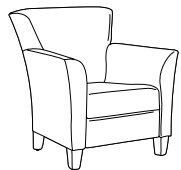

GC3391

Armchair
COM Yardage: 5.25
Freight Class: 250
Product Weight (lbs.): 66
Cubic Feet Per Carton: 28.50

| COM | 2 | 3 | 4 | 5 | 6 | 7 | 8 | 9 | 10 | 11 | 12 |
|--------|--------|--------|--------|--------|--------|--------|--------|--------|--------|--------|--------|
| \$1740 | \$1849 | \$2037 | \$2181 | \$2386 | \$2464 | \$2643 | \$2979 | \$3148 | \$3460 | \$3895 | \$3895 |

| OVERALL DIMENSIONS | | | SEAT DIMENSIONS | | | BACK DIMENSIONS | |
|--------------------|-------|----|-----------------|----|------|-----------------|------|
| W | D | H | W | D | H | W | H |
| 34 | 32.25 | 36 | 19.5 | 19 | 17.5 | 28 | 18.5 |

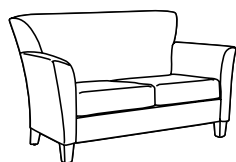

GC3392

Two Seat Sofa
COM Yardage: 8.25
Freight Class: 300
Product Weight (lbs.): 100
Cubic Feet Per Carton: 55.75

| COM | 2 | 3 | 4 | 5 | 6 | 7 | 8 | 9 | 10 | 11 | 12 |
|--------|--------|--------|--------|--------|--------|--------|--------|--------|--------|--------|--------|
| \$2449 | \$2620 | \$2902 | \$3129 | \$3451 | \$3572 | \$3854 | \$4382 | \$4647 | \$5139 | \$5823 | \$5823 |

| OVERALL DIMENSIONS | | | SEAT DIMENSIONS | | | BACK DIMENSIONS | |
|--------------------|-------|----|-----------------|----|------|-----------------|------|
| W | D | H | W | D | H | W | H |
| 61 | 32.25 | 36 | 46 | 19 | 17.5 | 56 | 18.5 |

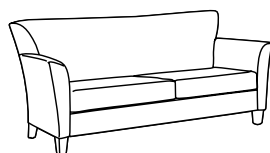

GC3393

Three Seat Sofa
COM Yardage: 9.50
Freight Class: 250
Product Weight (lbs.): 125
Cubic Feet Per Carton: 59.75

| COM | 2 | 3 | 4 | 5 | 6 | 7 | 8 | 9 | 10 | 11 | 12 |
|--------|--------|--------|--------|--------|--------|--------|--------|--------|--------|--------|--------|
| \$3164 | \$3358 | \$3702 | \$3963 | \$4333 | \$4474 | \$4797 | \$5406 | \$5711 | \$6277 | \$7063 | \$7063 |

| OVERALL DIMENSIONS | | | SEAT DIMENSIONS | | | BACK DIMENSIONS | |
|--------------------|-------|----|-----------------|----|------|-----------------|------|
| W | D | H | W | D | H | W | H |
| 76 | 32.25 | 36 | 61 | 19 | 17.5 | 71 | 18.5 |

STRAND



model GC3707HB



model GC3702

FEATURES

- The Strand Series is the perfect synthesis of versatility, comfort, durability and value pricing. Strand offers a pleasing look in a diverse range of solutions from single patient room chairs to waiting areas and public spaces.
- All models are standard in oval metal tube frame.
- Frame available in Black (BLK), Toast (TOA), Platinum (PLT), Tungsten (TUN), Cappuccino (T20), Mocha (J52), and Kalua (KAL). Please specify at time of order placement.
- The frame can be weighted and made with tamper proof fasteners for greater security in more challenging mental health spaces or correctional facilities.
- Armcaps are standard in Black (BLK) Self Skinned Urethane. Wood armcaps are also available in all GLOBALcare wood finishes. (Must be specified at time of order placement.)
Single Seat - Add \$118.00 list upcharge.
Two Seater - Add \$176.00 list upcharge.
Three Seater - Add \$235.00 list upcharge.
- Left and Right Position Reference is determined based on being seated in the chair.
- The seat and back are removable and field replaceable.
- All seats are standard with High Density Ultracell Bio Foam.
- All Seat Frames feature a wallsaver design. Ottomans and Benches do not have wallsaver legs.
- Standard seat height on all models is 18". Cleanout space is provided between the seat and back cushions for easier housekeeping and infection control.
- Select models are offered with casters on the rear legs. These casters allow for ease of movement in support of housekeeping efforts or repositioning seating within a space.
- To activate rear casters, tilt the chair back so the casters are in contact with the floor. This feature makes it easier to relocate the chair while unoccupied.
- Flex Back models allow the back to move in a soothing rocking motion.
- Standard with Black glides. Non-marking white glides also available. Specify WH - No Upcharge.
- Moisture Barrier (Seat Only) - Add \$85.00 list upcharge per seat. For Bariatric Models: Add \$131.00 list upcharge per seat.
- As an option, seams can be sealed to prevent penetration of fluids through the stitching. Contact Customer Care for approved textiles.
For Low Back Models - Add \$67.00 list upcharge per seat.
For Low Back Bariatric Models - Add \$72.00 list upcharge per seat.
For High Back Models - Add \$79.00 list upcharge per seat.
For High Back Bariatric Models - Add \$82.00 list upcharge per seat.
For Split-Back models - Add \$119.00 list upcharge.
For Ottoman - Add \$20.00 list upcharge.
For Single Seat Bench - Add \$27.00 list upcharge.
For Two Seat Bench - Add \$53.00 list upcharge.
For Three Seat Bench - Add \$79.00 list upcharge.
- Active weight capacity for standard single seat is 350 lbs. and 750 lbs for Bariatric Seating
- For Globalcare textiles and wood finish options, visit the web site at www.thinkglobalcare.com.
- This product can be upholstered in standard Global textiles if healthcare compliance is not required.
- For addition of a Fire Barrier Lining - Add \$65.00 list upcharge per yard.
- Call Customer Service for CAL133 approved textiles.
- For complementary tables, please refer to the GC-Belong Series Freestanding Tables. (NOT FOR USE with GC-Belong Table Bridges)

SUGGESTED APPLICATIONS

- Waiting Areas
 - Guest Seating
- Lobbies
 - Lounges
- Patient Rooms

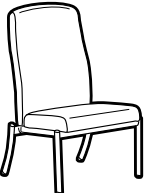
| DESCRIPTION | MODEL# | STANDARD FABRIC GRADES | | | | | | | | | | | |
|--|--------------------|------------------------|-------|-----------------|--------|--------|-----------------|--------|--------|--------|--------|--------|--------|
| | | COM | 2 | 3 | 4 | 5 | 6 | 7 | 8 | 9 | 10 | 11 | 12 |
|  <p>Low Back Single Seat Armless Chair COM Yardage: 1.75 Freight Class: 250 Product Weight (lbs.): 45 Cubic Feet Per Carton: 17.50</p> | GC3700 | \$803 | \$844 | \$877 | \$926 | \$995 | \$1023 | \$1083 | \$1198 | \$1254 | \$1361 | \$1509 | \$1509 |
| | OVERALL DIMENSIONS | | | SEAT DIMENSIONS | | | BACK DIMENSIONS | | | | | | |
| | W | D | H | W | D | H | W | H | | | | | |
| | 24.5 | 27.5 | 34.5 | 22 | 18.5 | 18 | 21.5 | 17 | | | | | |
|  <p>High Back Single Seat Armless Chair COM Yardage: 2 Freight Class: 250 Product Weight (lbs.): 53 Cubic Feet Per Carton: 20</p> | GC3700HB | \$950 | \$995 | \$1034 | \$1090 | \$1170 | \$1200 | \$1270 | \$1401 | \$1467 | \$1588 | \$1757 | \$1757 |
| | OVERALL DIMENSIONS | | | SEAT DIMENSIONS | | | BACK DIMENSIONS | | | | | | |
| | W | D | H | W | D | H | W | H | | | | | |
| | 24.5 | 27.5 | 42.5 | 22 | 18.5 | 18 | 21.5 | 25 | | | | | |

| DESCRIPTION | MODEL# | STANDARD FABRIC GRADES | | | | | | | | | | | |
|---|--------|--------------------------------|--------|--------|-----------------|--------|--------|-----------------|--------|--------|--------|--------|--------|
| | | COM | 2 | 3 | 4 | 5 | 6 | 7 | 8 | 9 | 10 | 11 | 12 |
|  <p>Low Back Single Seat Armchair COM Yardage: 1.75 Freight Class: 250 Product Weight (lbs.): 50 Cubic Feet Per Carton: 17.50</p> | GC3701 | \$960 | \$1001 | \$1034 | \$1083 | \$1152 | \$1179 | \$1240 | \$1355 | \$1411 | \$1518 | \$1666 | \$1666 |
| | | Wood armcap option - Add \$118 | | | | | | | | | | | |
| | | OVERALL DIMENSIONS | | | SEAT DIMENSIONS | | | BACK DIMENSIONS | | | | | |
| | | W | D | H | W | D | H | W | H | | | | |
| | | 25.5 | 27.5 | 34.5 | 22 | 18.5 | 18 | 21.5 | 17 | | | | |

| | | | | | | | | | | | | | |
|---|------------------------------|--------------------------------|--------|--------|-----------------|--------|--------|-----------------|--------|--------|--------|--------|--------|
|  <p>Low Back Armchair Post Surgery. Designed to immobilize the pelvis and hip joints after surgery. COM Yardage: 1.75 Freight Class: 250 Product Weight (lbs.): 53 Cubic Feet Per Carton: 17.50</p> | GC3701-24 24" seat height | \$1178 | \$1219 | \$1252 | \$1302 | \$1370 | \$1398 | \$1458 | \$1573 | \$1631 | \$1736 | \$1885 | \$1885 |
| | | Wood armcap option - Add \$118 | | | | | | | | | | | |
| | | OVERALL DIMENSIONS | | | SEAT DIMENSIONS | | | BACK DIMENSIONS | | | | | |
| | | W | D | H | W | D | H | W | H | | | | |
| | | 25.5 | 27.5 | 40.5 | 22 | 18.5 | 24 | 21.5 | 17 | | | | |

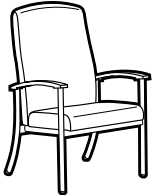
| | | | | | | | | | | | | | |
|---|----------|--------------------------------|--------|--------|-----------------|--------|--------|-----------------|--------|--------|--------|--------|--------|
|  <p>High Back Single Seat Armchair COM Yardage: 2 Freight Class: 250 Product Weight (lbs.): 55 Cubic Feet Per Carton: 20</p> | GC3701HB | \$1106 | \$1152 | \$1190 | \$1246 | \$1326 | \$1356 | \$1426 | \$1557 | \$1622 | \$1744 | \$1913 | \$1913 |
| | | Wood armcap option - Add \$118 | | | | | | | | | | | |
| | | OVERALL DIMENSIONS | | | SEAT DIMENSIONS | | | BACK DIMENSIONS | | | | | |
| | | W | D | H | W | D | H | W | H | | | | |
| | | 25.5 | 27.5 | 42.5 | 22 | 18.5 | 18 | 21.5 | 25 | | | | |

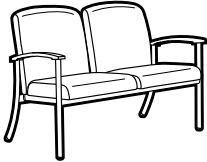
| | | | | | | | | | | | | | |
|---|--------|--------------------------------|--------|--------|-----------------|--------|--------|-----------------|--------|--------|--------|--------|--------|
|  <p>Low Back Two Seat Chair No Center Arm COM Yardage: 3.25 Freight Class: 300 Product Weight (lbs.): 70 Cubic Feet Per Carton: 45.75</p> | GC3702 | \$1515 | \$1590 | \$1652 | \$1743 | \$1872 | \$1921 | \$2034 | \$2246 | \$2353 | \$2551 | \$2826 | \$2826 |
| | | Wood armcap option - Add \$118 | | | | | | | | | | | |
| | | OVERALL DIMENSIONS | | | SEAT DIMENSIONS | | | BACK DIMENSIONS | | | | | |
| | | W | D | H | W | D | H | W | H | | | | |
| | | 49.75 | 27.5 | 34.5 | 44 | 18.5 | 18 | 43 | 17 | | | | |

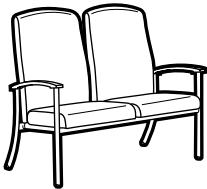
| | | | | | | | | | | | | | |
|--|----------|--------------------------------|--------|--------|-----------------|--------|--------|-----------------|--------|--------|--------|--------|--------|
|  <p>High Back Two Seat Chair No Center Arm COM Yardage: 3.75 Freight Class: 300 Product Weight (lbs.): 78 Cubic Feet Per Carton: 56.50</p> | GC3702HB | \$1746 | \$1831 | \$1903 | \$2008 | \$2157 | \$2214 | \$2344 | \$2590 | \$2713 | \$2941 | \$3258 | \$3258 |
| | | Wood armcap option - Add \$118 | | | | | | | | | | | |
| | | OVERALL DIMENSIONS | | | SEAT DIMENSIONS | | | BACK DIMENSIONS | | | | | |
| | | W | D | H | W | D | H | W | H | | | | |
| | | 49.75 | 27.5 | 42.5 | 44 | 18.5 | 18 | 43 | 25 | | | | |

SEATING

STRAND S

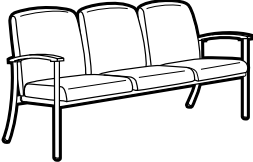
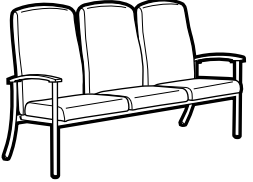
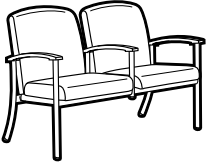
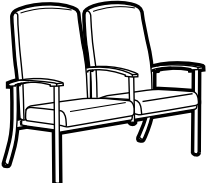
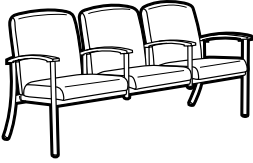
| DESCRIPTION | MODEL# | STANDARD FABRIC GRADES | | | | | | | | | | | |
|---|----------|---------------------------------------|--------|--------|------------------------|--------|--------|------------------------|--------|--------|--------|--------|--------|
| | | COM | 2 | 3 | 4 | 5 | 6 | 7 | 8 | 9 | 10 | 11 | 12 |
|  <p>Low Back Three Seat Chair No Center Arms COM Yardage: 4.50 Freight Class: 300 Product Weight (lbs.): 92 Cubic Feet Per Carton: 65.25</p> | GC3703 | \$2118 | \$2222 | \$2307 | \$2433 | \$2612 | \$2680 | \$2837 | \$3131 | \$3279 | \$3552 | \$3933 | \$3933 |
| | | OVERALL DIMENSIONS | | | SEAT DIMENSIONS | | | BACK DIMENSIONS | | | | | |
| | | W | D | H | W | D | H | W | H | | | | |
| | | | 71.25 | 27.5 | 34.5 | 66 | 18.5 | 18 | 64.5 | 17 | | | |
| | | Wood armcap option - Add \$118 | | | | | | | | | | | |
|  <p>High Back Three Seat Chair No Center Arms COM Yardage: 5.25 Freight Class: 300 Product Weight (lbs.): 100 Cubic Feet Per Carton: 80.75</p> | GC3703HB | \$2374 | \$2495 | \$2595 | \$2743 | \$2951 | \$3030 | \$3213 | \$3557 | \$3729 | \$4048 | \$4492 | \$4492 |
| | | OVERALL DIMENSIONS | | | SEAT DIMENSIONS | | | BACK DIMENSIONS | | | | | |
| | | W | D | H | W | D | H | W | H | | | | |
| | | | 71.25 | 27.5 | 42.5 | 66 | 18.5 | 18 | 64.5 | 25 | | | |
| | | Wood armcap option - Add \$118 | | | | | | | | | | | |
|  <p>Low Back Two Seat Chair Half Center Arm COM Yardage: 3.25 Freight Class: 300 Product Weight (lbs.): 75 Cubic Feet Per Carton: 45.75</p> | GC3704 | \$1676 | \$1751 | \$1812 | \$1904 | \$2033 | \$2082 | \$2195 | \$2408 | \$2514 | \$2712 | \$2987 | \$2987 |
| | | OVERALL DIMENSIONS | | | SEAT DIMENSIONS | | | BACK DIMENSIONS | | | | | |
| | | W | D | H | W | D | H | W | H | | | | |
| | | | 49.75 | 27.5 | 34.5 | 22 | 18.5 | 18 | 21.5 | 17 | | | |
| | | Wood armcap option - Add \$176 | | | | | | | | | | | |
|  <p>High Back Two Seat Chair Half Center Arm COM Yardage: 3.75 Freight Class: 300 Product Weight (lbs.): 83 Cubic Feet Per Carton: 56.50</p> | GC3704HB | \$1908 | \$1993 | \$2065 | \$2170 | \$2319 | \$2376 | \$2506 | \$2752 | \$2875 | \$3103 | \$3420 | \$3420 |
| | | OVERALL DIMENSIONS | | | SEAT DIMENSIONS | | | BACK DIMENSIONS | | | | | |
| | | W | D | H | W | D | H | W | H | | | | |
| | | | 49.75 | 27.5 | 42.5 | 22 | 18.5 | 18 | 21.5 | 25 | | | |
| | | Wood armcap option - Add \$176 | | | | | | | | | | | |
|  <p>Low Back Three Seat Chair Half Center Arms COM Yardage: 4.50 Freight Class: 300 Product Weight (lbs.): 102 Cubic Feet Per Carton: 65.25</p> | GC3705 | \$2440 | \$2545 | \$2630 | \$2756 | \$2935 | \$3003 | \$3159 | \$3454 | \$3602 | \$3875 | \$4256 | \$4256 |
| | | OVERALL DIMENSIONS | | | SEAT DIMENSIONS | | | BACK DIMENSIONS | | | | | |
| | | W | D | H | W | D | H | W | H | | | | |
| | | | 71.25 | 27.5 | 34.5 | 22 | 18.5 | 18 | 21.5 | 17 | | | |
| | | Wood armcap option - Add \$235 | | | | | | | | | | | |

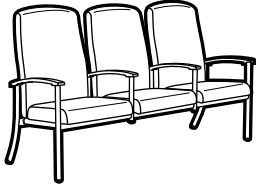
| DESCRIPTION | MODEL# | STANDARD FABRIC GRADES | | | | | | | | | | | |
|--|----------|------------------------|--------------------------------|--------|-----------------|--------|--------|-----------------|--------|--------|--------|--------|--------|
| | | COM | 2 | 3 | 4 | 5 | 6 | 7 | 8 | 9 | 10 | 11 | 12 |
|  High Back Three Seat Chair Half Center Arms COM Yardage: 5.25 Freight Class: 300 Product Weight (lbs.): 106 Cubic Feet Per Carton: 80.75 | GC3705HB | \$2697 | \$2818 | \$2918 | \$3065 | \$3273 | \$3353 | \$3536 | \$3880 | \$4051 | \$4371 | \$4815 | \$4815 |
| | | OVERALL DIMENSIONS | | | SEAT DIMENSIONS | | | BACK DIMENSIONS | | | | | |
| | | W | D | H | W | D | H | W | H | | | | |
| | | | 71.25 | 27.5 | 42.5 | 22 | 18.5 | 18 | 21.5 | 25 | | | |
| | | | Wood armcap option - Add \$235 | | | | | | | | | | |

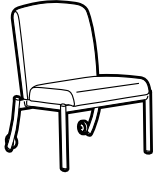
| DESCRIPTION | MODEL# | STANDARD FABRIC GRADES | | | | | | | | | | | |
|--|--------|------------------------|-------|-------|-----------------|--------|--------|-----------------|--------|--------|--------|--------|--------|
| | | COM | 2 | 3 | 4 | 5 | 6 | 7 | 8 | 9 | 10 | 11 | 12 |
|  Low Back Single Seat Armless Chair Casters COM Yardage: 1.75 Freight Class: 250 Product Weight (lbs.): 45 Cubic Feet Per Carton: 17.50 | GC3706 | \$901 | \$942 | \$975 | \$1025 | \$1094 | \$1121 | \$1181 | \$1296 | \$1353 | \$1459 | \$1608 | \$1608 |
| | | OVERALL DIMENSIONS | | | SEAT DIMENSIONS | | | BACK DIMENSIONS | | | | | |
| | | W | D | H | W | D | H | W | H | | | | |
| | | | 24.5 | 27.5 | 34.5 | 22 | 18.5 | 18 | 21.5 | 17 | | | |

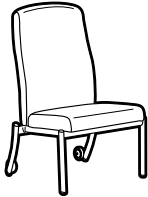
| DESCRIPTION | MODEL# | STANDARD FABRIC GRADES | | | | | | | | | | | |
|--|----------|------------------------|--------|--------|-----------------|--------|--------|-----------------|--------|--------|--------|--------|--------|
| | | COM | 2 | 3 | 4 | 5 | 6 | 7 | 8 | 9 | 10 | 11 | 12 |
|  High Back Single Seat Armless Chair Casters COM Yardage: 2 Freight Class: 250 Product Weight (lbs.): 53 Cubic Feet Per Carton: 20 | GC3706HB | \$1049 | \$1094 | \$1132 | \$1189 | \$1268 | \$1298 | \$1368 | \$1499 | \$1565 | \$1686 | \$1855 | \$1855 |
| | | OVERALL DIMENSIONS | | | SEAT DIMENSIONS | | | BACK DIMENSIONS | | | | | |
| | | W | D | H | W | D | H | W | H | | | | |
| | | | 24.5 | 27.5 | 42.5 | 22 | 18.5 | 18 | 21.5 | 25 | | | |

| DESCRIPTION | MODEL# | STANDARD FABRIC GRADES | | | | | | | | | | | |
|---|--------|------------------------|--------------------------------|--------|-----------------|--------|--------|-----------------|--------|--------|--------|--------|--------|
| | | COM | 2 | 3 | 4 | 5 | 6 | 7 | 8 | 9 | 10 | 11 | 12 |
|  Low Back Single Seat Armchair Casters COM Yardage: 1.75 Freight Class: 250 Product Weight (lbs.): 50 Cubic Feet Per Carton: 17.50 | GC3707 | \$1059 | \$1100 | \$1133 | \$1182 | \$1251 | \$1279 | \$1339 | \$1454 | \$1511 | \$1617 | \$1766 | \$1766 |
| | | OVERALL DIMENSIONS | | | SEAT DIMENSIONS | | | BACK DIMENSIONS | | | | | |
| | | W | D | H | W | D | H | W | H | | | | |
| | | | 25.5 | 27.5 | 34.5 | 22 | 18.5 | 18 | 21.5 | 17 | | | |
| | | | Wood armcap option - Add \$118 | | | | | | | | | | |

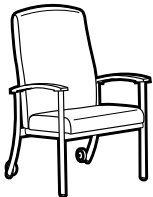
| DESCRIPTION | MODEL# | STANDARD FABRIC GRADES | | | | | | | | | | | |
|--|----------|------------------------|--------------------------------|--------|-----------------|--------|--------|-----------------|--------|--------|--------|--------|--------|
| | | COM | 2 | 3 | 4 | 5 | 6 | 7 | 8 | 9 | 10 | 11 | 12 |
|  High Back Single Seat Armchair Casters COM Yardage: 2 Freight Class: 250 Product Weight (lbs.): 52 Cubic Feet Per Carton: 20 | GC3707HB | \$1205 | \$1250 | \$1289 | \$1345 | \$1425 | \$1455 | \$1525 | \$1656 | \$1722 | \$1843 | \$2012 | \$2012 |
| | | OVERALL DIMENSIONS | | | SEAT DIMENSIONS | | | BACK DIMENSIONS | | | | | |
| | | W | D | H | W | D | H | W | H | | | | |
| | | | 25.5 | 27.5 | 42.5 | 22 | 18.5 | 18 | 21.5 | 25 | | | |
| | | | Wood armcap option - Add \$118 | | | | | | | | | | |

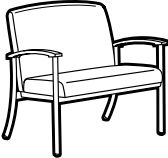
| DESCRIPTION | MODEL# | STANDARD FABRIC GRADES | | | | | | | | | | | |
|---|--------|------------------------|--------|--------|-----------------|--------|--------|-----------------|--------|--------|--------|--------|--------|
| | | COM | 2 | 3 | 4 | 5 | 6 | 7 | 8 | 9 | 10 | 11 | 12 |
|  <p>Bariatric Low Back Armchair COM Yardage: 2.75 Freight Class: 250 Product Weight (lbs.): 62 Cubic Feet Per Carton: 26.50</p> | GC3711 | \$1211 | \$1275 | \$1327 | \$1404 | \$1514 | \$1555 | \$1651 | \$1831 | \$1921 | \$2088 | \$2321 | \$2321 |
| | | OVERALL DIMENSIONS | | | SEAT DIMENSIONS | | | BACK DIMENSIONS | | | | | |
| | | W | D | H | W | D | H | W | H | | | | |
| | | | 36 | 27.5 | 34.5 | 32.5 | 18.5 | 18 | 31 | 17 | | | |

Wood armcap option - **Add \$118**
 • For users up to 750 lbs.
 Armless Bariatric models are not available.

| | | | | | | | | | | | | | |
|--|------------------------------|--------------------|--------|--------|-----------------|--------|--------|-----------------|--------|--------|--------|--------|--------|
|  <p>Bariatric Low Back Armchair Post Surgery. Designed to immobilize the pelvis and hip joints after surgery COM Yardage: 2.75 Freight Class: 250 Product Weight (lbs.): 63 Cubic Feet Per Carton: 30.50</p> | GC3711-24 24" seat height | \$1412 | \$1476 | \$1528 | \$1606 | \$1714 | \$1756 | \$1852 | \$2032 | \$2122 | \$2289 | \$2522 | \$2522 |
| | | OVERALL DIMENSIONS | | | SEAT DIMENSIONS | | | BACK DIMENSIONS | | | | | |
| | | W | D | H | W | D | H | W | H | | | | |
| | | | 36 | 27.5 | 40.5 | 32.5 | 18.5 | 24 | 31 | 17 | | | |

Wood armcap option - **Add \$118**
 • For users up to 750 lbs.
 Armless Bariatric models are not available.

| | | | | | | | | | | | | | |
|---|----------|--------------------|--------|--------|-----------------|--------|--------|-----------------|--------|--------|--------|--------|--------|
|  <p>Bariatric High Back Armchair COM Yardage: 3.25 Freight Class: 250 Product Weight (lbs.): 68 Cubic Feet Per Carton: 30.50</p> | GC3711HB | \$1342 | \$1418 | \$1479 | \$1570 | \$1700 | \$1748 | \$1862 | \$2074 | \$2180 | \$2379 | \$2653 | \$2653 |
| | | OVERALL DIMENSIONS | | | SEAT DIMENSIONS | | | BACK DIMENSIONS | | | | | |
| | | W | D | H | W | D | H | W | H | | | | |
| | | | 36 | 27.5 | 42.5 | 32.5 | 18.5 | 18 | 31 | 25 | | | |

Wood armcap option - **Add \$118**
 • For users up to 750 lbs.
 Armless Bariatric models are not available.

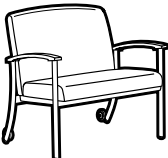
| | | | | | | | | | | | | | |
|---|--------|--------------------|--------|--------|-----------------|--------|--------|-----------------|--------|--------|--------|--------|--------|
|  <p>Bariatric Low Back Armchair Casters COM Yardage: 2.75 Freight Class: 250 Product Weight (lbs.): 62 Cubic Feet Per Carton: 26.50</p> | GC3712 | \$1311 | \$1374 | \$1427 | \$1504 | \$1613 | \$1655 | \$1750 | \$1931 | \$2020 | \$2188 | \$2421 | \$2421 |
| | | OVERALL DIMENSIONS | | | SEAT DIMENSIONS | | | BACK DIMENSIONS | | | | | |
| | | W | D | H | W | D | H | W | H | | | | |
| | | | 36 | 27.5 | 34.5 | 32.5 | 18.5 | 18 | 31 | 17 | | | |

Wood armcap option - **Add \$118**
 • For users up to 750 lbs.
 Armless Bariatric models are not available.

| | | | | | | | | | | | | | |
|--|----------|--------------------|--------|--------|-----------------|--------|--------|-----------------|--------|--------|--------|--------|--------|
|  <p>Bariatric High Back Armchair Casters COM Yardage: 3.25 Freight Class: 250 Product Weight (lbs.): 68 Cubic Feet Per Carton: 30.50</p> | GC3712HB | \$1441 | \$1516 | \$1577 | \$1668 | \$1798 | \$1847 | \$1960 | \$2172 | \$2279 | \$2477 | \$2752 | \$2752 |
| | | OVERALL DIMENSIONS | | | SEAT DIMENSIONS | | | BACK DIMENSIONS | | | | | |
| | | W | D | H | W | D | H | W | H | | | | |
| | | | 36 | 27.5 | 42.5 | 32.5 | 18.5 | 18 | 31 | 25 | | | |

Wood armcap option - **Add \$118**
 • For users up to 750 lbs.
 Armless Bariatric models are not available.

| DESCRIPTION | MODEL# | STANDARD FABRIC GRADES | | | | | | | | | | | |
|---|--------|------------------------|--------------------------------|--------|-----------------|--------|--------|-----------------|--------|--------|--------|--------|--------|
| | | COM | 2 | 3 | 4 | 5 | 6 | 7 | 8 | 9 | 10 | 11 | 12 |
|  <p>Low Back Single Seat Armchair Flex Back COM Yardage: 1.75 Freight Class: 250 Product Weight (lbs.): 50 Cubic Feet Per Carton: 17.50</p> | GC3715 | \$1142 | \$1182 | \$1216 | \$1265 | \$1334 | \$1361 | \$1422 | \$1537 | \$1593 | \$1700 | \$1848 | \$1848 |
| | | OVERALL DIMENSIONS | | | SEAT DIMENSIONS | | | BACK DIMENSIONS | | | | | |
| | | W | D | H | W | D | H | W | H | | | | |
| | | | 25.5 | 27.5 | 34.5 | 22 | 18.5 | 18 | 21.5 | 17 | | | |
| | | | Wood armcap option - Add \$118 | | | | | | | | | | |

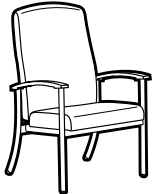
| | | | | | | | | | | | | | |
|--|----------|--------------------|--------------------------------|--------|-----------------|--------|--------|-----------------|--------|--------|--------|--------|--------|
|  <p>High Back Single Seat Armchair Flex Back COM Yardage: 2 Freight Class: 250 Product Weight (lbs.): 52 Cubic Feet Per Carton: 20</p> | GC3715HB | \$1289 | \$1334 | \$1373 | \$1429 | \$1508 | \$1539 | \$1609 | \$1739 | \$1805 | \$1926 | \$2096 | \$2096 |
| | | OVERALL DIMENSIONS | | | SEAT DIMENSIONS | | | BACK DIMENSIONS | | | | | |
| | | W | D | H | W | D | H | W | H | | | | |
| | | | 25.5 | 27.5 | 42.5 | 22 | 18.5 | 18 | 21.5 | 25 | | | |
| | | | Wood armcap option - Add \$118 | | | | | | | | | | |

| | | | | | | | | | | | | | |
|---|--------|--------------------|--------------------------------|--------|-----------------|--------|--------|-----------------|--------|--------|--------|--------|--------|
|  <p>Low Back Single Seat Armchair Flex Back, Casters COM Yardage: 1.75 Freight Class: 250 Product Weight (lbs.): 50 Cubic Feet Per Carton: 17.50</p> | GC3716 | \$1240 | \$1281 | \$1314 | \$1363 | \$1432 | \$1459 | \$1520 | \$1635 | \$1691 | \$1798 | \$1946 | \$1946 |
| | | OVERALL DIMENSIONS | | | SEAT DIMENSIONS | | | BACK DIMENSIONS | | | | | |
| | | W | D | H | W | D | H | W | H | | | | |
| | | | 25.5 | 27.5 | 34.5 | 22 | 18.5 | 18 | 21.5 | 17 | | | |
| | | | Wood armcap option - Add \$118 | | | | | | | | | | |

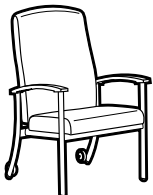
| | | | | | | | | | | | | | |
|---|----------|--------------------|--------------------------------|--------|-----------------|--------|--------|-----------------|--------|--------|--------|--------|--------|
|  <p>High Back Single Seat Armchair Flex Back, Casters COM Yardage: 2 Freight Class: 250 Product Weight (lbs.): 52 Cubic Feet Per Carton: 20</p> | GC3716HB | \$1387 | \$1432 | \$1471 | \$1527 | \$1607 | \$1637 | \$1707 | \$1838 | \$1903 | \$2025 | \$2194 | \$2194 |
| | | OVERALL DIMENSIONS | | | SEAT DIMENSIONS | | | BACK DIMENSIONS | | | | | |
| | | W | D | H | W | D | H | W | H | | | | |
| | | | 25.5 | 27.5 | 42.5 | 22 | 18.5 | 18 | 21.5 | 25 | | | |
| | | | Wood armcap option - Add \$118 | | | | | | | | | | |

| | | | | | | | | | | | | | |
|---|----------|--------------------|--------------------------------|--------|-----------------|--------|--------|-----------------|--------|--------|--------|--------|--------|
|  <p>High Back Single Seat Armchair Split Back COM Yardage: 2 Freight Class: 250 Product Weight (lbs.): 55 Cubic Feet Per Carton: 20</p> | GC3717HB | \$1297 | \$1343 | \$1381 | \$1437 | \$1517 | \$1547 | \$1616 | \$1748 | \$1814 | \$1935 | \$2104 | \$2104 |
| | | OVERALL DIMENSIONS | | | SEAT DIMENSIONS | | | BACK DIMENSIONS | | | | | |
| | | W | D | H | W | D | H | W | H | | | | |
| | | | 25.5 | 27.5 | 42.5 | 22 | 18.5 | 18 | 21.5 | 25 | | | |
| | | | Wood armcap option - Add \$118 | | | | | | | | | | |

| DESCRIPTION | MODEL# | STANDARD FABRIC GRADES | | | | | | | | | | | |
|--|----------|------------------------------------|--------|--------|---------------------------------|--------|--------|-------------------------------|--------|--------|--------|--------|--------|
| | | COM | 2 | 3 | 4 | 5 | 6 | 7 | 8 | 9 | 10 | 11 | 12 |
|  <p>High Back Single Seat Armchair Split Back, Casters COM Yardage: 2 Freight Class: 250 Product Weight (lbs.): 55 Cubic Feet Per Carton: 20</p> | GC3718HB | \$1396 | \$1442 | \$1479 | \$1536 | \$1615 | \$1645 | \$1715 | \$1846 | \$1912 | \$2033 | \$2202 | \$2202 |
| | | OVERALL DIMENSIONS W D H | | | SEAT DIMENSIONS W D H | | | BACK DIMENSIONS W H | | | | | |
| | | 25.5 | 27.5 | 42.5 | 22 | 18.5 | 18 | 21.5 | 25 | | | | |

Wood armcap option - Add \$118

| | | | | | | | | | | | | | |
|---|--------|------------------------------------|-------|-------|---------------------------------|-------|-------|-------------------------------|-------|-------|-------|--------|--------|
|  <p>Ottoman Angled cushion top. COM Yardage: 1 Freight Class: 150 Product Weight (lbs.): 17 Cubic Feet Per Carton: 3.50</p> | GC3708 | COM | 2 | 3 | 4 | 5 | 6 | 7 | 8 | 9 | 10 | 11 | 12 |
| | | \$607 | \$630 | \$648 | \$677 | \$716 | \$732 | \$766 | \$832 | \$865 | \$925 | \$1010 | \$1010 |
| | | OVERALL DIMENSIONS W D H | | | SEAT DIMENSIONS W D H | | | BACK DIMENSIONS W H | | | | | |
| | | 16.5 | 18.5 | 10.5 | | | | | | | | | |

Stores beneath any standard seating unit.

| | | | | | | | | | | | | | |
|---|--------|------------------------------------|-------|-------|---------------------------------|-------|-------|-------------------------------|-------|--------|--------|--------|--------|
|  <p>Single Seat Bench COM Yardage: 1.25 Freight Class: 250 Product Weight (lbs.): 27 Cubic Feet Per Carton: 8.50</p> | GC3721 | COM | 2 | 3 | 4 | 5 | 6 | 7 | 8 | 9 | 10 | 11 | 12 |
| | | \$679 | \$707 | \$731 | \$765 | \$816 | \$834 | \$878 | \$960 | \$1001 | \$1077 | \$1182 | \$1182 |
| | | OVERALL DIMENSIONS W D H | | | SEAT DIMENSIONS W D H | | | BACK DIMENSIONS W H | | | | | |
| | | 24.75 | 23.5 | 18 | | | | | | | | | |

| | | | | | | | | | | | | | |
|---|--------|------------------------------------|--------|--------|---------------------------------|--------|--------|-------------------------------|--------|--------|--------|--------|--------|
|  <p>Two Seat Bench COM Yardage: 1.75 Freight Class: 250 Product Weight (lbs.): 50 Cubic Feet Per Carton: 23</p> | GC3722 | COM | 2 | 3 | 4 | 5 | 6 | 7 | 8 | 9 | 10 | 11 | 12 |
| | | \$1020 | \$1061 | \$1095 | \$1144 | \$1213 | \$1240 | \$1300 | \$1415 | \$1472 | \$1578 | \$1727 | \$1727 |
| | | OVERALL DIMENSIONS W D H | | | SEAT DIMENSIONS W D H | | | BACK DIMENSIONS W H | | | | | |
| | | 47.5 | 23.5 | 18 | | | | | | | | | |

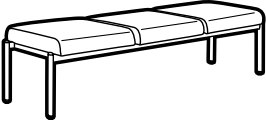
| | | | | | | | | | | | | | |
|---|--------|------------------------------------|--------|--------|---------------------------------|--------|--------|-------------------------------|--------|--------|--------|--------|--------|
|  <p>Three Seat Bench COM Yardage: 2 Freight Class: 250 Product Weight (lbs.): 70 Cubic Feet Per Carton: 33.25</p> | GC3723 | COM | 2 | 3 | 4 | 5 | 6 | 7 | 8 | 9 | 10 | 11 | 12 |
| | | \$1330 | \$1376 | \$1413 | \$1470 | \$1549 | \$1579 | \$1650 | \$1780 | \$1846 | \$1967 | \$2136 | \$2136 |
| | | OVERALL DIMENSIONS W D H | | | SEAT DIMENSIONS W D H | | | BACK DIMENSIONS W H | | | | | |
| | | 70 | 23.5 | 18 | | | | | | | | | |

WELLNESS



model GC3707HB

Soft Seat Cushion



Provides continuous comfort to the user. Available on all models. Specify **GCCC** - Add \$9

Extra Thick Seat Cushion



Great for users who require a more firm seat. Available on all models. Specify **GCG** - Add \$17

Seat Angle Adjustment



Three position seat angle adjustment is available on models GC7530-21, GC7530-23, and GC7530. Specify **U** - Add \$126

Back Angle Adjustment



Four position back angle adjustment is available on models GC7530-21 and GC7530-23. Specify **V** - Add \$212

FEATURES

- The variety of models offered within this series make it the most appropriate for healthcare applications.
- The radius front edge on the seat cushion promotes good lower leg circulation.
- Wood frames are available in a variety of finishes. For a complete listing of Globalcare textiles and wood seating finishes visit the web site at www.thinkglobalcare.com. **Available in Maple and Oak wood.**
- Standard glide is plastic. For Non-slip glides specify **(NS)** - Add \$21.00 list upcharge. (Not available on model GC7511-21)
- Soft seat cushion provides continuous comfort to the user. Available on all models. Specify **GCCC** - Add \$9.00
- Extra thick seat cushion is great for users that require a more firm seat. Available on all models. Specify **GCG** - Add \$17.00.
- Three position seat angle adjustment is available on models GC7530-21 and GC7530-23. Specify **(U)** - Add \$126.00.
- Four position back angle adjustment is available on models GC7530-21 and GC7530-23. Specify **(V)** - Add \$212.00.
- Three position adjustable reverse seat

mechanism is available on models GC7530-21 and GC7530-23. Specify **(RU)** - Add \$126.00.

- Seats are self-draining and cushions are removable for easy clean up. The non-rust nylon zippered cover facilitates easy maintenance. **Moisture Barrier (Seat Only)** - Add \$85.00 list upcharge per seat.
- For addition of a Fire Barrier Lining - Add \$65.00 list upcharge per yard.
- Call Customer Service for **CAL133** approved textiles.

SUGGESTED APPLICATIONS

- Dining Rooms
- Patient Rooms
- Resident Rooms

DESCRIPTION MODEL# STANDARD FABRIC GRADES

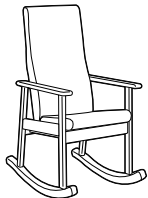

GC7511-21

| COM | 2 | 3 | 4 | 5 | 6 | 7 | 8 | 9 | 10 | 11 | 12 |
|--------|--------|--------|--------|--------|--------|--------|--------|--------|--------|--------|--------|
| \$1124 | \$1182 | \$1229 | \$1300 | \$1399 | \$1437 | \$1524 | \$1687 | \$1769 | \$1921 | \$2133 | \$2133 |

| OVERALL DIMENSIONS | | | SEAT DIMENSIONS | | | BACK DIMENSIONS | |
|--------------------|----|----|-----------------|----|------|-----------------|----|
| W | D | H | W | D | H | W | H |
| 25.5 | 32 | 46 | 19 | 18 | 15.5 | 19 | 30 |

High Back Rocking Chair
COM Yardage: 2.50
Freight Class: 250
Product Weight (lbs.): 37
Cubic Feet Per Carton: 15.38

• Non-Slip glides (NS) are NOT available.

2 per carton. Specifications and pricing are for 1 chair.

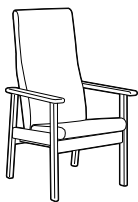

GC7530-21

| COM | 2 | 3 | 4 | 5 | 6 | 7 | 8 | 9 | 10 | 11 | 12 |
|-------|-------|--------|--------|--------|--------|--------|--------|--------|--------|--------|--------|
| \$939 | \$997 | \$1044 | \$1115 | \$1214 | \$1252 | \$1339 | \$1502 | \$1584 | \$1736 | \$1948 | \$1948 |

| OVERALL DIMENSIONS | | | SEAT DIMENSIONS | | | BACK DIMENSIONS | |
|--------------------|----|----|-----------------|------|----|-----------------|----|
| W | D | H | W | D | H | W | H |
| 25.5 | 27 | 48 | 19 | 17.5 | 18 | 19 | 30 |

High Back Armchair
COM Yardage: 2.50
Freight Class: 250
Product Weight (lbs.): 42
Cubic Feet Per Carton: 13.75

2 per carton. Specifications and pricing are for 1 chair.

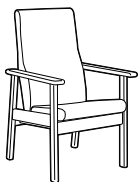

GC7530-23

| COM | 2 | 3 | 4 | 5 | 6 | 7 | 8 | 9 | 10 | 11 | 12 |
|-------|-------|-------|--------|--------|--------|--------|--------|--------|--------|--------|--------|
| \$890 | \$930 | \$963 | \$1012 | \$1082 | \$1108 | \$1169 | \$1284 | \$1341 | \$1448 | \$1596 | \$1596 |

| OVERALL DIMENSIONS | | | SEAT DIMENSIONS | | | BACK DIMENSIONS | |
|--------------------|----|----|-----------------|------|----|-----------------|----|
| W | D | H | W | D | H | W | H |
| 25.5 | 27 | 36 | 19 | 17.5 | 18 | 19 | 18 |

Low Back Armchair
COM Yardage: 1.75
Freight Class: 250
Product Weight (lbs.): 36
Cubic Feet Per Carton: 13.75

2 per carton. Specifications and pricing are for 1 chair.

DESCRIPTION

MODEL#

STANDARD FABRIC GRADES

| COM | 2 | 3 | 4 | 5 | 6 | 7 | 8 | 9 | 10 | 11 | 12 |
|-------|-------|-------|-------|-------|-------|-------|-------|-------|-------|-------|-------|
| \$486 | \$505 | \$549 | \$577 | \$617 | \$633 | \$666 | \$729 | \$763 | \$821 | \$905 | \$905 |

GC7537

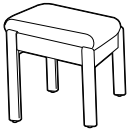

Ottoman Angled top.
 COM Yardage: 1
 Freight Class: 250
 Product Weight (lbs.): 12.50
 Cubic Feet Per Carton: 4.13

2 per carton. Specifications and pricing are for 1 chair.

OVERALL DIMENSIONS

W D H

22.5 17.5 17

SEAT DIMENSIONS

W D H

BACK DIMENSIONS

W H

| COM | 2 | 3 | 4 | 5 | 6 | 7 | 8 | 9 | 10 | 11 | 12 |
|------|-------|-------|-------|-------|-------|-------|-------|-------|-------|-------|-------|
| \$89 | \$106 | \$121 | \$142 | \$171 | \$183 | \$209 | \$258 | \$282 | \$328 | \$392 | \$392 |

GC-M

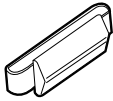

Neck Cushion for Wellness series models.
 COM Yardage: .75
 Freight Class: 70
 Product Weight (lbs.): 1.50
 Cubic Feet Per Carton: .50

2 per carton. Specifications and pricing are for 1 chair.

OVERALL DIMENSIONS

W D H

19 2.5 8

SEAT DIMENSIONS

W D H

BACK DIMENSIONS

W H

WINGBACK



model GC3787C

STANDARD FEATURES

- Traditional styling and details combined with modern health care function.
- All products are supportive, easy to exit, self-draining and feature removable and replaceable seats.
- Wood frame and legs in a variety of finishes. **Available in Maple wood Only.**
- For Globalcare textiles and wood finish options, visit the web site at www.thinkglobalcare.com.
- This product can be upholstered in standard Global textiles only if Healthcare compliance is not required.

- This product is shipped fully assembled.
- Standard glide is plastic. For Non-slip glides specify (NS) - **Add \$21.00** list upcharge.
- Seat is made from Ultracell foam for added comfort. Moisture Barrier (Seat Only) - **Add \$127.00** list upcharge.

SUGGESTED APPLICATIONS

- Waiting Areas
- Lobbies
- Resident Rooms
- Lounges
- Guest Seating

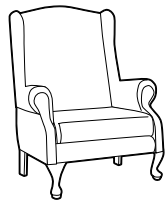

GC3787

| COM | 2 | 3 | 4 | 5 | 6 | 7 | 8 | 9 | 10 | 11 | 12 |
|--------|--------|--------|--------|--------|--------|--------|--------|--------|--------|--------|--------|
| \$1166 | \$1262 | \$1414 | \$1544 | \$1729 | \$1798 | \$1962 | \$2266 | \$2419 | \$2700 | \$3094 | \$3094 |

High Back Armchair Queen Anne Legs
COM Yardage: 4.75
Freight Class: 250
Product Weight (lbs.): 50
Cubic Feet Per Carton: 22.25

Loose seat cushion.

| OVERALL DIMENSIONS | | | SEAT DIMENSIONS | | | BACK DIMENSIONS | |
|--------------------|----|----|-----------------|----|------|-----------------|----|
| W | D | H | W | D | H | W | H |
| 29 | 30 | 39 | 19.5 | 18 | 17.5 | 19.5 | 22 |

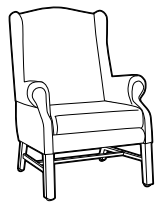

GC3787C

| COM | 2 | 3 | 4 | 5 | 6 | 7 | 8 | 9 | 10 | 11 | 12 |
|--------|--------|--------|--------|--------|--------|--------|--------|--------|--------|--------|--------|
| \$1182 | \$1281 | \$1433 | \$1563 | \$1748 | \$1818 | \$1980 | \$2286 | \$2436 | \$2717 | \$3111 | \$3111 |

High Back Armchair Chippendale Legs
COM Yardage: 4.75
Freight Class: 250
Product Weight (lbs.): 50
Cubic Feet Per Carton: 22.25

Loose seat cushion.

| OVERALL DIMENSIONS | | | SEAT DIMENSIONS | | | BACK DIMENSIONS | |
|--------------------|----|----|-----------------|----|------|-----------------|----|
| W | D | H | W | D | H | W | H |
| 29 | 30 | 39 | 19.5 | 18 | 17.5 | 19.5 | 22 |

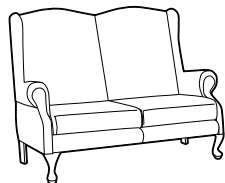

GC3788

| COM | 2 | 3 | 4 | 5 | 6 | 7 | 8 | 9 | 10 | 11 | 12 |
|--------|--------|--------|--------|--------|--------|--------|--------|--------|--------|--------|--------|
| \$1532 | \$1683 | \$1805 | \$1988 | \$2246 | \$2344 | \$2570 | \$2996 | \$3209 | \$3604 | \$4154 | \$4154 |

High Back Two Seat Sofa Queen Anne Legs
COM Yardage: 6.50
Freight Class: 300
Product Weight (lbs.): 64
Cubic Feet Per Carton: 41.50

Loose seat cushions.

| OVERALL DIMENSIONS | | | SEAT DIMENSIONS | | | BACK DIMENSIONS | |
|--------------------|----|------|-----------------|----|------|-----------------|----|
| W | D | H | W | D | H | W | H |
| 52 | 30 | 41.5 | 42 | 18 | 17.5 | 42 | 24 |

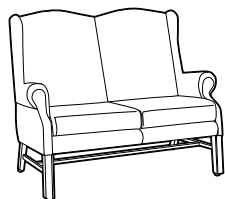

GC3788C

| COM | 2 | 3 | 4 | 5 | 6 | 7 | 8 | 9 | 10 | 11 | 12 |
|--------|--------|--------|--------|--------|--------|--------|--------|--------|--------|--------|--------|
| \$2102 | \$2254 | \$2376 | \$2559 | \$2817 | \$2915 | \$3141 | \$3567 | \$3780 | \$4175 | \$4725 | \$4725 |

High Back Two Seat Sofa Chippendale Legs
COM Yardage: 6.50
Freight Class: 300
Product Weight (lbs.): 64
Cubic Feet Per Carton: 41.50

Loose seat cushions.

| OVERALL DIMENSIONS | | | SEAT DIMENSIONS | | | BACK DIMENSIONS | |
|--------------------|----|------|-----------------|----|------|-----------------|----|
| W | D | H | W | D | H | W | H |
| 52 | 30 | 41.5 | 42 | 18 | 17.5 | 42 | 24 |

YORK



model GC7520-21

Seat Angle Adjustment



Three position seat angle adjustment is available on models GC7520-21, GC7520-23, GC7523-21 and GC7523-23. Specify **U** - Add \$126

Back Angle Adjustment



Four position back angle adjustment is available on models GC7520-21 and GC7520-23. Specify **V** - Add \$212

FEATURES

- Designed to give the user correct positioning and support to promote proper body alignment.
- Seats are self-draining and cushions are removable for easy clean up.
- Wood frames are available in a variety of finishes. For a complete listing of Globalcare textiles and wood seating finishes visit the web site at www.thinkglobalcare.com. **Available in Maple and Oak wood.**
- Coordinating tables with contoured legs are available. See pages 52-53.
- Standard glide is plastic. For Non-slip glides specify **(NS)** - Add \$21.00 list upcharge. (Not available on models GC7523-21 and GC7523-23.)
- Three position seat angle adjustment is available on models GC7520-21, GC7520-23, GC7523-21 and GC7523-23. Specify **(U)** - Add \$126.00.
- Four position back angle adjustment is available on models GC7520-21 and GC7520-23. Specify **(V)** - Add \$212.00.
- Three position adjustable reverse seat mechanism is available on models GC7520-21, GC7520-23, GC7523-21 and GC7523-23. Specify **(RU)** - Add \$126.00.

list upcharge per seat.

- For addition of a Fire Barrier Lining - Add \$65.00 list upcharge per yard.
- Call Customer Service for **CAL133** approved textiles.

SUGGESTED APPLICATIONS

- Dining Rooms
- Patient Rooms
- Resident Rooms

- High density Ultracell foam is standard. **Moisture Barrier (Seat Only)** - Add \$85.00

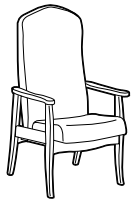

GC7520-21

| COM | 2 | 3 | 4 | 5 | 6 | 7 | 8 | 9 | 10 | 11 | 12 |
|--------|--------|--------|--------|--------|--------|--------|--------|--------|--------|--------|--------|
| \$1072 | \$1130 | \$1177 | \$1248 | \$1347 | \$1385 | \$1472 | \$1635 | \$1717 | \$1869 | \$2081 | \$2081 |

High Back Armchair

COM Yardage: 2.50
Freight Class: 250
Product Weight (lbs.): 32
Cubic Feet Per Carton: 13.75

2 per carton. Specifications and pricing are for 1 chair.

| OVERALL DIMENSIONS | | | SEAT DIMENSIONS | | | BACK DIMENSIONS | |
|--------------------|----|----|-----------------|----|----|-----------------|----|
| W | D | H | W | D | H | W | H |
| 25.5 | 28 | 48 | 19.5 | 18 | 18 | 18 | 30 |

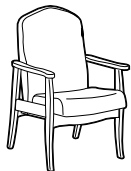

GC7520-23

| COM | 2 | 3 | 4 | 5 | 6 | 7 | 8 | 9 | 10 | 11 | 12 |
|--------|--------|--------|--------|--------|--------|--------|--------|--------|--------|--------|--------|
| \$1019 | \$1054 | \$1140 | \$1188 | \$1256 | \$1281 | \$1341 | \$1453 | \$1509 | \$1614 | \$1759 | \$1759 |

Low Back Armchair

COM Yardage: 1.75
Freight Class: 250
Product Weight (lbs.): 31
Cubic Feet Per Carton: 13.75

2 per carton. Specifications and pricing are for 1 chair.

| OVERALL DIMENSIONS | | | SEAT DIMENSIONS | | | BACK DIMENSIONS | |
|--------------------|----|------|-----------------|----|----|-----------------|----|
| W | D | H | W | D | H | W | H |
| 25.5 | 28 | 37.5 | 19.5 | 18 | 18 | 18 | 20 |

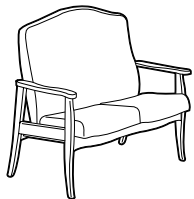

GC7520-2

| COM | 2 | 3 | 4 | 5 | 6 | 7 | 8 | 9 | 10 | 11 | 12 |
|--------|--------|--------|--------|--------|--------|--------|--------|--------|--------|--------|--------|
| \$1672 | \$1750 | \$1906 | \$2011 | \$2155 | \$2211 | \$2339 | \$2579 | \$2699 | \$2922 | \$3233 | \$3233 |

Medium Back Two Seat Sofa

COM Yardage: 3.75
Freight Class: 300
Product Weight (lbs.): 55
Cubic Feet Per Carton: 41.50

| OVERALL DIMENSIONS | | | SEAT DIMENSIONS | | | BACK DIMENSIONS | |
|--------------------|----|------|-----------------|------|------|-----------------|----|
| W | D | H | W | D | H | W | H |
| 44.5 | 28 | 42.5 | 39 | 17.5 | 17.5 | 39 | 25 |

| DESCRIPTION | MODEL# | STANDARD FABRIC GRADES | | | | | | | | | | | |
|--|--------|------------------------|--------|--------|-----------------|--------|--------|-----------------|--------|--------|--------|--------|--------|
| | | COM | 2 | 3 | 4 | 5 | 6 | 7 | 8 | 9 | 10 | 11 | 12 |
|  <p>Medium Back Armchair Flex Back COM Yardage: 2 Freight Class: 250 Product Weight (lbs.): 34.50 Cubic Feet Per Carton: 13.75</p> | GC7522 | \$1002 | \$1042 | \$1133 | \$1188 | \$1265 | \$1293 | \$1363 | \$1490 | \$1553 | \$1672 | \$1840 | \$1840 |
| | | OVERALL DIMENSIONS | | | SEAT DIMENSIONS | | | BACK DIMENSIONS | | | | | |
| | | W | D | H | W | D | H | W | H | | | | |
| | | | 25.5 | 27 | 41.5 | 20 | 17 | 18 | 20 | 26 | | | |

2 per carton. Specifications and pricing are for 1 chair.

| DESCRIPTION | MODEL# | STANDARD FABRIC GRADES | | | | | | | | | | | |
|---|-----------|------------------------|-------|-------|-----------------|-------|-------|-----------------|--------|--------|--------|--------|--------|
| | | COM | 2 | 3 | 4 | 5 | 6 | 7 | 8 | 9 | 10 | 11 | 12 |
|  <p>Low Back Armchair Flex Back COM Yardage: 1.50 Freight Class: 250 Product Weight (lbs.): 32 Cubic Feet Per Carton: 10.63</p> | GC7524FLX | \$752 | \$781 | \$848 | \$890 | \$949 | \$972 | \$1021 | \$1118 | \$1167 | \$1256 | \$1379 | \$1379 |
| | | OVERALL DIMENSIONS | | | SEAT DIMENSIONS | | | BACK DIMENSIONS | | | | | |
| | | W | D | H | W | D | H | W | H | | | | |
| | | | 23.5 | 26.5 | 38 | 18.5 | 18.5 | 18 | 17.5 | 20 | | | |

2 per carton. Specifications and pricing are for 1 chair.

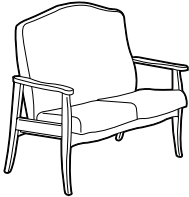
| DESCRIPTION | MODEL# | STANDARD FABRIC GRADES | | | | | | | | | | | |
|--|--------|------------------------|--------|--------|-----------------|--------|--------|-----------------|--------|--------|--------|--------|--------|
| | | COM | 2 | 3 | 4 | 5 | 6 | 7 | 8 | 9 | 10 | 11 | 12 |
|  <p>Medium Back Two Seat Sofa Flex Back COM Yardage: 3.75 Freight Class: 300 Product Weight (lbs.): 68 Cubic Feet Per Carton: 41.50</p> | GC7527 | \$1768 | \$1855 | \$1926 | \$2031 | \$2180 | \$2237 | \$2367 | \$2613 | \$2736 | \$2964 | \$3281 | \$3281 |
| | | OVERALL DIMENSIONS | | | SEAT DIMENSIONS | | | BACK DIMENSIONS | | | | | |
| | | W | D | H | W | D | H | W | H | | | | |
| | | | 45 | 27 | 41.5 | 39 | 17 | 18 | 39 | 26 | | | |

| DESCRIPTION | MODEL# | STANDARD FABRIC GRADES | | | | | | | | | | | | |
|---|--------|------------------------------|--------------------|-------|-------|-----------------|--------|--------|-----------------|--------|--------|--------|--------|--------|
| | | COM | 2 | 3 | 4 | 5 | 6 | 7 | 8 | 9 | 10 | 11 | 12 | |
|  <p>Dining Armchair COM Yardage: 1.25 Freight Class: 300 Product Weight (lbs.): 25 Cubic Feet Per Carton: 13.25</p> | GC7523 | \$705 | \$730 | \$789 | \$823 | \$872 | \$892 | \$935 | \$1014 | \$1053 | \$1127 | \$1233 | \$1233 | |
| | | GC7523-20 20" seat height | \$833 | \$858 | \$926 | \$961 | \$1008 | \$1028 | \$1071 | \$1150 | \$1191 | \$1265 | \$1369 | \$1369 |
| | | | OVERALL DIMENSIONS | | | SEAT DIMENSIONS | | | BACK DIMENSIONS | | | | | |
| W | D | | H | W | D | H | W | H | | | | | | |
| | | | 23 | 23.5 | 33 | 18 | 18.5 | 18 | 19 | 15 | | | | |
| | | | 23 | 23.5 | 35.5 | 18 | 18.5 | 20 | 19 | 15 | | | | |

| DESCRIPTION | MODEL# | STANDARD FABRIC GRADES | | | | | | | | | | | |
|---|-----------|------------------------|--------|--------|-----------------|--------|--------|-----------------|--------|--------|--------|--------|--------|
| | | COM | 2 | 3 | 4 | 5 | 6 | 7 | 8 | 9 | 10 | 11 | 12 |
|  <p>High Back Rocking Chair COM Yardage: 2.50 Freight Class: 250 Product Weight (lbs.): 34 Cubic Feet Per Carton: 15.38</p> | GC7523-21 | \$1153 | \$1211 | \$1258 | \$1329 | \$1428 | \$1466 | \$1553 | \$1716 | \$1798 | \$1950 | \$2162 | \$2162 |
| | | OVERALL DIMENSIONS | | | SEAT DIMENSIONS | | | BACK DIMENSIONS | | | | | |
| | | W | D | H | W | D | H | W | H | | | | |
| | | | 25.5 | 32.5 | 46.5 | 19.5 | 17.5 | 15.5 | 19.5 | 30.5 | | | |

• Non-Slip glides (NS) are NOT available.
2 per carton. Specifications and pricing are for 1 chair.

| DESCRIPTION | MODEL# | STANDARD FABRIC GRADES | | | | | | | | | | | |
|-------------|--------|------------------------|---|---|---|---|---|---|---|---|----|----|----|
| | | COM | 2 | 3 | 4 | 5 | 6 | 7 | 8 | 9 | 10 | 11 | 12 |



GC7523-23

| | | | | | | | | | | | |
|--------|--------|--------|--------|--------|--------|--------|--------|--------|--------|--------|--------|
| \$1104 | \$1144 | \$1177 | \$1226 | \$1296 | \$1322 | \$1383 | \$1498 | \$1555 | \$1662 | \$1810 | \$1810 |
|--------|--------|--------|--------|--------|--------|--------|--------|--------|--------|--------|--------|

| OVERALL DIMENSIONS | | | SEAT DIMENSIONS | | | BACK DIMENSIONS | |
|--------------------|----|------|-----------------|------|------|-----------------|----|
| W | D | H | W | D | H | W | H |
| 25.5 | 32 | 33.5 | 19.5 | 17.5 | 15.5 | 19.5 | 20 |

Low Back Rocking Chair
 COM Yardage: 1.75
 Freight Class: 250
 Product Weight (lbs.): 35
 Cubic Feet Per Carton: 15.38

• Non-Slip glides (NS) are NOT available.

2 per carton. Specifications and pricing are for 1 chair.



GC7524

| | | | | | | | | | | | |
|-------|-------|-------|-------|-------|-------|-------|-------|--------|--------|--------|--------|
| \$652 | \$677 | \$735 | \$768 | \$818 | \$836 | \$878 | \$960 | \$1000 | \$1073 | \$1176 | \$1176 |
|-------|-------|-------|-------|-------|-------|-------|-------|--------|--------|--------|--------|

| OVERALL DIMENSIONS | | | SEAT DIMENSIONS | | | BACK DIMENSIONS | |
|--------------------|----|----|-----------------|------|----|-----------------|----|
| W | D | H | W | D | H | W | H |
| 23.5 | 23 | 33 | 18 | 18.5 | 18 | 19 | 15 |

Low Back Armchair
 COM Yardage: 1.25
 Freight Class: 250
 Product Weight (lbs.): 21.50
 Cubic Feet Per Carton: 10.63

2 per carton. Specifications and pricing are for 1 chair.



GC7525

| | | | | | | | | | | | |
|-------|-------|-------|-------|-------|-------|-------|-------|-------|--------|--------|--------|
| \$586 | \$611 | \$666 | \$700 | \$749 | \$768 | \$810 | \$890 | \$930 | \$1004 | \$1109 | \$1109 |
|-------|-------|-------|-------|-------|-------|-------|-------|-------|--------|--------|--------|

| OVERALL DIMENSIONS | | | SEAT DIMENSIONS | | | BACK DIMENSIONS | |
|--------------------|------|----|-----------------|------|----|-----------------|----|
| W | D | H | W | D | H | W | H |
| 21 | 23.5 | 33 | 18 | 18.5 | 18 | 19 | 15 |

Side Chair
 COM Yardage: 1.25
 Freight Class: 300
 Product Weight (lbs.): 20
 Cubic Feet Per Carton: 10.63

2 per carton. Specifications and pricing are for 1 chair.



GC7526
 16.5" seat height

| | | | | | | | | | | | |
|-------|-------|-------|-------|-------|-------|-------|-------|--------|--------|--------|--------|
| \$652 | \$677 | \$735 | \$768 | \$818 | \$836 | \$878 | \$960 | \$1000 | \$1073 | \$1176 | \$1176 |
|-------|-------|-------|-------|-------|-------|-------|-------|--------|--------|--------|--------|

| OVERALL DIMENSIONS | | | SEAT DIMENSIONS | | | BACK DIMENSIONS | |
|--------------------|------|----|-----------------|------|------|-----------------|----|
| W | D | H | W | D | H | W | H |
| 21 | 23.5 | 32 | 18 | 18.5 | 16.5 | 19 | 15 |

Armchair
 COM Yardage: 1.25
 Freight Class: 250
 Product Weight (lbs.): 21.50
 Cubic Feet Per Carton: 10.63

2 per carton. Specifications and pricing are for 1 chair.

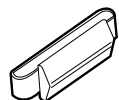

GC-M

| | | | | | | | | | | | |
|------|-------|-------|-------|-------|-------|-------|-------|-------|-------|-------|-------|
| \$89 | \$106 | \$121 | \$142 | \$171 | \$183 | \$209 | \$258 | \$282 | \$328 | \$392 | \$392 |
|------|-------|-------|-------|-------|-------|-------|-------|-------|-------|-------|-------|

| OVERALL DIMENSIONS | | | SEAT DIMENSIONS | | | BACK DIMENSIONS | |
|--------------------|-----|---|-----------------|---|---|-----------------|---|
| W | D | H | W | D | H | W | H |
| 19 | 2.5 | 8 | | | | | |

Neck Cushion for models GC7520-21 and GC7523-21.
 COM Yardage: .75
 Freight Class: 70
 Product Weight (lbs.): 1.50
 Cubic Feet Per Carton: .50

| DESCRIPTION | MODEL# | STANDARD FABRIC GRADES | | | | | | | | | | | |
|-------------|--------|------------------------|---|---|---|---|---|---|---|---|----|----|----|
| | | COM | 2 | 3 | 4 | 5 | 6 | 7 | 8 | 9 | 10 | 11 | 12 |



GCTP1515

| | | | | | | | | | | | |
|-------|-------|-------|-------|-------|-------|-------|-------|-------|-------|-------|-------|
| \$126 | \$141 | \$162 | \$183 | \$213 | \$223 | \$248 | \$297 | \$321 | \$366 | \$428 | \$428 |
|-------|-------|-------|-------|-------|-------|-------|-------|-------|-------|-------|-------|

| OVERALL DIMENSIONS | | | SEAT DIMENSIONS | | | BACK DIMENSIONS | |
|--------------------|----|---|-----------------|---|---|-----------------|---|
| W | D | H | W | D | H | W | H |
| 15 | 15 | 6 | | | | | |

Throw Pillow for GLOBALcare seating models
 COM Yardage: .75
 Freight Class: 70
 Product Weight (lbs.): 1
 Cubic Feet Per Carton: 1.30



reference
textiles + finishes, forms,
terms + conditions, warranty

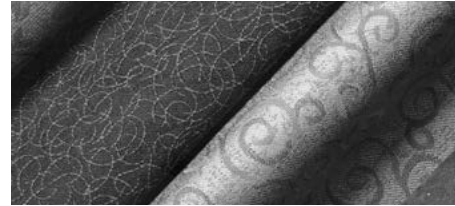

TEXTILES & FINISHES

TEXTILES

For a complete listing of Seating Textiles and Colors, please visit our website at www.thinkglobalcare.com.

For a complete listing of GLOBALcare CARDED textile selections, grading, and ordering samples, please visit the textiles & finishes section at www.thinkglobalcare.com

SEATING FINISHES

METAL

| | | | | | |
|---|------------------|-------------|----------------|-------------|----------------|
| Black (BLK) | Cappuccino (T20) | Mocha (J52) | Platinum (PLT) | Toast (TOA) | Tungsten (TUN) |
| Kalua (KAL) matches T19 -Dark Chocolate | | | | | |

WOOD

| | | | | | |
|-----------------------|-------------------------|---------------------|---------------------|---------------------|---------------------|
| Absolute (AAM) | Brandy Peppercorn (BPM) | Cherry (ACM) | Charcoal Java (CJM) | Cherry Latte (CLM) | Cocoa Vanilla (CVM) |
| Empire Mahogany (EMM) | English Oak (EOM) | Espresso Cafe (ECM) | Fruitwood (TFM) | Gray (HGM) | Harvest Oak (HOM) |
| Harvest Oak* (HOO) | Honey (AHM) | Jet Onyx (JOM) | Light Honey (LHM) | Light Oak* (LOO) | Mahogany (TMM) |
| Maple (AVM) | Medium Walnut (MWM) | Night (ASM) | Sandy Beach (SBM) | Shaker Cherry (SKM) | Silver Oak (SOM) |
| Silver Oak* (SOO) | Walnut (TWM) | WC Cream (WTM) | White (WHM) | Winter Cherry (WCM) | |

Finishes ending with an "M" use Maple wood.

Finishes ending with an "O" use Oak wood.

*Available on Wellness and York Series Only.

SELF-SKINNED URETHANE (SSU) ARMCAPS

| | | | | | |
|-------------|------------------|-------------|-------------|----------------|-------------|
| Black (BLK) | Cappuccino (T20) | Kalua (KAL) | Mocha (J52) | Platinum (PLT) | Toast (TOA) |
|-------------|------------------|-------------|-------------|----------------|-------------|

POLYPROPYLENE ARMCAPS

| | | |
|-------------|----------------|-------------|
| Black (BLK) | Platinum (PLT) | Toast (TOA) |
|-------------|----------------|-------------|

INTERLOCK FINISHES

SELF-SKINNED URETHANE (SSU) ARMCAPS

| | | | | | |
|-------------|------------------|-------------|-------------|----------------|-------------|
| Black (BLK) | Cappuccino (T20) | Kalua (KAL) | Mocha (J52) | Platinum (PLT) | Toast (TOA) |
|-------------|------------------|-------------|-------------|----------------|-------------|

METAL FRAME AND LEGS

| | | | | | |
|------------------|-------------|-------------|----------------|-------------|----------------|
| Cappuccino (T20) | Kalua (KAL) | Mocha (J52) | Platinum (PLT) | Toast (TOA) | Tungsten (TUN) |
|------------------|-------------|-------------|----------------|-------------|----------------|

PVC LEG INSERTS

| | |
|-------------------|-------------------|
| Black Ribbed (BL) | Black Smooth (PL) |
|-------------------|-------------------|

ALUMINUM LEG INSERTS

| | | | | | |
|--------------------|-------------------------|-----------------------|--------------------|--------------------|-----------------------|
| Bronze Ribbed (LB) | Cappuccino Smooth (T20) | Champagne Ribbed (CP) | Kalua Smooth (KAL) | Mocha Smooth (J52) | Platinum Smooth (PLT) |
| Silver Ribbed (AU) | Silver Smooth (PS) | Toast Smooth (TOA) | | | |

WOOD ARMCAPS & LEG INSERTS

| | | | | | |
|-----------------------|-------------------------|---------------------|------------------|--------------------|---------------------|
| Absolute (AAM) | Brandy Peppercorn (BPM) | Charcoal Java (CJM) | Cherry (ACM) | Cherry Latte (CLM) | Cocoa Vanilla (CVM) |
| Empire Mahogany (EMM) | English Oak (EOM) | Espresso Cafe (ECM) | Fruitwood (TFM) | Gray (HGM) | Harvest Oak (HOM) |
| Honey (AHM) | Jet Onyx (JOM) | Light Honey (LHM) | Mahogany (TMM) | Maple (AVM) | Medium Walnut (MWM) |
| Night (ASM) | Sandy Beach (SBM) | Shaker Cherry (SKM) | Silver Oak (SOM) | Walnut (TWM) | WC Cream (WTM) |
| Winter Cherry (WCM) | White (WHM) | | | | |

THERMALLY FUSED LAMINATE TABLE TOPS

| | | | | | |
|-----------------------|--------------------|--------------------------|-----------------------|-----------------------|--------------------------|
| Absolute Acajou (ACJ) | Asian Night (ASN) | Avant Cherry (AWC) | Avant Honey (AWH) | Brushed Cobalt (BRC) | Constellation Java (CSJ) |
| Dark Espresso (DES) | Hayden Grey (HGT) | Quartered Mahogany (QTM) | Shaker Cherry (SKC) | Tiger Fruitwood (FTW) | Tiger Mahogany (TMA) |
| Tiger Maple (TMP) | Tiger Walnut (TWL) | White (WHT) | White Chocolate (WHC) | Winter Cherry (WCR) | |

HIGH PRESSURE LAMINATE TABLE TOPS

| | | | | | |
|--------------------------|-----------------------|-----------------------|---------------------|---------------------------|-----------------------|
| Absolute Acajou (ACJ) | Asian Night (ASN) | Avant Cherry (W357) | Avant Honey (W356) | Brushed Cobalt (BCH) | Clear Maple (CMB) |
| Constellation Java (CJH) | Dark Espresso (W142) | Empire Mahogany (EMB) | Hayden Grey (HGT) | Quartered Mahogany (W313) | Shaker Cherry (SKB) |
| Tiger Fruitwood (W821) | Tiger Mahogany (W822) | Tiger Maple (W820) | Tiger Walnut (W819) | White (S645) | White Chocolate (WHC) |
| Winter Cherry (W149) | | | | | |

TABLE FINISHES

THERMALLY FUSED LAMINATES (AUBRA, GC-BELONG, PRIMACARE, TABLET, FLORAL, ENABLE & OCCASIONAL)

| | | | | | |
|-----------------------|--------------------|--------------------------|-----------------------|-----------------------|--------------------------|
| Absolute Acajou (ACJ) | Asian Night (ASN) | Avant Cherry (AWC) | Avant Honey (AWH) | Brushed Cobalt (BRC) | Constellation Java (CSJ) |
| Dark Espresso (DES) | Hayden Grey (HGT) | Quartered Mahogany (QTM) | Shaker Cherry (SKC) | Tiger Fruitwood (FTW) | Tiger Mahogany (TMA) |
| Tiger Maple (TMP) | Tiger Walnut (TWL) | White (WHT) | White Chocolate (WHC) | Winter Cherry (WCR) | |

HIGH PRESSURE LAMINATES (AUBRA, GC-BELONG, PRIMACARE, TABLET, FLORAL, ENABLE & OCCASIONAL)

| | | | | | |
|--------------------------|-----------------------|-----------------------|---------------------|---------------------------|-----------------------|
| Absolute Acajou (ACJ) | Asian Night (ASN) | Avant Cherry (W357) | Avant Honey (W356) | Brushed Cobalt (BCH) | Clear Maple (CMB) |
| Constellation Java (CJH) | Dark Espresso (W142) | Empire Mahogany (EMB) | Hayden Grey (HGT) | Quartered Mahogany (W313) | Shaker Cherry (SKB) |
| Tiger Fruitwood (W821) | Tiger Mahogany (W822) | Tiger Maple (W820) | Tiger Walnut (W819) | White (S645) | White Chocolate (WHC) |
| Winter Cherry (W149) | | | | | |

WOOD OCCASIONAL TABLES

| | | | | | |
|-----------------------|-------------------------|---------------------|---------------------|---------------------|---------------------|
| Absolute (AAM) | Brandy Peppercorn (BPM) | Cherry (ACM) | Charcoal Java (CJM) | Cherry Latte (CLM) | Cocoa Vanilla (CVM) |
| Empire Mahogany (EMM) | English Oak (EOM) | Espresso Cafe (ECM) | Fruitwood (TFM) | Gray (HGM) | Harvest Oak (HOM) |
| Harvest Oak* (HOO) | Honey (AHM) | Jet Onyx (JOM) | Light Honey (LHM) | Light Oak* (LOO) | Mahogany (TMM) |
| Maple (AVM) | Medium Walnut (MWM) | Night (ASM) | Sandy Beach (SBM) | Shaker Cherry (SKM) | Silver Oak (SOM) |
| Silver Oak* (SOO) | Walnut (TWM) | WC Cream (WTM) | White (WHM) | Winter Cherry (WCM) | |

*Available on Wellness Series Only.

Please refer to the Tables section for availability and coordinating Wood Base & Leg Finishes.

METAL TABLE LEGS

Please refer to the specific table series for finish listings.

PERSONAL ROOM FURNITURE FINISHES

ALDON - THERMALLY FUSED LAMINATE

| | | | | | |
|-----------------------|--------------------------|---------------------|-----------------------|--------------------------|---------------------|
| Absolute Acajou (ACJ) | Asian Night (ASN) | Avant Cherry (AWC) | Avant Honey (AWH) | Constellation Java (CSJ) | Dark Espresso (DES) |
| Hayden Grey (HGT) | Quartered Mahogany (QTM) | Shaker Cherry (SKC) | Tiger Fruitwood (FTW) | Tiger Mahogany (TMA) | |
| Tiger Maple (TMP) | Tiger Walnut (TWL) | White (WHT) | White Chocolate (WHC) | Winter Cherry (WCR) | |

SONOMA

| | | | | | |
|-----------------------|----------------------|-----------------------|--------------------|-----------------------|-----------------------|
| Absolute Acajou (ACJ) | Asian Night (ASN) | Avant Cherry (AWC) | Avant Honey (AHB) | Black (BLK) | Clear Maple (CMB) |
| Dark Espresso (DES) | Designer White (DWT) | Empire Mahogany (EMB) | Hayden Grey (HGT) | River Cherry (RCL) | Satin Stainless (SSL) |
| Shaker Cherry (SKB) | Storm Grey (SOG) | Tiger Maple (TMP) | Tiger Walnut (TWL) | White Chocolate (WHC) | |

SONOMA - ALUMINUM EXTRUSIONS

| | | | | | |
|----------------|---------------|-------------|-------------|-------------|------------|
| Black (BLK) | Charcoal (CG) | Nevada (NV) | Sierra (SC) | Silver (SL) | Taupe (TP) |
| Tungsten (TUN) | | | | | |

For a complete listing of Globalcare textiles and finishes, please refer to our website at www.thinkglobalcare.com.

TEXTILES & FINISHES

TWO GRADES COMBINATION CHART - GLOBAL

FIRST TEXTILE SELECTED

| | | 1 | 2 | 3 | 4 | 5 | 6 | 7 | 8 | 9 | 10 | 11 | 12 | 13 | 14 | 15 | 16 | 17 | 18 |
|-------------------------|----|----|----|----|----|----|----|----|----|----|----|----|----|----|----|----|----|----|----|
| SECOND TEXTILE SELECTED | 1 | 1 | | | | | | | | | | | | | | | | | |
| | 2 | 2 | 2 | | | | | | | | | | | | | | | | |
| | 3 | 3 | 3 | 3 | | | | | | | | | | | | | | | |
| | 4 | 4 | 4 | 4 | 4 | | | | | | | | | | | | | | |
| | 5 | 4 | 4 | 5 | 5 | 5 | | | | | | | | | | | | | |
| | 6 | 5 | 5 | 5 | 6 | 6 | 6 | | | | | | | | | | | | |
| | 7 | 6 | 6 | 6 | 6 | 7 | 7 | 7 | | | | | | | | | | | |
| | 8 | 6 | 6 | 7 | 7 | 7 | 8 | 8 | 8 | | | | | | | | | | |
| | 9 | 7 | 7 | 7 | 8 | 8 | 8 | 9 | 9 | 9 | | | | | | | | | |
| | 10 | 7 | 7 | 8 | 8 | 9 | 9 | 9 | 10 | 10 | 10 | | | | | | | | |
| | 11 | 8 | 8 | 9 | 9 | 9 | 10 | 10 | 10 | 11 | 11 | 11 | | | | | | | |
| | 12 | 9 | 9 | 10 | 10 | 10 | 10 | 11 | 11 | 11 | 12 | 12 | 12 | | | | | | |
| | 13 | 10 | 10 | 11 | 11 | 11 | 11 | 12 | 12 | 12 | 12 | 13 | 13 | 13 | | | | | |
| | 14 | 11 | 11 | 12 | 12 | 12 | 12 | 12 | 13 | 13 | 13 | 13 | 14 | 14 | 14 | | | | |
| | 15 | 12 | 12 | 13 | 13 | 13 | 13 | 13 | 13 | 14 | 14 | 14 | 14 | 15 | 15 | 15 | | | |
| | 16 | 13 | 13 | 13 | 14 | 14 | 14 | 14 | 14 | 14 | 14 | 15 | 15 | 15 | 16 | 16 | 16 | | |
| | 17 | 14 | 14 | 14 | 14 | 15 | 15 | 15 | 15 | 15 | 15 | 16 | 16 | 16 | 16 | 17 | 17 | 17 | |
| | 18 | 15 | 15 | 15 | 15 | 15 | 16 | 16 | 16 | 16 | 16 | 16 | 17 | 17 | 17 | 17 | 18 | 18 | 18 |

ALTERNATIVE TEXTILE OPTIONS

GPM - Global Purchaes (customer specified) Material

For a greater selection of upholstery options, please visit the following websites. Global will be happy to provide as a G.P.M.

| Supplier's Name | Website | Phone number to call for Memo Samples |
|-------------------|--|---------------------------------------|
| CF Stinson | www.cfstinson.com | 800.841.6279 |
| Maharam Textiles | www.maharam.com | 800.645.3943 |
| Mayer Fabrics | www.mayerfabrics.com | 800.428.4415 |
| Momentum Textiles | www.themomgroup.com | 800.366.6839 |
| Morbern | www.morbern.com | 336.883.4332 |

To access any of the selected suppliers' textiles for use on GLOBALcare products as a G.P.M. (Global Purchases [customer specified] Material), please contact your GLOBALcare Representative or GLOBALcare Customer Care Department.

NOTE: Please contact Global Customer Care for inquiries regarding grading as a G.P.M. on any selected for use from the above mentioned suppliers.

GLOBALCARE C.O.M. AUTHORIZATION FORM

CUSTOMER INFORMATION

To be completed by the dealer/design firm. Use one form per textile. Incomplete information may delay or prevent approval.

| | | | |
|-----------------------------------|--------|--|------|
| A+D/Dealer/Company Name: | | Contact: | |
| Billing Address: | | Phone: | |
| City: | State: | Zip: | Fax: |
| End-User/Project Name: | | End-User/Project Registered? YES NO If YES, The Global Quote#: | |
| Local Global Distribution Center: | | Date: | |

TEXTILE APPLICATION INFORMATION

| SEATING MODEL NUMBER | QUANTITY | SPECIAL INSTRUCTIONS |
|----------------------|----------|----------------------|
| | | |
| | | |
| | | |

Textile Name (Series/Style #):

Textile Color Name and Description:

Country of Origin:

Mill or Manufacturer's Name:

Textile Content (% Cotton, % Poly, % Wool, etc.):

Textile Width:

Pattern Repeat: VERTICAL HORIZONTAL

Rail Roaded? YES NO

TEXTILE DIRECTION



STAPLE FABRIC TO THIS FORM IN THE DIRECTION IN WHICH THE FABRIC IS TO BE UPHOLSTERED WITH THE TOP OF THIS PAGE BEING THE SAME AS THE TOP OF THE CHAIR.

NEW TEXTILE

Attached textile sample
(Minimum 5"x 5" Max 12"x 12")
In correct DIRECTION and SIDE.

PREVIOUSLY APPROVED TEXTILE

Fax completed form to: 856.596.5684

MAIL FORM AND TEXTILE SAMPLE ONLY TO:

GLOBAL - COM Department
17 West Stow Road
Marlton, NJ 08053 | 856.596.3390

Please contact your local GLOBAL Distribution Center for status of all COM requests. When textile is approved and an authorization number issued, a set of shipping instructions will be faxed or e-mailed to you.

Approved textiles are to be shipped to the address that will be included with instructions. Do not ship textiles to the address on this form. Dealer is responsible for the shipping expenses. Brokerage fees will be paid for by Global. However, duties imposed by North American Governments related to textile materials, content and Country of Origin, additional fees may apply and will be billed separately.

Please Note: C.O.M Textiles may not be shipped without shipping documents. GLOBAL is not responsible for any material shipped without the authorization number.

Please be advised that Global has phased out the use of textiles that contain certain Phthalates, including but not limited to: DEHP (di (2-ethylhexyl) phthalate), DBP (di-n-butyl phthalate), BBP (butyl benzyl phthalate) and DINP (di-isononyl phthalate) (collectively the "Listed Chemicals"). The Listed Chemicals are used in certain types of vinyls. Global cannot accept orders for textiles that contain the Listed Chemicals, if such orders are to be shipped to the U.S.A. or are intended for customer in the U.S.A. If you are not sure if the C.O.M you have selected contains the Listed Chemicals, please contact the manufacturer or supplier of the fabric to verify.

GLOBAL AUTHORIZATION FORM (TO BE COMPLETED BY GLOBAL)

CAN#:

TEXTILE YARDAGE (REQUIRED FOR THE ORDER):

GU CODE:

SIGNATURE: _____

PRINT NAME: _____

DATE: _____



LEVEL 3 CERTIFIED
Many programs in various categories



LEED PARTNERSHIP PROGRAM
Products can help you earn credits



GREENGUARD CERTIFIED
Children & Schools Certified

THE ENVIRONMENT We believe now more than ever, that it is our responsibility to protect the environment and our precious natural resources for future generations. The growing importance of energy and environmental concerns continues to challenge us in this ever changing marketplace.

As an industry leader, Global continues to take proactive steps towards reducing the negative impacts on the environment. We are building "healthier" offices; investing in Research & Development and new technologies; reducing waste and the consumption of energy; and improving the quality of the air we breathe, all which can have a significant impact on our quality of life.



Epoxy Powder coating process is solvent free. No harmful VOC's or lead. No toxins are released into the atmosphere.

Global's recycled fabrics offer affordable, environmentally responsible alternatives to commercial textiles. We recycle 35,000 lbs of fabric offcuts weekly.



powder paint process:
98% paint recovery and reuse

more recycled fabric
less to the landfill

talk to us about our
leed partnership program

we've diverted
90% of our wood waste from landfill in four years



Global has the products and resources to help your projects achieve LEED certification.

New technology allows us to reduce glue usage by 50%. In addition, our polyurethane glue reduces emissions and requires less energy to apply.

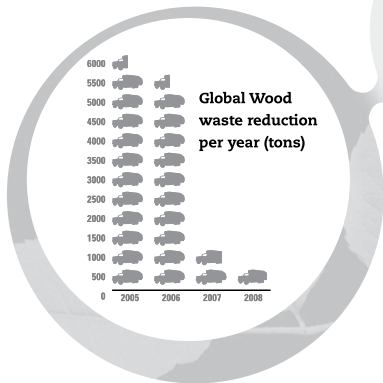

For further information on Global's environmental initiatives, please visit <http://www.globaltotaloffice.com/enviro/>



TERMS & CONDITIONS

GLOBALcare is a division of Global Industries, Inc. ("Global") focused on providing furniture products for use in healthcare environments and is a member of the Global Group.

This illustrated price list has been designed to facilitate fast reference and easy use. All products are categorized into product series groupings, and are listed numerically by product number within their categories. The line drawings match actual photographs (where possible) to aid in instant recognition of the total range within a series.

Sales of GLOBALcare products are made only on GLOBALcare's standard terms and conditions of sale which are contained in this Price Book. The "Purchaser" in these Terms & Conditions shall mean dealers and those who purchase directly from GLOBALcare for re-sale. These standard terms and conditions may be modified or supplemented only by a separately written document signed by GLOBALcare's authorized personnel at its head office in Marlton, NJ. Any term or condition contained in any purchase order or other form used by the Purchaser to order goods (including standard, printed language) which is different from, in addition to, or in any way inconsistent with GLOBALcare's standard terms and conditions shall be of no force or effect whatsoever.

All illustrations, specifications and prices in this book are based on the latest product information available at the time of publication. GLOBALcare reserves the right to make changes, at any time and without prior notice to prices, colors, materials, specifications and models offered.

DESCRIPTION

Each product shown or described in this price list is standard GLOBALcare product. Variations are noted at the beginning or end of each series. Any variations from what is standard may require additional delivery time and cost and may affect the warranty given. Sizes and weights shown are approximate and are subject to slight changes from time to time.

PRICES AND PAYMENT

The prices shown in this book, as well as those quoted by GLOBALcare, are in United States dollars for orders shipped to destinations in the U.S., Mexico and Puerto Rico.

If shipping date requested is more than 90 days from date of order, GLOBALcare shall have the right to use published list prices effective at the time of shipment.

Orders are invoiced at the time of shipment. **Terms of payment are net 30 days from date of invoice (1% 15 days) unless otherwise stated.** The Purchaser agrees that GLOBALcare shall have the right to enforce a charge amounting to 1.5% per month (18% per year) on invoices outstanding more than 30 days.

If the Purchaser's most recent annual net volume is less than \$5,000, payment must be made in advance. All orders are subject to the Purchaser complying with GLOBALcare's prevailing credit policy. Any products sold by GLOBALcare shall remain the personal property of GLOBALcare until fully paid.

Prices are suggested list prices only and are subject to change without notice. GLOBALcare will, however, attempt to keep the Purchaser up-to-date on all developments including price changes.

TAXES

All prices shown in this book are exclusive of sales, use, excise and other applicable taxes and are the Purchaser's responsibility as per the invoice issued by Global on behalf of GLOBALcare. If Purchaser claims an exemption from such taxes, it shall be the Purchaser's responsibility to furnish GLOBALcare with an appropriate exemption certificate at time of order.

ORDERING INFORMATION

To avoid errors and/or duplication GLOBALcare requires that all orders be submitted in writing. All orders submitted to GLOBALcare in writing will be acknowledged on Global's acknowledgement forms governing the transaction. The details appearing on this acknowledgement will describe the items to be shipped and the approximate shipping date. It is the Purchaser's responsibility to determine that the information in the acknowledgment is correct. In the event of an error, the Purchaser must notify GLOBALcare immediately by telephone followed by written confirmation. Shipping dates are assigned to orders based on the item having the longest manufacturing lead time.

When ordering, please provide the following information:

1. Account number (if possible)
2. P.O. number
3. "Bill to" and "ship to" name and address
4. Complete model number
5. Description
6. Options
 - a. Upholstery fabric type and color (specify by name and number)
 - b. Color of paint finish, laminate or wood (if applicable)
 - c. Trim options (frame)
 - d. Arms
 - e. Base, Casters
 - f. Mechanism
 - g. Accessories

The Purchaser is responsible for providing correct information when placing an order. Orders with incorrect information (finish, etc.) will be scheduled for manufacturing upon receipt of complete information.

All phone orders must be confirmed in writing by the customer within 7 days.

To prevent a delay in processing orders, please specify delivery routing.

CHANGES AND CANCELLATIONS

After the date of GLOBALcare's acknowledgment of a Purchaser's order, the order may not be changed or cancelled by Purchaser without the written consent of GLOBALcare. Special order items, C.O.M. and fabric-covered items already in production are not subject to change or cancellation under any circumstances. Fabric-covered items are considered to be in production once the fabric is scheduled for cutting.

ERRORS AND OMISSIONS

All quotations, acknowledgements and invoices are subject to corrections for any errors and omissions.

FINISHES

Seating Finishes

Where painted frames are not a standard color, there is a one time charge of \$578.00 list price per order for custom wood staining/color matching. Restrictions may apply. The customer must provide a 3"x 3" color chip/sample for review and approval. Non-standard finishes must be approved by Global prior to acceptance of order.

Frame Finishes

Because the distinctive characteristics and the nature of wood products cause variations, exact matches are not always possible.

All exposed wood surfaces and frames are finished with an anti-microbial, anti-bacterial lacquer. The anti-microbial, anti-bacterial additive provides effective protection by inhibiting the growth of bacteria and fungal spores.

GLOBALcare coordinates its finishes program between marketing divisions within the Global Group to match products

as best as possible when same finishes are specified. However, GLOBALcare will not be held responsible if the finishes cannot be matched.

C.O.M. (Customers Own Material)

Use of Customer's Own Material must be approved by GLOBALcare prior to acceptance of order. Please refer to the inside back cover of this Price Book and fill out the Authorization Request Form. Photocopy and use this form as often as necessary. The customer must provide a 12" x 12" fabric sample and advise how the fabric is to be applied and quantity of fabric being sent. Fabric yardage requirement will be advised by factory, and additional yardage may be required if pattern requires matching. Send fabric to your Customer Service Representative upon approval from GLOBALcare. If C.O.M. is difficult to apply or if product is required to be modified, extra charges shall apply. GLOBALcare reserves the right to cancel an order at any time if C.O.M. is inadequate for any reason. Customer's Own Material must be shipped freight and duties paid to our factory. Such shipment must be fully identified with Purchaser's order number, RGA # provided by Global, and the item for which material is intended. Performance of C.O.M. when applied to product is the sole responsibility of the Purchaser. GLOBALcare's standard product warranty shall not apply to C.O.M. Use of C.O.M. will not reduce the published list price.

C.S.M. (Customer Specified Material)

Use of Customer Specified Material must be approved by GLOBALcare prior to acceptance of order. If C.S.M. is difficult to apply or if product is required to be modified, extra charges shall apply. GLOBALcare reserves the right to cancel an order at any time if C.S.M. is inadequate for any reason. Performance of C.S.M. when applied to product is the sole responsibility of the Purchaser. GLOBALcare's standard product warranty shall not apply to C.S.M.

VINYL & FABRIC GRADING

All products are priced according to their standard vinyl and fabric grade. Lower grade vinyls and fabrics are available (unless otherwise specified) at same price as standard. The listing of prices for each model indicates a price for each of the upholstery grades. Prices are based on yardage in imperial measurements. Please refer to the Textiles & Finishes section of the GLOBALcare website for the most up to date listing.

UPHOLSTERY COVERINGS

Slight variations in color may occur between dye lots. Although GLOBALcare attempts to minimize these variances, they do occur and must be accepted as normal and will not be considered defects.

YARDAGE

Required yardage (ydg) is based on unmatched materials with widths of 54" for seating. Yardage calculations are based on imperial measurements.

WEIGHT

This figure indicates the weight of one part and its packaging, regardless of the number of parts shipped in a single carton. In order to estimate the approximate shipping weight for an order, you have to multiply the indicated weight by the number of parts per carton. (e.g. if a part weight is 10 lbs. and is shipped 4 per carton, shipment weight should be calculated as: 4 x 10 = 40 lbs.)

CUBIC MEASURE

The stated cubage is an approximate cubic foot measure to calculate freight costs. The figure shown is the volume for the total shipment of a part (e.g. if a part is sent in 2 cartons the volume indicated reflects the cubage of both cartons together) and is subject to change without notice. It is most economical to purchase the specified number per carton.

DELAYS

Global's shipping confirmation will state a shipping date which is GLOBALcare's best estimate at the time the order is acknowledged. However, GLOBALcare shall not incur any obligation or liability to Purchaser for failure to ship by specified date unless GLOBALcare has agreed to an unequivocal shipping date in a separately signed written document executed by its authorized personnel at its head office. In addition, GLOBALcare shall not be liable for any loss or damage resulting from any delay or failure in shipment or other failure to perform all or any part of the agreement between the parties with respect to the goods shown on the face of the order acknowledgement where such delay, failure, loss or damage is the proximate result of any act of any governmental authority or political subdivision thereof, revolution, riot, civil disorder or disturbance, delay or default in transportation, electrical power failure, strike disputes among or between labor unions or other labor disputes, delay or inability in obtaining materials and facilities, fire, flood, act of God or any cause not within the reasonable control of GLOBALcare, whether of the class of causes enumerated or otherwise.

SUSPENSION

In the event that the Purchaser defaults in the payment of any sum due to Global, or in the event the Purchaser's financial condition becomes unsatisfactory to GLOBALcare, GLOBALcare shall have the right to defer or discontinue shipment of any goods until such time as the default is cured or the Purchaser provides assurance of payment to Global.

F.O.B.

F.O.B. point is GLOBALcare's Factory, Downsview, Ontario, Canada, or any Global Regional Distribution Center.

SERVICE

Service requests are normally the responsibility of GLOBALcare's authorized dealers. Where this cannot be accomplished on a local level, service problems should be referred to GLOBALcare's Customer Service Department in the nearest distribution center.

RETURNS

No returns of goods will be accepted without written consent and shipping instruction of GLOBALcare. A minimum restocking charge of 35% is made on all authorized returns for credit or refund, provided goods are received by Global in the condition in which they left the factory. This may increase depending on the type of product. GLOBALcare's Return Goods Authorization (R.G.A.) numbers must appear prominently on all authorized returns. GLOBALcare will not be responsible for freight costs. No credit will be given if goods cannot be reused as new. Special order items and C.O.M. products are in no event subject to return. All returns must be approved and authorized in writing by GLOBALcare Customer Service. GLOBALcare reserves the right to refuse delivery of any unauthorized returns.

STORAGE CHARGE

Global reserves the right to assess storage charges if a customer does not accept shipment of an order within a week of shipment or requested ship date.

CLAIMS

All goods are sold F.O.B. plant or GLOBALcare Distribution Center. GLOBALcare is not responsible for damage which occurs in transit (or in storage). The carrier signs for all goods received in apparently good order. It is the Purchaser's responsibility to examine goods upon receipt and to file any claims with the carrier for losses or damage to the product occurring during transit, including concealed damage.

Any claims made against GLOBALcare for apparent defects, errors or shortages must be made by the Purchaser, in writing, within 15 working days after any delivery. Failure by the

Purchaser to make any claim against GLOBALcare within 15 days shall constitute acceptance of the goods and a waiver of any apparent defects, errors or shortages.

COMBINED SHIPMENTS

GLOBALcare will make every effort to combine shipments and orders on written request. However, GLOBALcare cannot be held responsible where such request is not complied with.

UPS SHIPMENTS

Seating products marked with a UPS symbol next to the CARTON COUNT are packaged for UPS-able shipments.

OFFER OF SALE

Possession of this price list or any other literature shall not imply GLOBALcare's willingness to sell to the holder and shall not be construed as a direct offer of sale.

If a conflict arises between: (i) prices found in software support packages furnished to the customer by Global or by any other source on behalf of Global; and (ii) Global's current printed price lists, then the printed price list shall prevail.

TESTING QUALIFICATIONS

Many GLOBALcare products pass or exceed the most stringent testing procedures. Where tests are significant, they are marked as C.G.S.B. (Canadian General Standards Board) qualified and as passing ANSI/BIFMA (American National Standards Institute/Business Institutional Furniture Manufacturer's Association).

DISCLAIMER

All dimensions are in inches. Prices shown are current manufacturer's suggested list prices at the time of printing. All applicable taxes are extra. Descriptions, specifications and prices are subject to change without notice. Errors and omissions are subject to correction.

COPYRIGHT

All catalogs, photographs, drawings, price lists and other printed material are protected by copyright. All rights reserved.

TRADEMARKS

All trademarks are owned by GLOBALcare and Global Total Office other than OBUSFORME™ which is owned by OBUSFORME LTD. and are used under license and MORCARE™ which is owned by MORBERN INC. OBUSFORME® and the distinctive backrest design are registered trademarks of OBUSFORME LTD.

DESIGNS

Many of the products produced by GLOBALcare are protected by Industrial Design Registrations, Design Patents and/or Patents. Designs and specifications are subject to change, discontinuance or additions without notice.

FLAMMABILITY

The Global branded carded fabrics and foam used in GLOBALcare products meet the requirements of California TB117. This is a component test and measures the flame resistance of fabric and foam. Many products are also available with CAL133 certification. This is a composite test of a completed product and is more stringent than the CAL117 component test. It is typically required in public use occupancy buildings. There is an additional cost to certify an upholstered product to the CAL133 standard. Those costs and additional information are noted below.

When a product cannot be certified to CAL133, due to the composition of the fabric selected a customer may still choose to have an upholstered piece manufactured with a fire barrier. This is not a replacement for CAL133 certification but may, give piece of mind to a customer who is looking to maximize the fire retardancy of a product not available with CAL133 certification.

Costs for the optional fire barrier lining (AF) are listed under each series' notes.

CAL133:

This test is a composite test conducted on a complete chair. Should you require product to meet CAL133 Performance Standard, the covering and complete product combination must pass. When ordering product that must pass CAL133 Performance Standard, the FIRE BARRIER must be used as a lining to the upholstery on the product. Please note the FIRE BARRIER does not alone ensure the product will pass the required testing. Any change to the finished product means a retest is necessary. Compliance is acknowledged when a certificate is issued by the testing facility that is licensed to conduct this test. To pass the CAL133 test, a burner is placed where the inside seat and back meet. The burner is ignited and extinguished for a specific period of time. To pass this test the completed product must be self-extinguishing and must meet specific heat, smoke and carbon monoxide emission standards. To have product tested and certified the cost to the customer is as follows:

- 1) Cost of product, based on using a graded in or C.S.M. textile.
- 2) Cost of C.O.M. if a standard Global graded in textile is not used.
- 3) Cost of test = \$800.00 (approximate) for the lab. This test is performed by a local qualified and licensed facility.

NOTE: These costs apply whether the product passes or fails. If it passes, a CAL133 certificate will be issued. Failure would result in starting at step 1, including the costs. Many fabric/vinyl compositions are highly combustible, preventing them from achieving CAL133 Performance Standards.

Following is the list price upcharge information for products that can be certified to California TB133.

Fabric, Vinyl or Leather: Add **\$65.00 list per yard** upcharge

This list price book is effective as of October 1st, 2013.

For periodic updates, please check the PDF at www.globalindustries.com. After login, select INFORMATION, then GLOBALcare, and then PRICE BOOK/PRICING.

LIFETIME WARRANTY

GLOBALcare warrants that all commercial products are free from defects in material and workmanship, for the life of the product, to the original purchaser.

GLOBALcare will repair or replace, at Global's option, as the sole remedy for any defect covered by the warranty. The warranty applies to products manufactured after January 1, 2012.

GENERAL GLOBALCARE SEATING

GLOBALcare's warranty for general commercial seating covers all chair components including bases, casters, glides, frames, arms, plastic seats, backs and other structural components.

Exceptions to the warranty for general commercial seating are as follows:

- Foam, textiles (as sampled on Global branded and textile program cards) are warranted for five (5) Years
- Control mechanisms and pneumatic cylinders are warranted for ten (10) Years

The warranty applies only to single shift, standard commercial usage, defined as a standard eight (8) hour day, forty (40) hour week for users weighing up to 300 pounds.

HEAVY DUTY SEATING

GLOBALcare offers products designed for multiple shift applications (24 hours a day / 7 days a week) and larger individuals weighing up to 350, 500 and/or 750 pounds (depending on series and/or model). GLOBALcare warrants these products for ten (10) years to the original purchaser. All components (including control mechanisms, pneumatic cylinders, bases, casters, glides, frames, arms, plastic seats/backs, etc.) are covered for 24/7 applications under the warranty. The exceptions are foam and textiles, which are covered for five (5) years. Textiles on these products must exceed 100,000 double rubs for the textile portion of the warranty to apply. Heavy Duty product series that apply under this warranty currently include: Interlock, Nourish and Bariatric models of Aubra, Careflex, GC-Comet, Primacare, Primacare HT, Strand and GC-Belong.

FABRICS

GLOBAL warrants fabrics, vinyls and leather products marketed on Global, Global Branded cards and GLOBALcare Branded cards. GLOBALcare carded Branded textile alliance programs are currently with CF Stinson, Maharam, Mayer, Momentum and Morbern, and are warranted for five (5) years. Global does not warrant COM (Customer Own Materials) or GPM (Global Purchased Materials) that are customer's own specified materials, or graded-in and purchased by Global for a customer. For GPM or COM products, please contact the textile supplier for performance information and warranty details.

FILES, DESKS, MODULAR FURNITURE, TABLES, PANELS & ACCESSORIES

GLOBALcare warrants all components of metal storage and filing, laminate and wood veneer desks, laminate and wood veneer tables, metal leg components and panels for the lifetime of the product to the original purchaser.

SEATING WARRANTY SUMMARY

| Seating Type | Components Warranty For Original Purchaser | Use Time For Warranty Coverage | Exceptions |
|----------------------------|--|--------------------------------|--|
| General GLOBALcare Seating | Lifetime | 8 Hours/5 Days Per Week | Foam/Textiles/Mesh/Electrical Devices - 5 Years Control Mechanisms - 12 Years |
| Heavy Duty Seating | 10 Years | 24 Hours/7 Days Per Week | Foam/Textiles - 5 Years |

FILES, DESKS, MODULAR FURNITURE, TABLES, PANELS & ACCESSORIES WARRANTY SUMMARY

| Product Type | Components Warranty For Original Purchaser | Exceptions |
|--|--|--|
| Metal Storage and Filing | Lifetime | None |
| Laminate/Wood Veneer Desks, Sonoma and Modular Furniture | Lifetime | Tackboard Textiles , Electrical Devices, Task Lights - 5 Years |
| Boardroom, Conference and Training Tables, Occasional Tables | Lifetime | Electrical Devices - 5 Years |

GLOBAL'S WARRANTY DOES NOT APPLY (FOR ANY PRODUCT CATEGORY) TO THE FOLLOWING:

- Failures due to wear and tear
- Failures which result from negligence, abuse, accident or misuse
- Failure to apply, install or maintain products according to GLOBALcare's written instructions and warnings
- Modifications, attachments or repair methods not approved by GLOBALcare
- Damage caused by a carrier in transit, or delivery/installation contractors
- The matching of colors, grains or textures (wood, leather, etc.) of natural materials and color matching of textiles
- Products exposed to extreme hot or cold temperatures or excessively dry or humid environments
- Colorfastness or the matching of color of textiles
- Damage by markings or staining; damage by sharp objects or imprinting from instruments
- Damage to textiles or laminate and wood surfaces/edges from exposure to sunlight (including UV rays)
- Products used for rental purposes

Global and GLOBALcare's warranty does not cover the costs of transportation or labor. Repair or replacement will be at GLOBALcare's option.

GLOBALcare makes no warranty that any of its products are suitable for any particular purpose and makes no other warranties, express or implied, other than those set out here. As codes and standards vary from one jurisdiction to another, references to compliance are solely for convenience and without any representation as to accuracy or suitability. Users must verify the suitability of such information or product for their specific application. In no event shall GLOBALcare be liable in either tort or contract for any loss or direct, special, incidental, consequential, or exemplary damages.

GLOBALcare's warranty applies to products sold within the United States of America, Mexico, the Commonwealth of Puerto Rico and Canada.



GLOBALcare



1.800.220.1900 www.thinkglobalcare.com Effective January 1, 2017